

TM30G03DF

N+P-Channel Enhancement Mode Mosfet

<p>General Description</p> <ul style="list-style-type: none"> • Low $R_{DS(ON)}$ • RoHS and Halogen-Free Compliant <p>Applications</p> <ul style="list-style-type: none"> • Load switch • PWM 	<p>General Features</p> <p>N Channel $V_{DS} = 30V, I_D = 30A$ $R_{DS(ON)} = 9m\Omega @ V_{GS} = 10V$</p> <p>P Channel $V_{DS} = -30V, I_D = -30A$ $R_{DS(ON)} = 19m\Omega @ V_{GS} = -10V$</p> <p>100% UIS Tested 100% R_g Tested</p> 
--	---

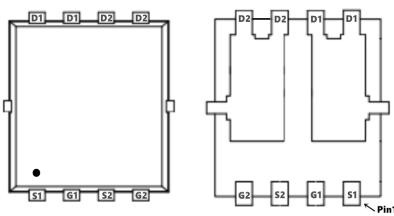

DF:DFN3x3_8L

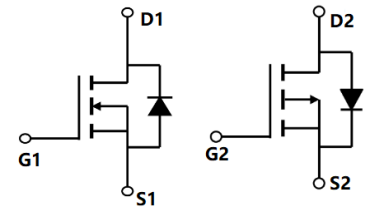
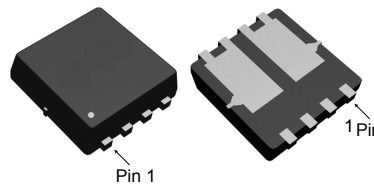

Marking :30G03 OR Z4616A

Absolute Maximum Ratings: ($T_c = 25^\circ C$ unless otherwise noted)

Symbol	Parameter	N-Channel	P-Channel	Units
V_{DS}	Drain-Source Voltage	30	-30	V
V_{GS}	Gate-Source Voltage	± 20	± 20	V
I_D	Continuous Drain Current- $T_c = 25^\circ C$	30	-30	A
	Continuous Drain Current- $T_c = 100^\circ C$	7.2	-7.2	
I_{DM}	Pulsed Drain Current ^{note1}	44	-44	A
E_{AS}	Single Pulsed Avalanche Energy ^{note2}	20	25	mJ
P_D	Power Dissipation - $T_c = 25^\circ C$	3.3	5.6	W
T_J, T_{STG}	Operating and Storage Junction Temperature Range	-55 to +150		$^\circ C$

Thermal Characteristics:

Symbol	Parameter	N-CH	P-CH	Units
$R_{\theta JA}$	Thermal Resistance, Junction to Ambient	38	22	$^\circ C/W$

TM30G03DF

N+P-Channel Enhancement Mode Mosfet

N-Channel Electrical Characteristics: ($T_C=25^\circ\text{C}$ unless otherwise noted)

Symbol	Parameter	Conditions	Min	Typ	Max	Units
Off Characteristics						
BV_{DSS}	Drain-Source Breakdown Voltage	$V_{GS}=0V, I_D=250\ \mu\text{A}$	30	---	---	V
I_{DSS}	Zero Gate Voltage Drain Current	$V_{GS}=0V, V_{DS}=30V$	---	---	1	μA
I_{GSS}	Gate-Source Leakage Current	$V_{GS}=\pm 20V, V_{DS}=0A$	---	---	± 100	nA
On Characteristics³						
V_{GS(th)}	GATE-Source Threshold Voltage	$V_{GS}=V_{DS}, I_D=250\ \mu\text{A}$	1	1.4	2.5	V
R_{DS(on)}	Drain-Source On Resistance ^{note3}	$V_{GS}=10V, I_D=10A$	---	9	15	m Ω
		$V_{GS}=4.5V, I_D=5A$	---	16	22	
Dynamic Characteristics⁴						
C_{iss}	Input Capacitance	$V_{DS}=15V, V_{GS}=0V, f=1\text{MHz}$	---	580	---	pF
C_{oss}	Output Capacitance		---	110	---	
C_{rss}	Reverse Transfer Capacitance		---	92	---	
Q_g	Gate Charge	$V_{GS}=10V, V_{DS}=15V, I_D=10A$	---	13	---	nC
Q_{gs}	Gate-Source Charge		---	4.5	---	
Q_{gd}	Gate-Drain Charge		---	3.3	---	
Switching Characteristics⁴						
t_{d(on)}	Turn-On Delay Time	$V_{DS}=30V, I_D=10A, R_{REN}=3\ \Omega, V_{GS}=10V$	---	3	---	ns
t_r	Rise Time		---	6	---	ns
t_{d(off)}	Turn-Off Delay Time		---	19	---	ns
t_f	Fall Time		---	5	---	ns
Drain-Source Diode Characteristics						
I_S	Continuous Drain to Source Diode	---	---	---	30	A
I_{SM}	Pulsed Drain to Source Diode	---	---	---	44	A
V_{SD}	Source-Drain Diode Forward Voltage	$V_{GS}=0V, I_S=11A$	---	0.8	1.2	V
t_{rr}	Body Diode Reverse Recovery Time	$I_F=11A, dI/dt=100A/\ \mu\text{s}$	---	7	---	ns
Q_{rr}	Body Diode Reverse Recovery		---	5.9	---	nC

Notes:

1. Repetitive Rating: Pulse Width Limited by Maximum Junction Temperature
2. EAS condition : $T_J=25^\circ\text{C}, V_{DD}=15V, V_G=10V, L=0.5\text{mH}, R_g=25\Omega, I_{AS}=9A$
 $T_J=25^\circ\text{C}, V_{DD}= -15V, V_G= -10V, L=0.5\text{mH}, R_g=25\Omega, I_{AS}= -10A$
3. Pulse Test: Pulse Width $\leq 300\mu\text{s}$, Duty Cycle $\leq 0.5\%$



TM30G03DF

N+P-Channel Enhancement Mode Mosfet

Typical Performance Characteristics-N

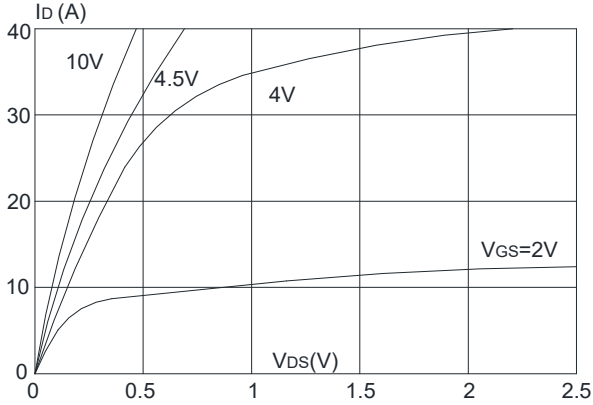

Figure 1: Output Characteristics

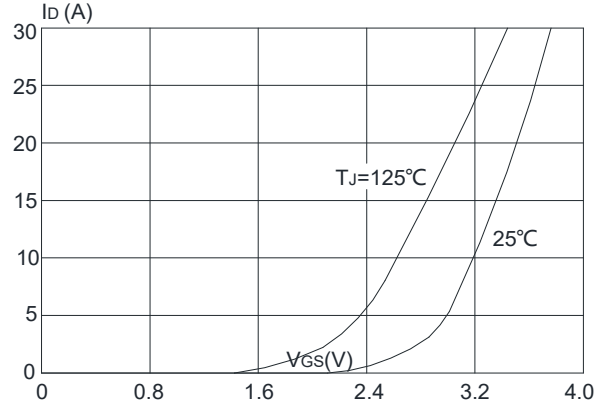

Figure 2: Typical Transfer Characteristics

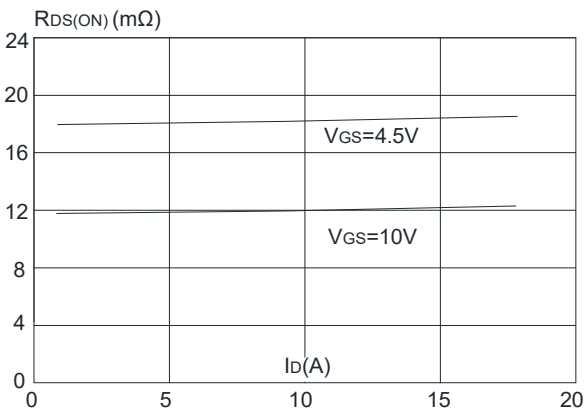

Figure 3: On-resistance vs. Drain Current

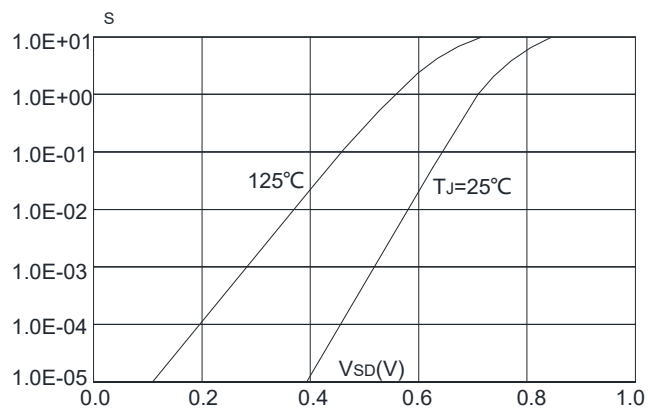

Figure 4: Body Diode Characteristics

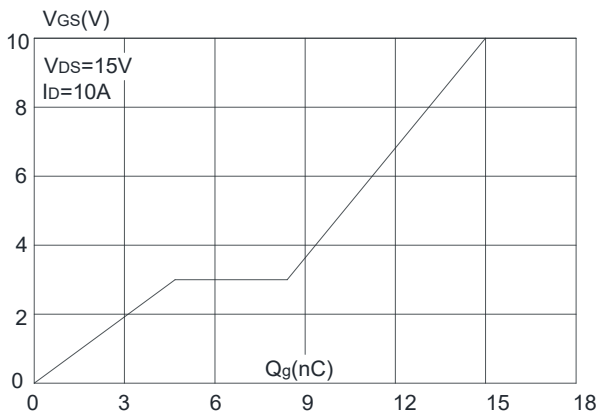

Figure 5: Gate Charge Characteristics

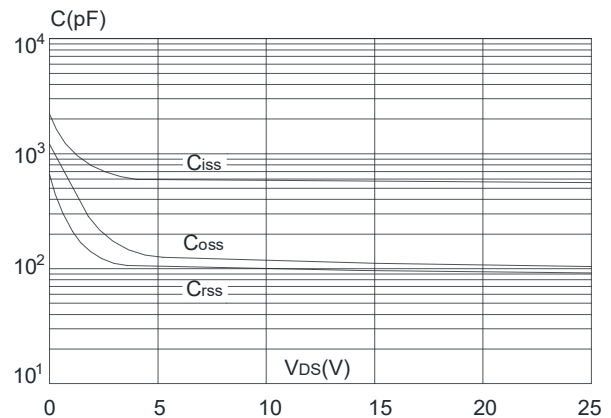

Figure 6: Capacitance Characteristics

TM30G03DF

N+P-Channel Enhancement Mode Mosfet

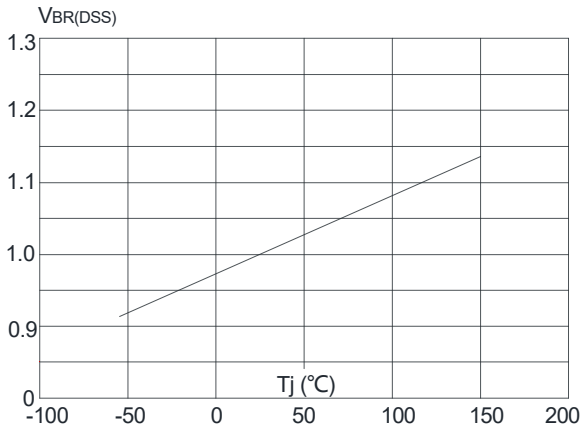

Figure 7: Normalized Breakdown Voltage vs. Junction Temperature

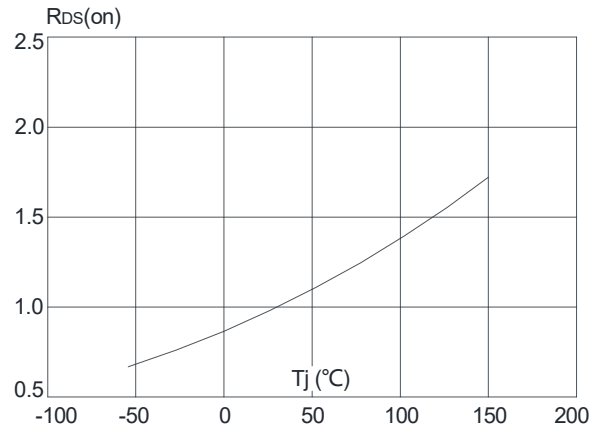

Figure 8: Normalized on Resistance vs. Junction Temperature

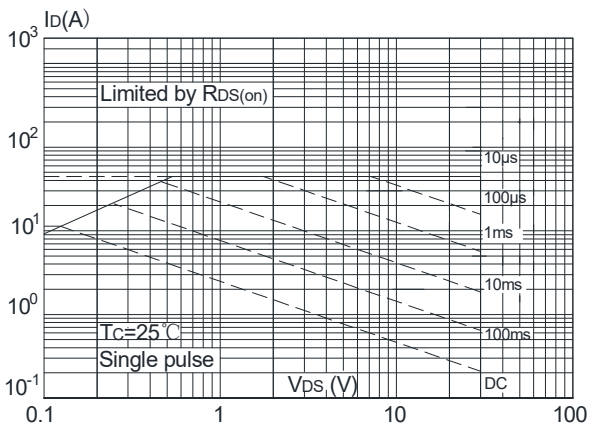

Figure 9: Maximum Safe Operating Area

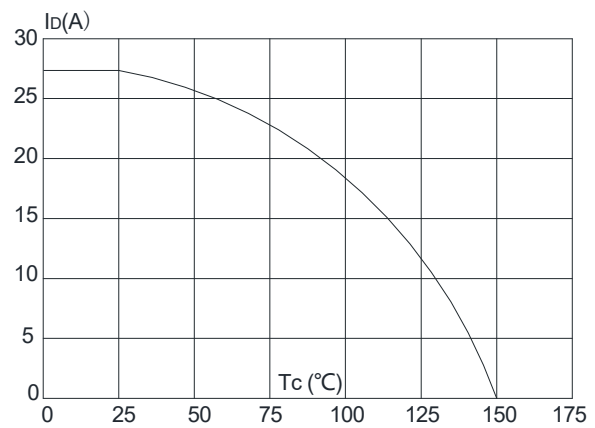

Figure 10: Maximum Continuous Drain Current vs. Case Temperature

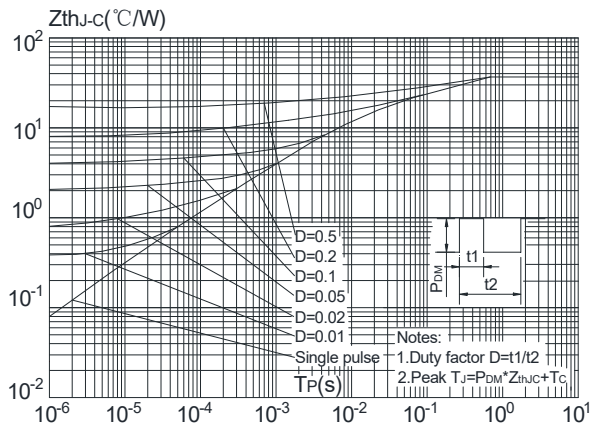

Figure.11: Maximum Effective Transient Thermal Impedance, Junction-to-Case

TM30G03DF

N+P-Channel Enhancement Mode Mosfet

P-Channel Electrical Characteristics: ($T_C=25^{\circ}\text{C}$ unless otherwise noted)

Symbol	Parameter	Conditions	Min	Typ	Max	Units
Off Characteristics						
BV_{DSS}	Drain-Source Breakdown Voltage	$V_{GS}=0V, I_D=250 \mu A$	-30	---	---	V
I_{DSS}	Zero Gate Voltage Drain Current	$V_{GS}=0V, V_{DS}=-30V$	---	---	-1	μA
I_{GSS}	Gate-Source Leakage Current	$V_{GS}=\pm 20V, V_{DS}=0A$	---	---	± 100	nA
On Characteristics³						
$V_{GS(th)}$	GATE-Source Threshold Voltage	$V_{GS}=V_{DS}, I_D=250 \mu A$	-1	-1.5	-2.5	V
$R_{DS(on)}$	Drain-Source On Resistance ^{note3}	$V_{GS}=-10V, I_D=-10A$	---	19	25	m Ω
		$V_{GS}=-4.5V, I_D=-5A$	---	25	38	
Dynamic Characteristics						
C_{iss}	Input Capacitance	$V_{DS}=-15V, V_{GS}=0V, f=1MHz$	---	1150	---	μF
C_{oss}	Output Capacitance		---	150	---	
C_{rss}	Reverse Transfer Capacitance		---	135	---	
Switching Characteristics⁴						
$t_{d(on)}$	Turn-On Delay Time	$V_{DD}=-15V, I_D=-1A,$ $V_{GS}=-10V, R_{GEN}=6 \Omega$ $R_D=15 \Omega$	---	12	---	ns
t_r	Rise Time		---	13	---	ns
$t_{d(off)}$	Turn-Off Delay Time		---	195	---	ns
t_f	Fall Time		---	95	---	ns
Q_g	Total Gate Charge	$V_{GS}=-10V, V_{DS}=-15V, I_D=-8A$	---	50	---	nC
Q_{gs}	Gate-Source Charge		---	9.5	---	nC
Q_{gd}	Gate-Drain "Miller" Charge		---	8.3	---	nC
Drain-Source Diode Characteristics						
I_S	Continuous Drain to Source Diode	---	---	---	-30	A
I_{SM}	Pulsed Drain to Source Diode	---	---	---	-44	---
V_{SD}	Source-Drain Diode Forward Voltage	$V_{GS}=0V, I_S=-11A$	---	-0.8	-1.2	V
T_{rr}	Reverse Recovery Time	$T_J=25^{\circ}\text{C},$	---	37	---	ns
Q_{rr}	Reverse Recovery Charge	$I_F=-2A, di/dt=-100A/\mu s$	---	36	---	nC



Typical Performance Characteristics-P

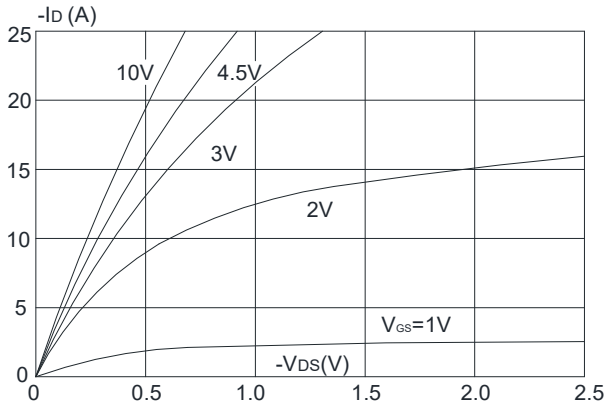

Figure 1: Output Characteristics

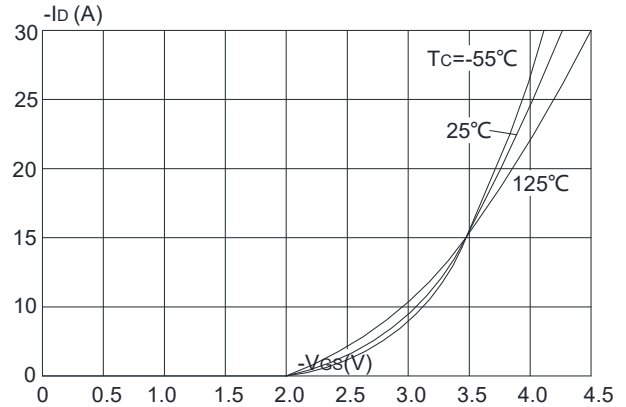

Figure 2: Typical Transfer Characteristics

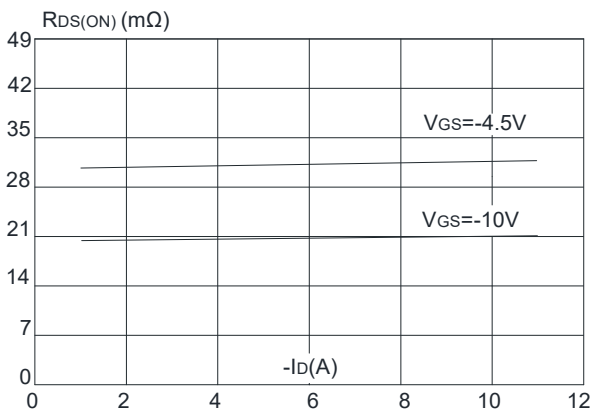

Figure 3: On-resistance vs. Drain Current

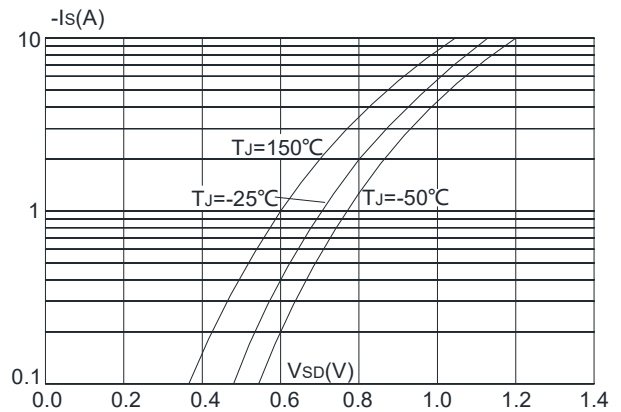

Figure 4: Body Diode Characteristics

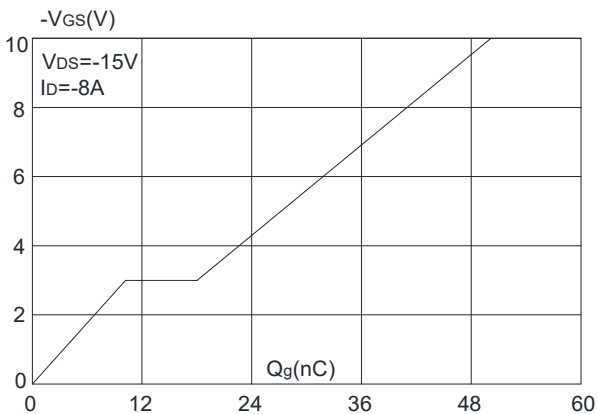

Figure 5: Gate Charge Characteristics

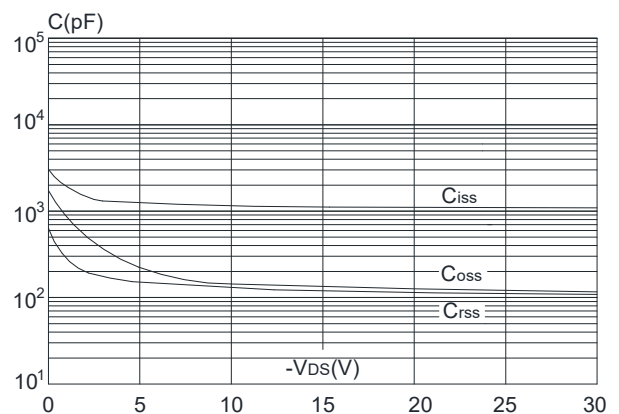

Figure 6: Capacitance Characteristics

TM30G03DF

N+P-Channel Enhancement Mode Mosfet

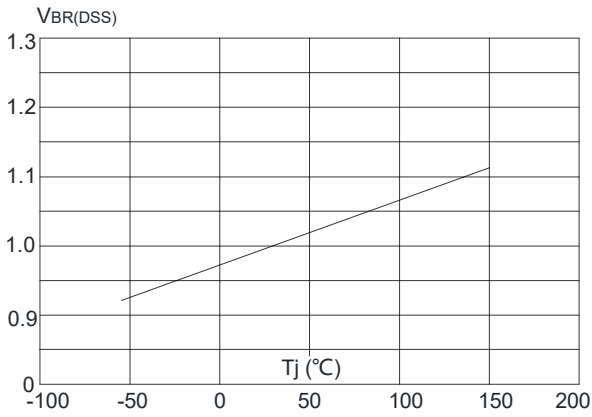

Figure 7: Normalized Breakdown Voltage vs. Junction Temperature

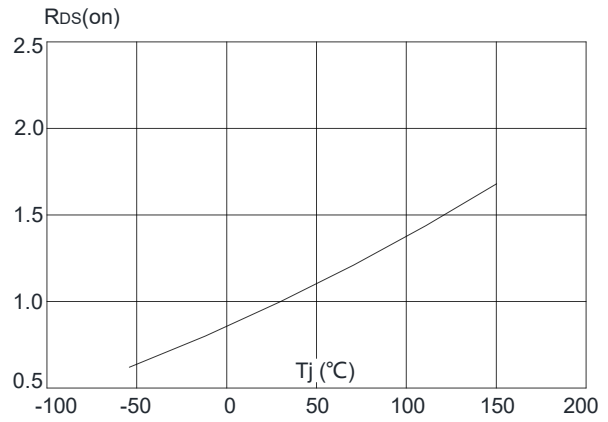

Figure 8: Normalized on Resistance vs. Junction Temperature

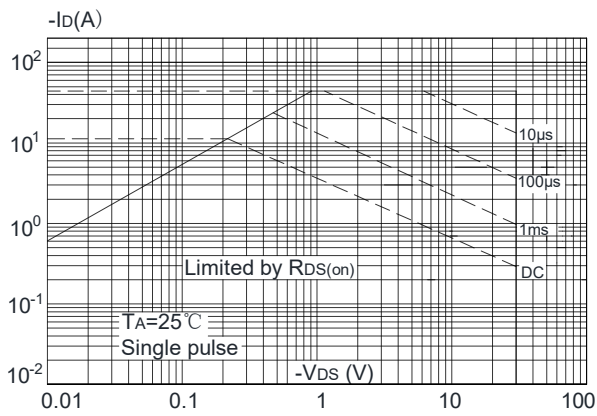

Figure 9: Maximum Safe Operating Area

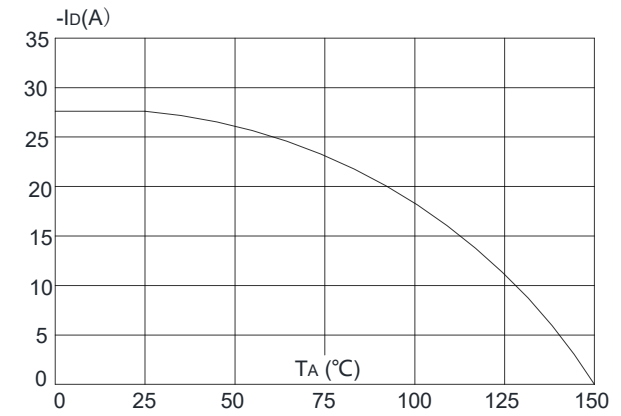

Figure 10: Maximum Continuous Drain Current vs. Ambient Temperature

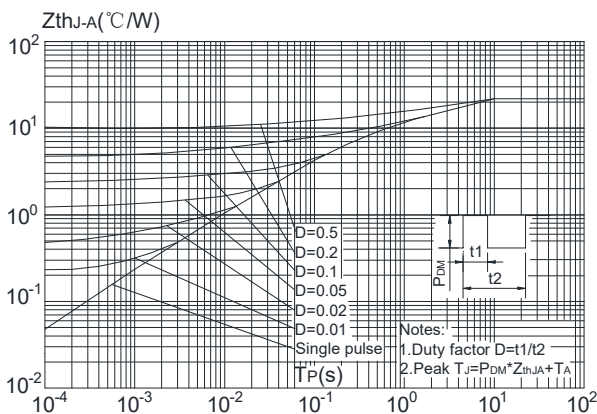
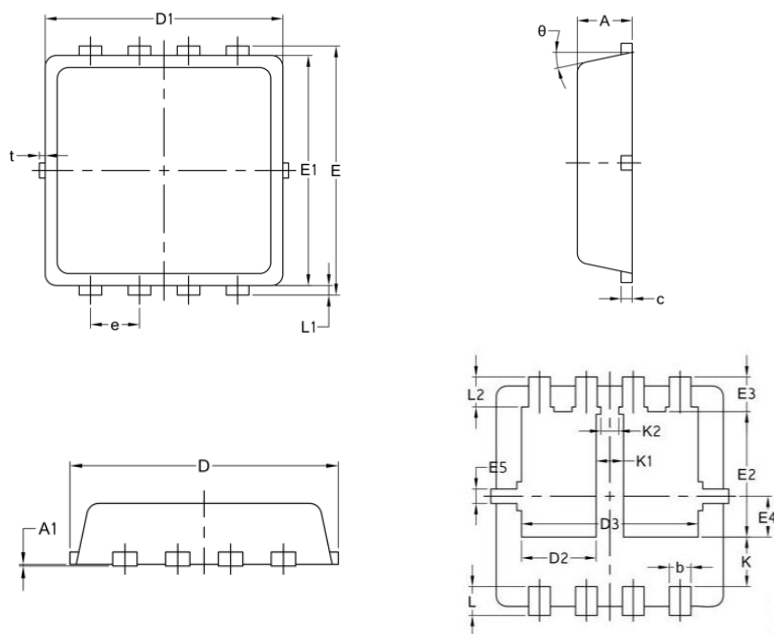

Figure.11: Maximum Effective Transient Thermal Impedance, Junction-to-Ambient

Package Mechanical Data:DFN3x3-8L



Symbol	Common		
	Mm		
	Min	Nom	Max
A	0.70	0.75	0.85
A1	/	/	0.05
b	0.25	0.30	0.39
c	0.14	0.152	0.20
D	3.20	3.30	3.45
D1	3.05	3.15	3.25
D2	0.84	1.04	1.24
D3	2.30	2.45	2.60
E	3.20	3.30	3.40
E1	2.95	3.05	3.15
E2	1.60	1.74	1.90
E3	0.28	0.48	0.65
E4	0.37	0.57	0.77
E5	0.10	0.20	0.30
e	0.60	0.65	0.70
K	0.50	0.69	0.80
K1	0.30	0.38	0.53
K2	0.15	0.25	0.35
L	0.30	0.40	0.50
L1	0.06	0.125	0.20
L2	0.27	0.42	0.57
t	0	0.075	0.13
Φ	10°	12°	14°

X-ON Electronics

Largest Supplier of Electrical and Electronic Components

Click to view similar products for [MOSFET](#) category:

Click to view products by [Tritech-MOS](#) manufacturer:

Other Similar products are found below :

[IRFD120](#) [JANTX2N5237](#) [BUK455-60A/B](#) [MIC4420CM-TR](#) [VN1206L](#) [NDP4060](#) [SI4482DY](#) [IPS70R2K0CEAKMA1](#) [SQD23N06-31L-GE3](#)
[TK16J60W,S1VQ\(O](#) [2SK2614\(TE16L1,Q\)](#) [DMN1017UCP3-7](#) [DMN1053UCP4-7](#) [SQJ469EP-T1-GE3](#) [NTE2384](#) [DMC2700UDMQ-7](#)
[DMN2080UCB4-7](#) [DMN61D9UWQ-13](#) [US6M2GTR](#) [DMN31D5UDJ-7](#) [DMP22D4UFO-7B](#) [DMN1006UCA6-7](#) [DMN16M9UCA6-7](#)
[STF5N65M6](#) [IRF40H233XTMA1](#) [STU5N65M6](#) [DMN6022SSD-13](#) [DMN13M9UCA6-7](#) [DMTH10H4M6SPS-13](#) [DMN2990UFB-7B](#)
[IPB80P04P405ATMA2](#) [2N7002W-G](#) [MCAC30N06Y-TP](#) [MCQ7328-TP](#) [BXP7N65D](#) [BXP4N65F](#) [AOL1454G](#) [WMJ80N60C4](#) [BXP2N20L](#)
[BXP2N65D](#) [BXT1150N10J](#) [BXT1700P06M](#) [TSM60NB380CP](#) [ROG](#) [RQ7L055BGTCR](#) [DMNH15H110SK3-13](#) [SLF10N65ABV2](#)
[BSO203SP](#) [BSO211P](#) [IPA60R230P6](#) [IPA60R460CE](#)