



TM30N06DF

N-Channel Enhancement Mosfet

<p>General Description</p> <ul style="list-style-type: none"> • Low $R_{DS(ON)}$ • RoHS and Halogen-Free Compliant <p>Applications</p> <ul style="list-style-type: none"> • Load switch • PWM 	<p>General Features</p> <p>$V_{DS} = 60V$ $I_D = 30A$</p> <p>$R_{DS(ON)} = 28m\Omega$ (typ.) @ $V_{GS} = 10V$</p> <p>100% UIS Tested 100% R_g Tested</p> 
--	---

DF:DFN3x3_8L

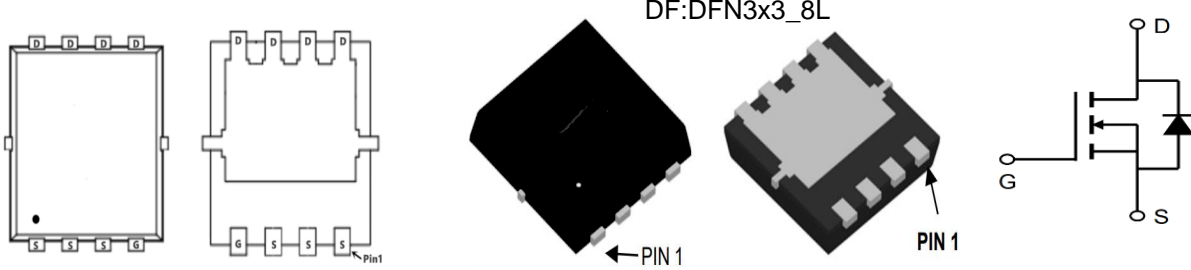

Marking 30N06

Absolute Maximum Ratings @ $T_j = 25^\circ C$ (unless otherwise specified)

Symbol	Parameter	Max.	Units
V_{DSS}	Drain-Source Voltage	60	V
V_{GSS}	Gate-Source Voltage	± 20	V
$I_D @ T_C = 25^\circ C$	Continuous Drain Current, $V_{GS} @ 10V^1$	30	A
$I_D @ T_C = 100^\circ C$	Continuous Drain Current, $V_{GS} @ 10V^1$	16	A
IDM	Pulsed Drain Current	74	A
IAS	Avalanche Current	13	A
EAS	Single Pulsed Avalanche Energy	22	mJ
$P_D @ T_C = 25^\circ C$	Power Dissipation	31.3	W
T_J, T_{STG}	Operating and Storage Temperature Range	-55 to +175	$^\circ C$
$R_{\theta JA}$	Thermal Resistance Junction-Ambient ¹	62.5	$^\circ C/W$
$R_{\theta JC}$	Thermal Resistance Junction-Case ¹	4	$^\circ C/W$

TM30N06DF

N-Channel Enhancement Mosfet

Electrical Characteristics (T_J=25°C, unless otherwise noted)

Symbol	Parameter	Conditions	Min.	Typ.	Max.	Unit
BVDSS	Drain-Source Breakdown Voltage	V _{GS} =0V, I _D =250uA	60	65	---	V
ΔBVDSS/ΔT _J	BVDSS Temperature Coefficient	Reference to 25°C, I _D =1mA	---	0.044	---	V/°C
RDS(ON)	Static Drain-Source On-Resistance ²	V _{GS} =10V, I _D =15A	---	28	36	mΩ
		V _{GS} =4.5V, I _D =7A	---	38	45	mΩ
VGS(th)	Gate Threshold Voltage	V _{GS} =V _{DS} , I _D =250uA	1.2	1.6	2.5	V
ΔVGS(th)	VGS(th) Temperature Coefficient		---	-4.8	---	mV/°C
IDSS	Drain-Source Leakage Current	V _{DS} =48V, V _{GS} =0V, T _J =25°C	---	---	1	uA
		V _{DS} =48V, V _{GS} =0V, T _J =55°C	---	---	5	
IGSS	Gate-Source Leakage Current	V _{GS} =±20V, V _{DS} =0V	---	---	±100	nA
gfs	Forward Transconductance	V _{DS} =5V, I _D =15A	---	25.3	---	S
R _g	Gate Resistance	V _{DS} =0V, V _{GS} =0V, f=1MHz	---	2.5	---	Ω
Q _g	Total Gate Charge (10V)	V _{DS} =48V, V _{GS} =10V, I _D =15A	---	19	---	nC
Q _{gs}	Gate-Source Charge		---	2.5	---	
Q _{gd}	Gate-Drain Charge		---	5	---	
Td(on)	Turn-On Delay Time	V _{DD} =30V, V _{GS} =10V, R _G =3.3Ω, I _D =15A	---	2.8	---	ns
T _r	Rise Time		---	16.6	---	
Td(off)	Turn-Off Delay Time		---	21.2	---	
T _f	Fall Time		---	5.6	---	
C _{iss}	Input Capacitance	V _{DS} =15V, V _{GS} =0V, f=1MHz	---	1027	---	pF
C _{oss}	Output Capacitance		---	65	---	
C _{rss}	Reverse Transfer Capacitance		---	46	---	
I _S	Continuous Source Current ^{1,6}	V _G =V _D =0V, Force Current	---	---	20	A
ISM	Pulsed Source Current ^{2,6}		---	---	40	A
VSD	Diode Forward Voltage ²	V _{GS} =0V, I _S =1A, T _J =25°C	---	---	1.2	V
t _{rr}	Reverse Recovery Time	IF=15A, dI/dt=100A/μs, T _J =25°C	---	12.2	---	nS
Q _{rr}	Reverse Recovery Charge		---	7.3	---	nC

Note :

1. The data tested by surface mounted on a 1 inch² FR-4 board with 2OZ copper.
2. The data tested by pulsed, pulse width. The EAS data shows Max. rating.
3. The test cond ≅ 300us duty cycle ≅ 2%, duty cycle ition is T_J=25°C, V_{DD}=48V, V_G=10V, R_G=25Ω, L=0.1mH, I_{AS}=13A
4. The power dissipation is limited by 175°C junction temperature
5. The data is theoretically the same as ID and IDM, in real applications, should be limited by total power dissipation.



TM30N06DF

N-Channel Enhancement Mosfet

Typical Characteristics

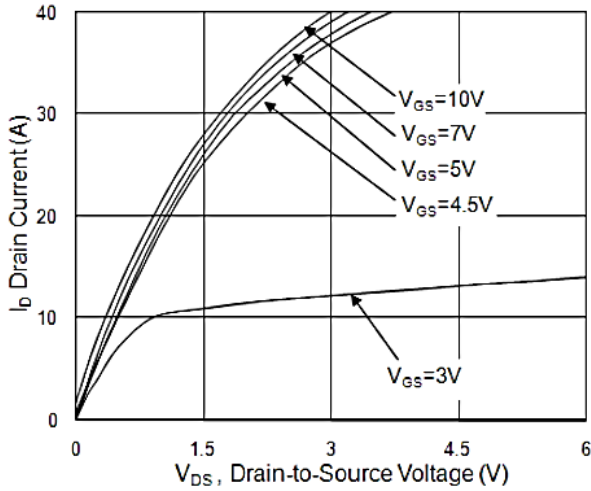

Fig.1 Typical Output Characteristics

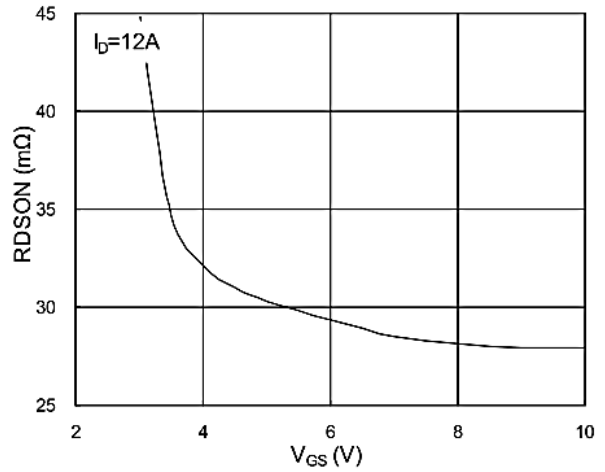

Fig.2 On-Resistance vs. Gate-Source

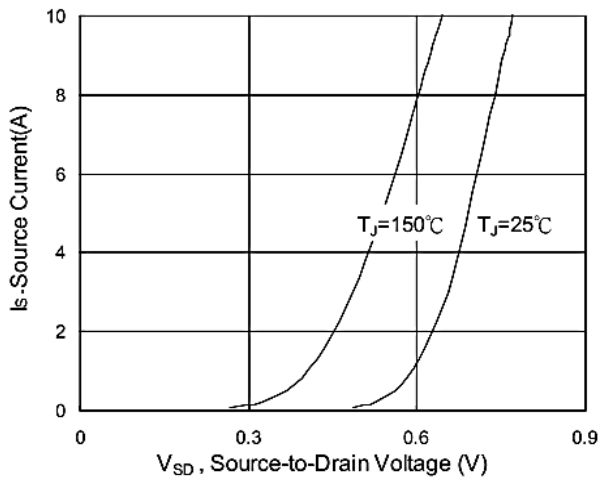

Fig.3 Forward Characteristics Of Reverse

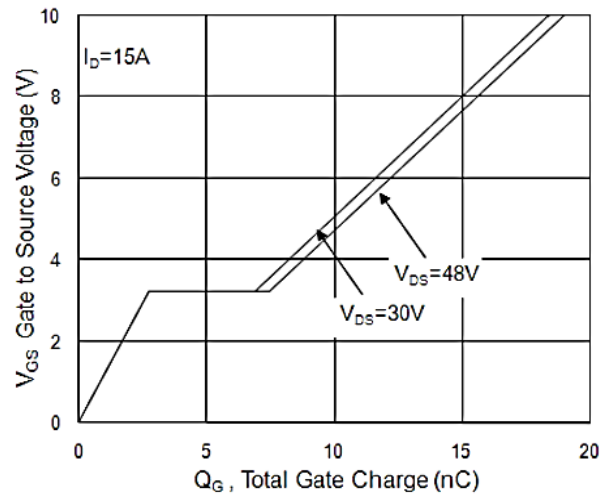

Fig.4 Gate-Charge Characteristics

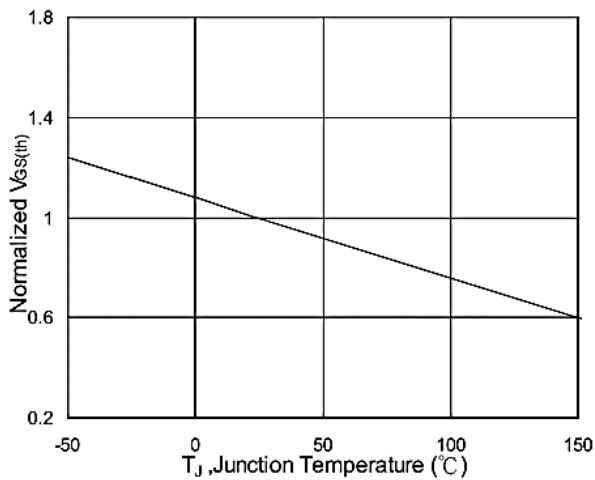

Fig.5 Normalized $V_{GS(th)}$ vs. T_J

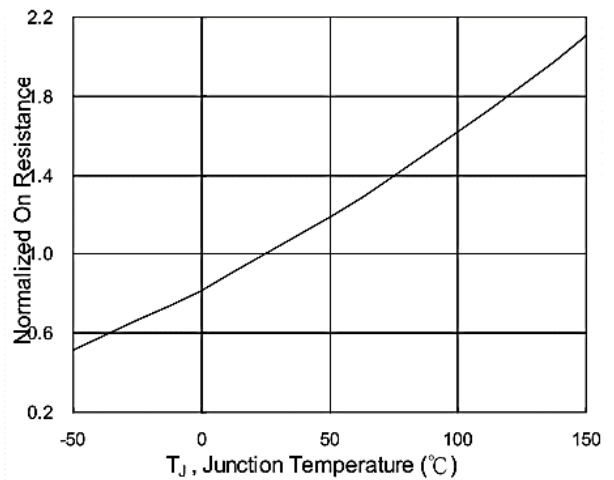

Fig.6 Normalized $R_{DS(on)}$ vs. T_J



TM30N06DF

N-Channel Enhancement Mosfet

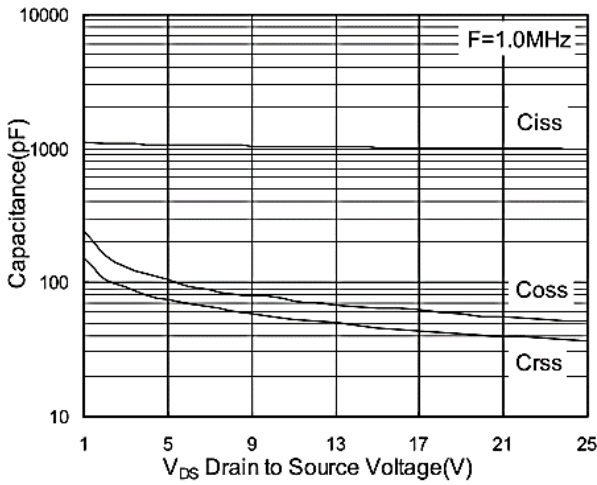

Fig.7 Capacitance

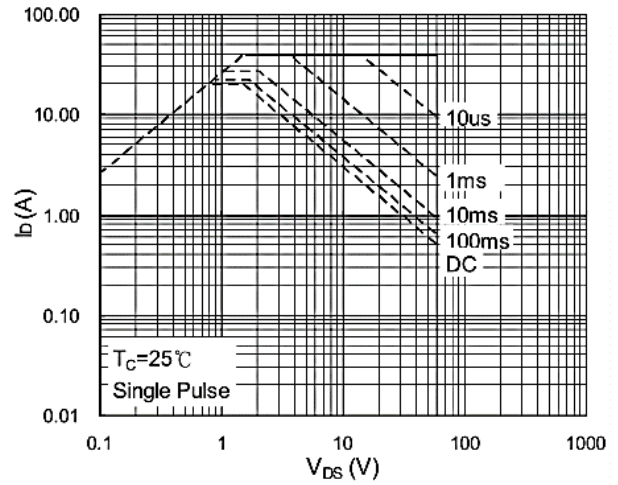

Fig.8 Safe Operating Area

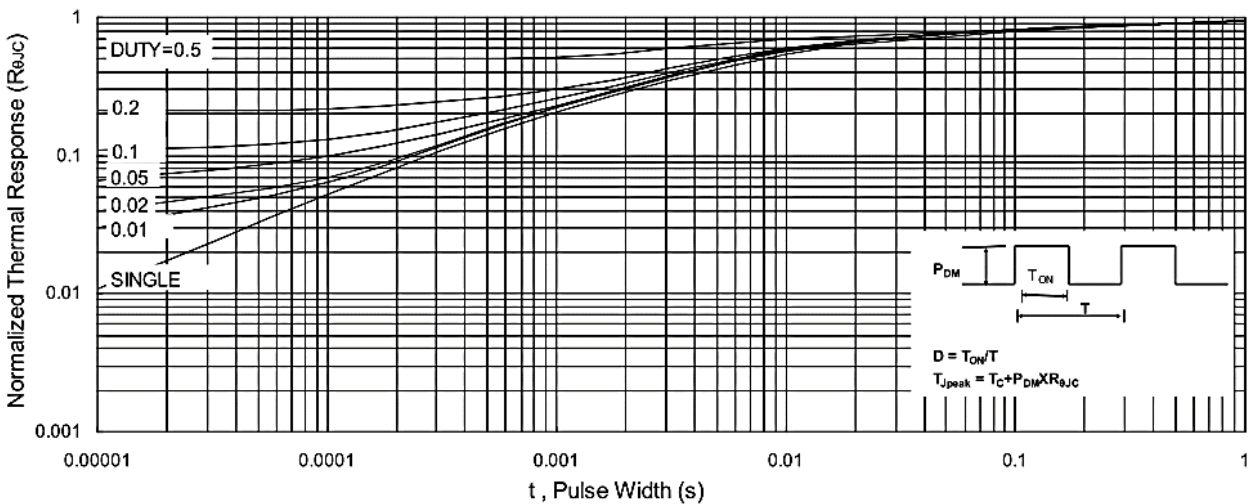

Fig.9 Normalized Maximum Transient Thermal Impedance

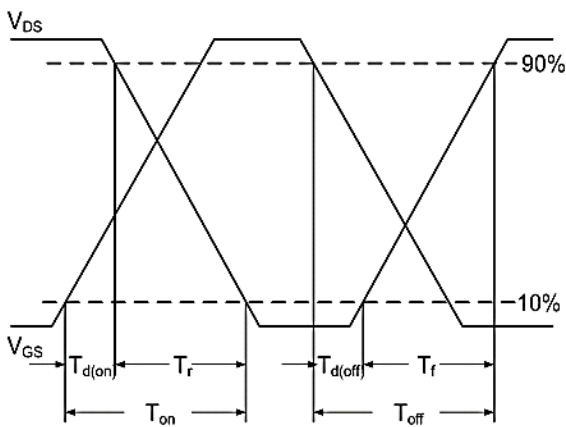

Fig.10 Switching Time Waveform

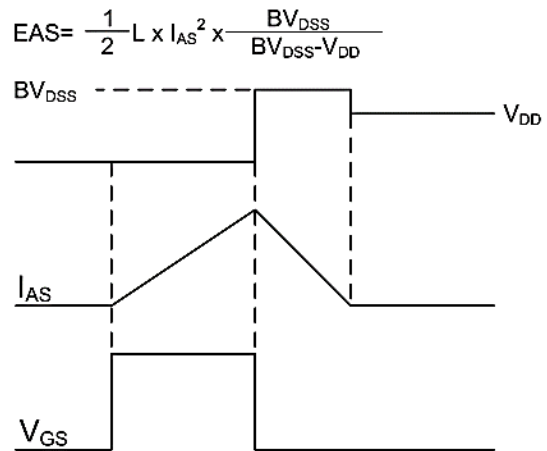
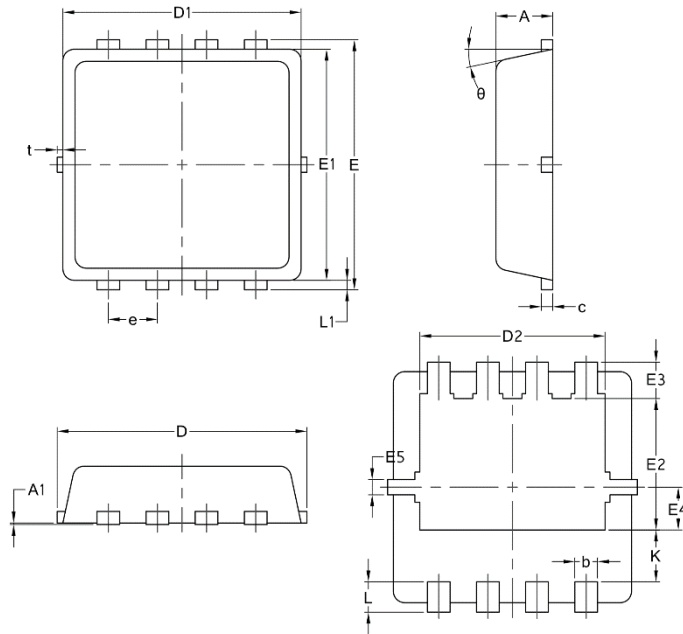

Fig.11 Unclamped Inductive Switching Waveform

Package Mechanical Data:DFN3x3–8L



Symbol	Common		
	mm		
	Mim	Nom	Max
A	0.70	0.75	0.85
A1	/	/	0.05
b	0.20	0.30	0.40
c	0.10	0.152	0.25
D	3.15	3.30	3.45
D1	3.00	3.15	3.25
D2	2.29	2.45	2.65
E	3.15	3.30	3.45
E1	2.90	3.05	3.20
E2	1.54	1.74	1.94
E3	0.28	0.48	0.65
E4	0.37	0.57	0.77
E5	0.10	0.20	0.30
e	0.60	0.65	0.70
K	0.59	0.69	0.89
L	0.30	0.40	0.50
L1	0.06	0.125	0.20
t	0	0.075	0.13
Φ	10	12	14

X-ON Electronics

Largest Supplier of Electrical and Electronic Components

Click to view similar products for [MOSFET](#) category:

Click to view products by [Tritech-MOS](#) manufacturer:

Other Similar products are found below :

[IRFD120](#) [JANTX2N5237](#) [BUK455-60A/B](#) [MIC4420CM-TR](#) [VN1206L](#) [NDP4060](#) [SI4482DY](#) [IPS70R2K0CEAKMA1](#) [SQD23N06-31L-GE3](#)
[TK16J60W,S1VQ\(O](#) [2SK2614\(TE16L1,Q\)](#) [DMN1017UCP3-7](#) [DMN1053UCP4-7](#) [SQJ469EP-T1-GE3](#) [NTE2384](#) [DMC2700UDMQ-7](#)
[DMN2080UCB4-7](#) [DMN61D9UWQ-13](#) [US6M2GTR](#) [DMN31D5UDJ-7](#) [DMP22D4UFO-7B](#) [DMN1006UCA6-7](#) [DMN16M9UCA6-7](#)
[STF5N65M6](#) [IRF40H233XTMA1](#) [STU5N65M6](#) [DMN6022SSD-13](#) [DMN13M9UCA6-7](#) [DMTH10H4M6SPS-13](#) [DMN2990UFB-7B](#)
[IPB80P04P405ATMA2](#) [2N7002W-G](#) [MCAC30N06Y-TP](#) [MCQ7328-TP](#) [BXP7N65D](#) [BXP4N65F](#) [AOL1454G](#) [WMJ80N60C4](#) [BXP2N20L](#)
[BXP2N65D](#) [BXT1150N10J](#) [BXT1700P06M](#) [TSM60NB380CP](#) [ROG](#) [RQ7L055BGTCR](#) [DMNH15H110SK3-13](#) [SLF10N65ABV2](#)
[BSO203SP](#) [BSO211P](#) [IPA60R230P6](#) [IPA60R460CE](#)