

**TM4886**

**N+N-Channel Enhancement Mode Mosfet**

**General Description**

- Low  $R_{DS(ON)}$
- RoHS and Halogen-Free Compliant

**Applications**

- Load switch
- PWM

**Product Summary**

$V_{DS} = 100V$   $I_D = 8.0A$

$R_{DS(ON)} = 88\ m\Omega$  (typ.) @  $V_{GS} = 10V$

100% UIS Tested

100%  $R_g$  Tested

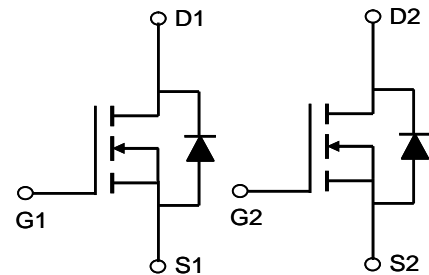
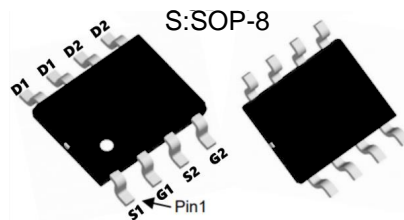
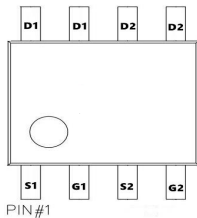

Marking: 08H10 OR 4886

**Absolute Maximum Ratings** ( $T_A = 25^\circ C$  unless otherwise noted)

Symbol	Parameter	Rating	Units
$V_{DS}$	Drain-Source Voltage	100	V
$V_{GS}$	Gate-Source Voltage	$\pm 20$	V
$I_D @ T_C = 25^\circ C$	Continuous Drain Current, $V_{GS} @ 10V^1$	8	A
$I_D @ T_C = 100^\circ C$	Continuous Drain Current, $V_{GS} @ 10V^1$	5	A
$I_{DM}$	Pulsed Drain Current <sup>2</sup>	15	A
EAS	Single Pulse Avalanche Energy <sup>3</sup>	6.1	mJ
$P_D @ T_A = 25^\circ C$	Total Power Dissipation <sup>3</sup>	5	W
$T_{STG}$	Storage Temperature Range	-55 to 150	$^\circ C$
$T_J$	Operating Junction Temperature Range	-55 to 150	$^\circ C$

**Thermal Data**

Symbol	Parameter	Typ.	Max.	Unit
$R_{\theta JA}$	Thermal Resistance Junction-ambient <sup>1</sup>	---	125	$^\circ C/W$
$R_{\theta JC}$	Thermal Resistance Junction-Case <sup>1</sup>	---	3.6	$^\circ C/W$

**Electrical Characteristics** ( $T_J=25^\circ\text{C}$  unless otherwise specified)

Symbol	Parameter	Test Condition	Min.	Typ.	Max.	Units
<b>Off Characteristic</b>						
$V_{(BR)DSS}$	Drain-Source Breakdown Voltage	$V_{GS}=0V, I_D=250\mu A$	100	-	-	V
$I_{DSS}$	Zero Gate Voltage Drain Current	$V_{DS}=100V, V_{GS}=0V,$	-	-	1.0	$\mu A$
$I_{GSS}$	Gate to Body Leakage Current	$V_{DS}=0V, V_{GS}=\pm 20V$	-	-	$\pm 100$	nA
<b>On Characteristics</b>						
$V_{GS(th)}$	Gate Threshold Voltage	$V_{DS}=V_{GS}, I_D=250\mu A$	1.0	1.5	2.5	V
$R_{DS(on)}$	Static Drain-Source on-Resistance <small>note3</small>	$V_{GS}=10V, I_D=3A$	-	88	105	m $\Omega$
		$V_{GS}=4.5V, I_D=2A$	-	100	128	m $\Omega$
<b>Dynamic Characteristics</b>						
$C_{iss}$	Input Capacitance	$V_{DS}=25V, V_{GS}=0V,$ $f=1.0MHz$	-	610	-	pF
$C_{oss}$	Output Capacitance		-	40	-	pF
$C_{rss}$	Reverse Transfer Capacitance		-	25	-	pF
$Q_g$	Total Gate Charge	$V_{DS}=50V, I_D=2A,$ $V_{GS}=10V$	-	12	-	nC
$Q_{gs}$	Gate-Source Charge		-	2.2	-	nC
$Q_{gd}$	Gate-Drain("Miller") Charge		-	2.5	-	nC
<b>Switching Characteristics</b>						
$t_{d(on)}$	Turn-on Delay Time	$V_{DS}=50V, I_D=3A,$ $R_G=1.8\Omega, V_{GS}=10V$	-	7	-	ns
$t_r$	Turn-on Rise Time		-	5	-	ns
$t_{d(off)}$	Turn-off Delay Time		-	16	-	ns
$t_f$	Turn-off Fall Time		-	6	-	ns
<b>Drain-Source Diode Characteristics and Maximum Ratings</b>						
$I_S$	Maximum Continuous Drain to Source Diode Forward Current		-	-	3	A
$I_{SM}$	Maximum Pulsed Drain to Source Diode Forward Current		-	-	8	A
$V_{SD}$	Drain to Source Diode Forward Voltage	$V_{GS}=0V, I_S=3A$	-	-	1.2	V
$t_{rr}$	Body Diode Reverse Recovery Time	$I_F=3A, di/dt=100A/\mu s$	-	21	-	ns
$Q_{rr}$	Body Diode Reverse Recovery Charge		-	21	-	nC

Notes: 1. Repetitive Rating: Pulse Width Limited by Maximum Junction Temperature

2. EAS condition :  $T_J=25^\circ\text{C}, V_{DD}=50V, V_G=10V, L=0.5mH, R_g=25\Omega, I_{AS}=4A$

3. Pulse Test: Pulse Width  $\leq 300\mu s$ , Duty Cycle  $\leq 0.5\%$

## Typical Performance Characteristics

**Figure 1: Output Characteristics**

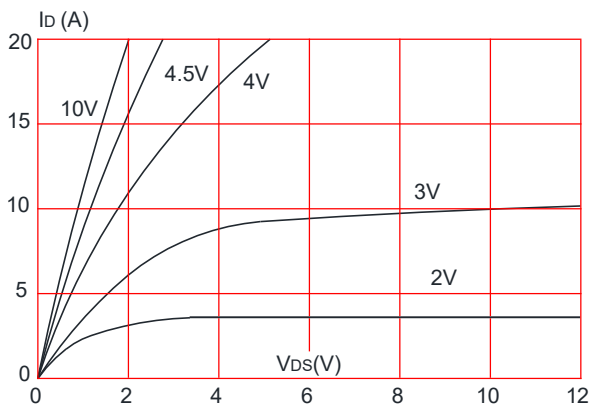

**Figure 2: Typical Transfer Characteristics**

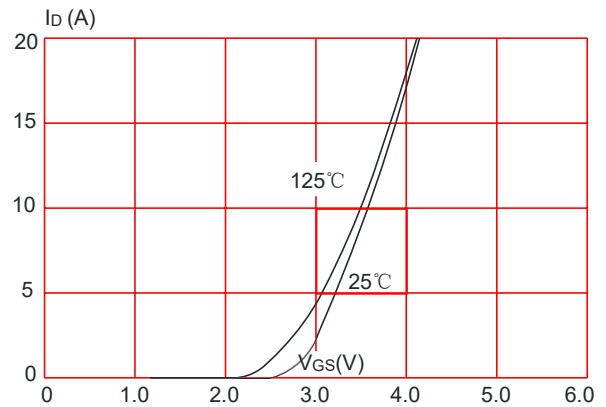

**Figure 3: On-resistance vs. Drain Current**

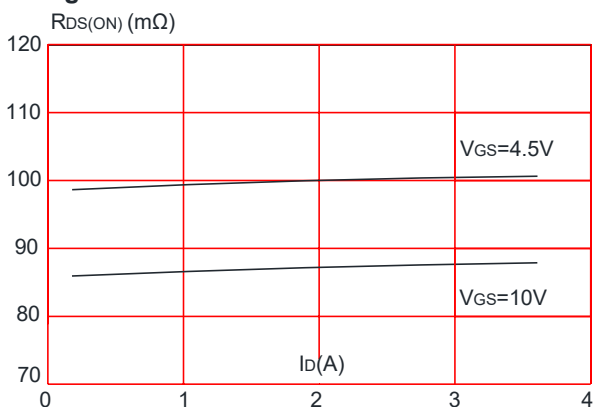

**Figure 4: Body Diode Characteristics**

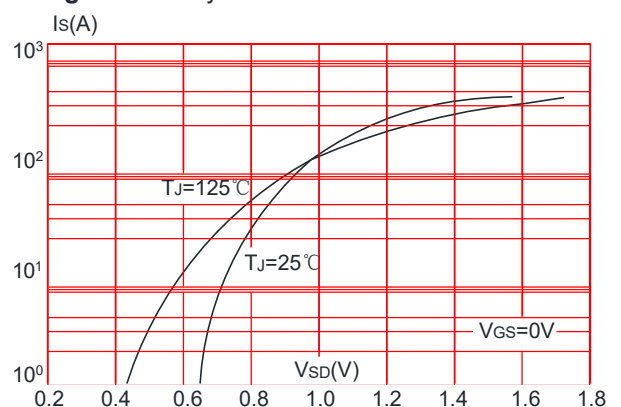

**Figure 5: Gate Charge Characteristics**

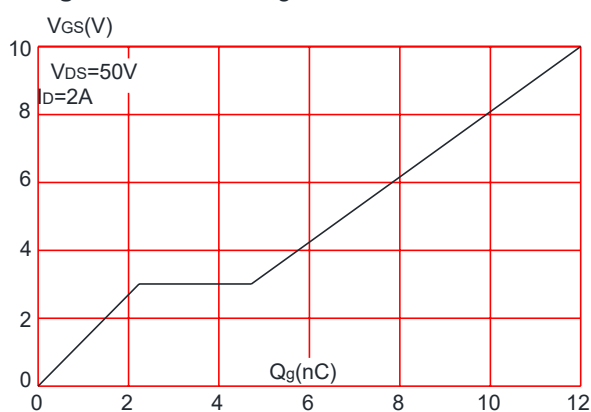

**Figure 6: Capacitance Characteristics**

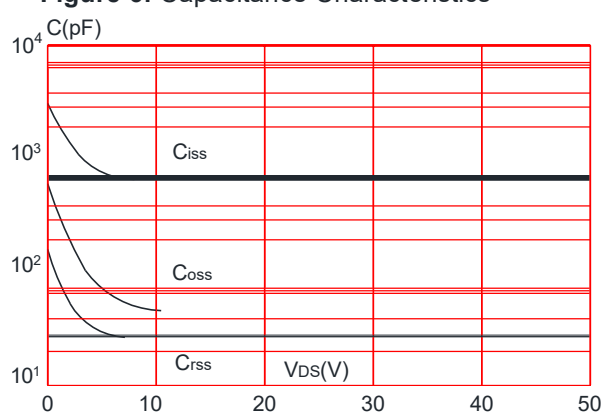

TM4886

N+N-Channel Enhancement Mode Mosfet

Figure 7: Normalized Breakdown Voltage vs. Junction Temperature

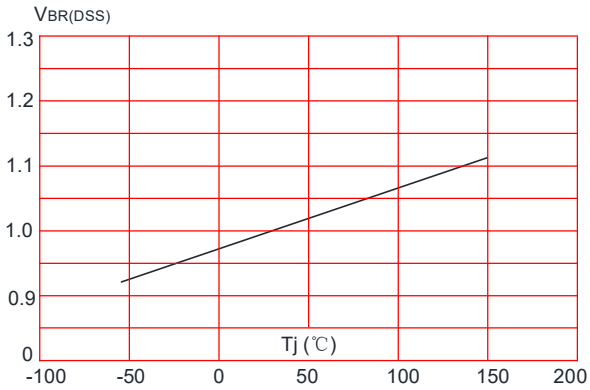

Figure 8: Normalized on Resistance vs. Junction Temperature

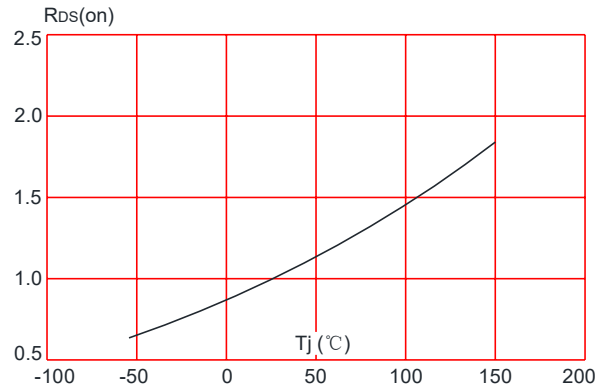

Figure 9: Maximum Safe Operating Area

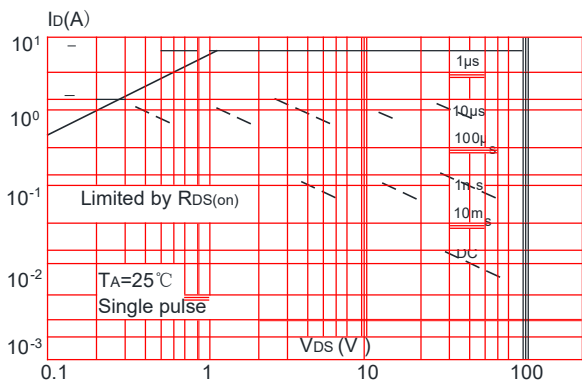

Figure 10: Maximum Continuous Drain Current vs. Ambient Temperature

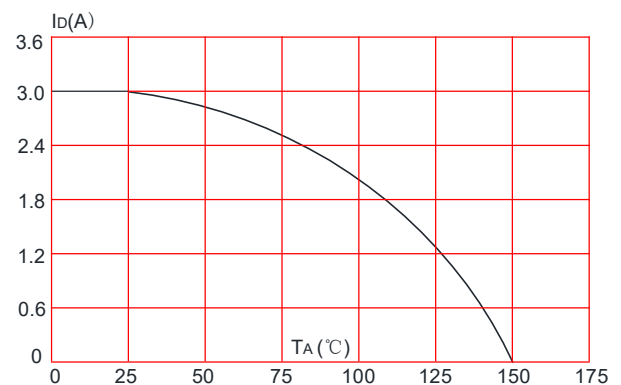
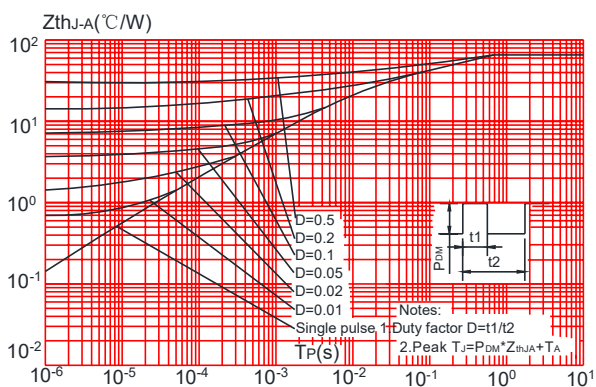
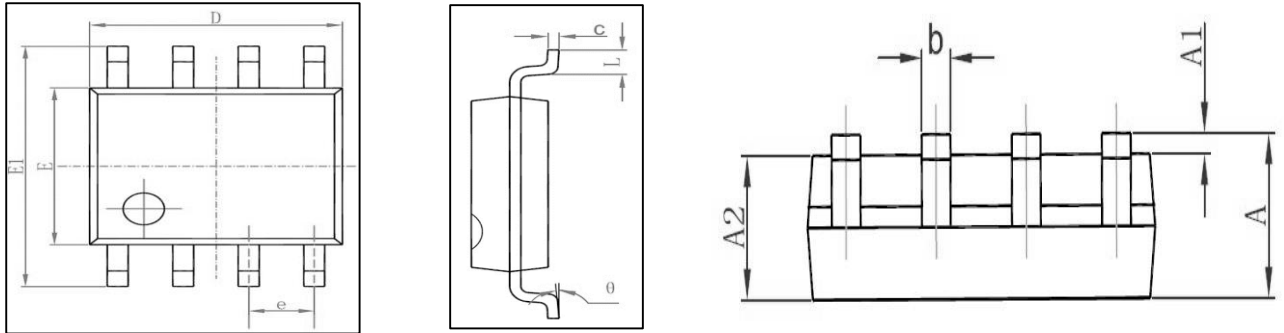

Figure.11: Maximum Effective Transient Thermal Impedance, Junction-to-Ambient



# Package Mechanical Data:SOP-8L



Symbol	Dimensions In Millimeters		Dimensions In Inches	
	Min	Max	Min	Max
A	1.350	1.750	0.053	0.069
A1	0.100	0.250	0.004	0.010
A2	1.350	1.550	0.053	0.061
b	0.330	0.510	0.013	0.020
c	0.170	0.250	0.006	0.010
D	4.700	5.100	0.185	0.200
E	3.800	4.000	0.150	0.157
E1	5.800	6.200	0.228	0.244
e	1.270 (BSC)		0.050 (BSC)	
L	0.400	1.270	0.016	0.050
θ	0°	8°	0°	8°

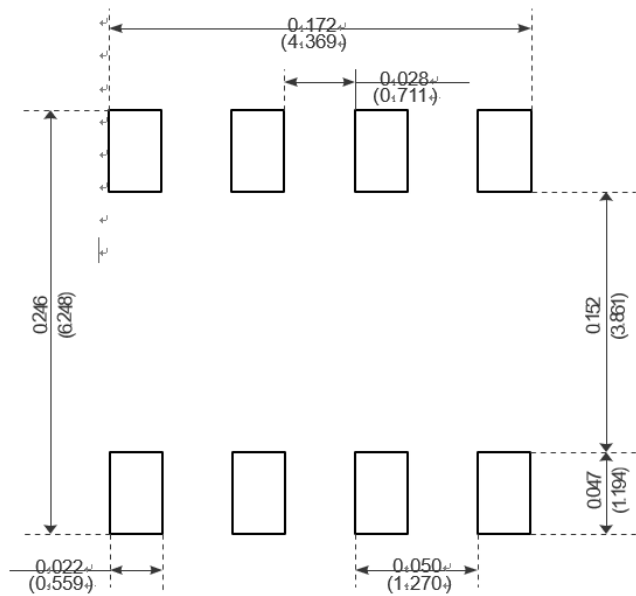

Recommended Minimum Pads

## X-ON Electronics

Largest Supplier of Electrical and Electronic Components

*Click to view similar products for [MOSFET](#) category:*

*Click to view products by [Tritech-MOS](#) manufacturer:*

Other Similar products are found below :

[IRFD120](#) [JANTX2N5237](#) [BUK455-60A/B](#) [MIC4420CM-TR](#) [VN1206L](#) [NDP4060](#) [SI4482DY](#) [IPS70R2K0CEAKMA1](#) [SQD23N06-31L-GE3](#)  
[TK16J60W,S1VQ\(O](#) [2SK2614\(TE16L1,Q\)](#) [DMN1017UCP3-7](#) [DMN1053UCP4-7](#) [SQJ469EP-T1-GE3](#) [NTE2384](#) [DMC2700UDMQ-7](#)  
[DMN2080UCB4-7](#) [DMN61D9UWQ-13](#) [US6M2GTR](#) [DMN31D5UDJ-7](#) [DMP22D4UFO-7B](#) [DMN1006UCA6-7](#) [DMN16M9UCA6-7](#)  
[STF5N65M6](#) [IRF40H233XTMA1](#) [STU5N65M6](#) [DMN6022SSD-13](#) [DMN13M9UCA6-7](#) [DMTH10H4M6SPS-13](#) [DMN2990UFB-7B](#)  
[IPB80P04P405ATMA2](#) [2N7002W-G](#) [MCAC30N06Y-TP](#) [MCQ7328-TP](#) [NTMC083NP10M5L](#) [BXP7N65D](#) [BXP4N65F](#) [AOL1454G](#)  
[WMJ80N60C4](#) [BXP2N20L](#) [BXP2N65D](#) [BXT1150N10J](#) [BXT1700P06M](#) [TSM60NB380CP](#) [ROG](#) [RQ7L055BGTGR](#) [DMNH15H110SK3-13](#)  
[SLF10N65ABV2](#) [BSO203SP](#) [BSO211P](#) [IPA60R230P6](#)