



## TM50N03DF

## N-Channel Enhancement Mosfet

## General Description

- Low  $R_{DS(ON)}$
- RoHS and Halogen-Free Compliant

## Applications

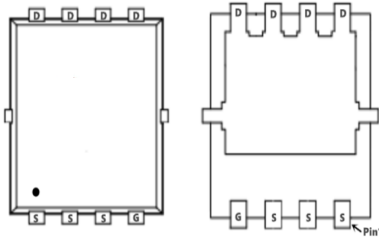
- Load switch
- PWM

## General Features

$V_{DS} = 30V \quad I_D = 50A$

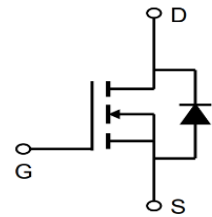
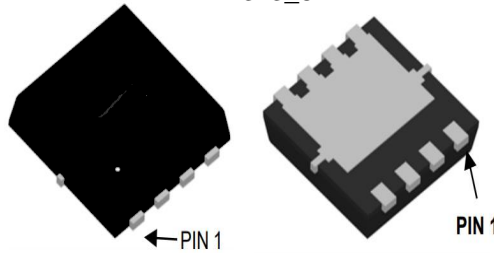
$R_{DS(ON)} = 7 m\Omega (Typ.) @ V_{GS} = 10V$

100% UIS Tested

100%  $R_g$  Tested

Marking:50N03D

DF:DFN3x3\_8L

Absolute Maximum Ratings ( $T_A = 25^\circ C$  Unless Otherwise Noted)

Symbol	Parameter	Rating	Units
$V_{DS}$	Drain-Source Voltage	30	V
$V_{GS}$	Gate-Source Voltage	$\pm 20$	V
$I_D @ T_C = 25^\circ C$	Continuous Drain Current, $V_{GS} @ 10V^1$	50	A
$I_D @ T_C = 100^\circ C$	Continuous Drain Current, $V_{GS} @ 10V^1$	30	A
$I_{DM}$	Pulsed Drain Current <sup>2</sup>	120	A
EAS	Single Pulse Avalanche Energy <sup>3</sup>	39	mJ
$I_{AS}$	Avalanche Current	50	A
$P_D @ T_C = 25^\circ C$	Total Power Dissipation <sup>4</sup>	18	W
$T_{STG}$	Storage Temperature Range	-55 to 150	$^\circ C$
$T_J$	Operating Junction Temperature Range	-55 to 150	$^\circ C$

## Thermal Data

Symbol	Parameter	Typ.	Max.	Unit
$R_{\theta JA}$	Thermal Resistance Junction-ambient <sup>1</sup>	---	75	$^\circ C/W$
$R_{\theta JC}$	Thermal Resistance Junction-Case <sup>1</sup>	---	4.32	$^\circ C/W$

**Electrical Characteristics (T<sub>J</sub>=25 °C, unless otherwise noted)**

Symbol	Parameter	Conditions	Min.	Typ.	Max.	Unit
BV <sub>DSS</sub>	Drain-Source Breakdown Voltage	V <sub>GS</sub> =0V, I <sub>D</sub> =250uA	30	---	---	V
ΔBV <sub>DSS</sub> /ΔT <sub>J</sub>	BVDSS Temperature Coefficient	Reference to 25°C, I <sub>D</sub> =1mA	---	0.027	---	V/°C
R <sub>DS(ON)</sub>	Static Drain-Source On-Resistance <sup>2</sup>	V <sub>GS</sub> =10V, I <sub>D</sub> =12A	---	7	8.5	mΩ
		V <sub>GS</sub> =4.5V, I <sub>D</sub> =10A	---	10	14	
V <sub>GS(th)</sub>	Gate Threshold Voltage	V <sub>GS</sub> =V <sub>DS</sub> , I <sub>D</sub> =250uA	1.0	1.5	2.5	V
ΔV <sub>GS(th)</sub>	V <sub>GS(th)</sub> Temperature Coefficient		---	-5.8	---	mV/°C
I <sub>DSS</sub>	Drain-Source Leakage Current	V <sub>DS</sub> =24V, V <sub>GS</sub> =0V, T <sub>J</sub> =25°C	---	---	1	uA
		V <sub>DS</sub> =24V, V <sub>GS</sub> =0V, T <sub>J</sub> =55°C	---	---	5	
I <sub>GSS</sub>	Gate-Source Leakage Current	V <sub>GS</sub> =±20V, V <sub>DS</sub> =0V	---	---	±100	nA
R <sub>g</sub>	Gate Resistance	V <sub>DS</sub> =0V, V <sub>GS</sub> =0V, f=1MHz	---	1.7	---	Ω
Q <sub>g</sub>	Total Gate Charge (4.5V)	V <sub>DS</sub> =20V, V <sub>GS</sub> =4.5V, I <sub>D</sub> =12A	---	12.8	---	nC
Q <sub>gs</sub>	Gate-Source Charge		---	3.3	---	
Q <sub>gd</sub>	Gate-Drain Charge		---	6.5	---	
T <sub>d(on)</sub>	Turn-On Delay Time	V <sub>DD</sub> =12V, V <sub>GS</sub> =10V, R <sub>G</sub> =3.3Ω I <sub>D</sub> =5A	---	4.5	---	ns
T <sub>r</sub>	Rise Time		---	10.8	---	
T <sub>d(off)</sub>	Turn-Off Delay Time		---	25.5	---	
T <sub>f</sub>	Fall Time		---	9.6	---	
C <sub>iss</sub>	Input Capacitance	V <sub>DS</sub> =15V, V <sub>GS</sub> =0V, f=1MHz	---	1200	---	pF
C <sub>oss</sub>	Output Capacitance		---	163	---	
C <sub>rss</sub>	Reverse Transfer Capacitance		---	131	---	

**Diode Characteristics**

Symbol	Parameter	Conditions	Min.	Typ.	Max.	Unit
I <sub>S</sub>	Continuous Source Current <sup>1,6</sup>	V <sub>G</sub> =V <sub>D</sub> =0V, Force Current	---	---	50	A
I <sub>SM</sub>	Pulsed Source Current <sup>2,6</sup>		---	---	120	A
V <sub>SD</sub>	Diode Forward Voltage <sup>2</sup>	V <sub>GS</sub> =0V, I <sub>S</sub> =1A, T <sub>J</sub> =25°C	---	---	1.2	V

Note :

1. The data tested by surface mounted on a 1 inch<sup>2</sup> FR-4 board with 2OZ copper.
2. The data tested by pulsed, pulse width ≤ 300us, duty cycle ≤ 2%
3. The EAS data shows Max. rating. The test condition is V<sub>DD</sub>=25V, V<sub>GS</sub>=10V, L=0.1mH, I<sub>AS</sub>=34A
4. The power dissipation is limited by 150°C junction temperature
5. The data is theoretically the same as I<sub>D</sub> and I<sub>DM</sub>, in real applications, should be limited by total power dissipation.

Typical Characteristics

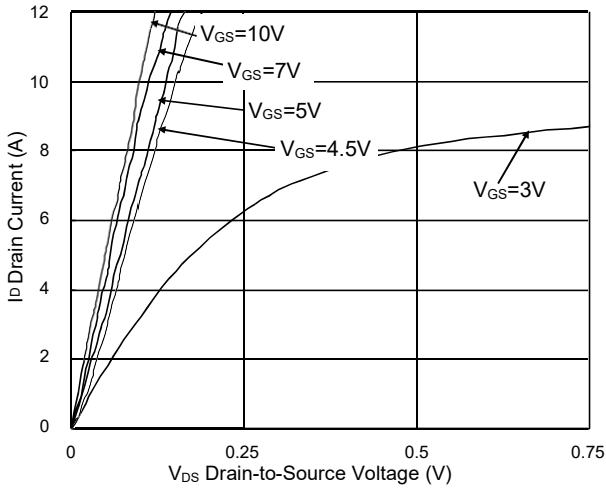


Fig.1 Typical Output Characteristics

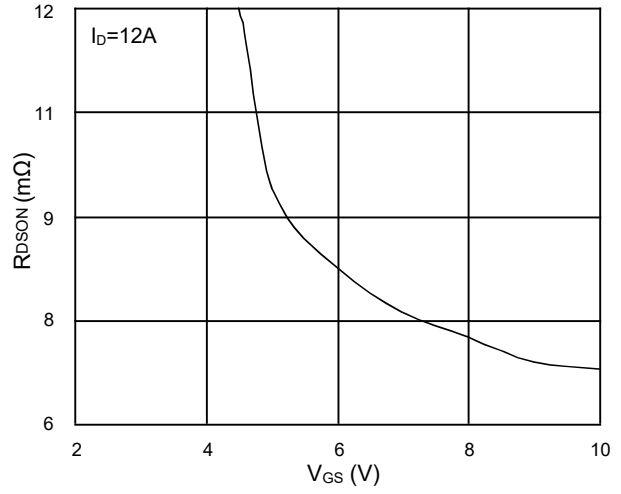


Fig.2 On-Resistance vs. G-S Voltage

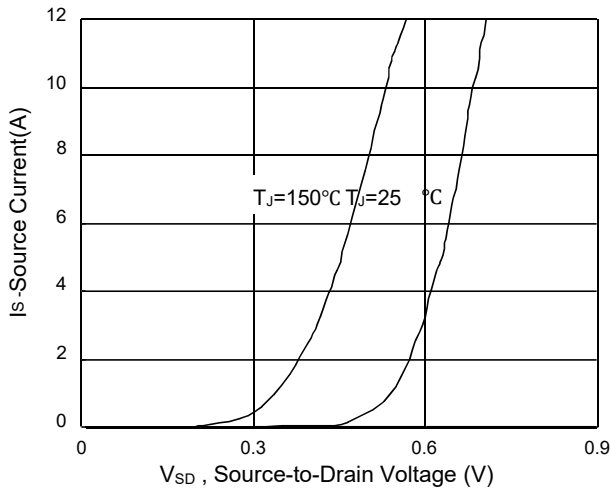


Fig.3 Forward Characteristics of Reverse

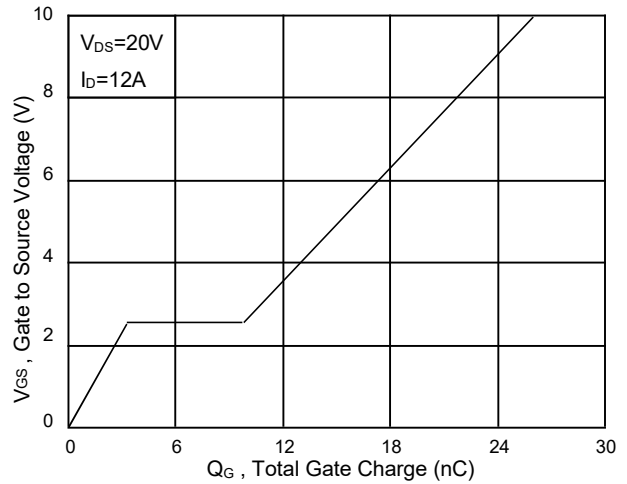


Fig.4 Gate-Charge Characteristics

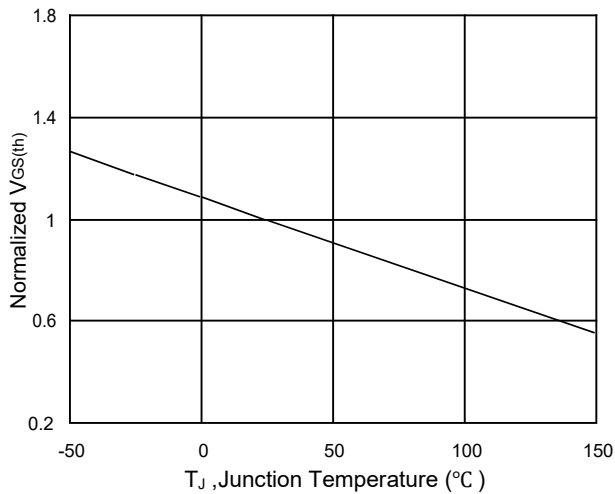


Fig.5 Normalized  $V_{GS(th)}$  vs.  $T_J$

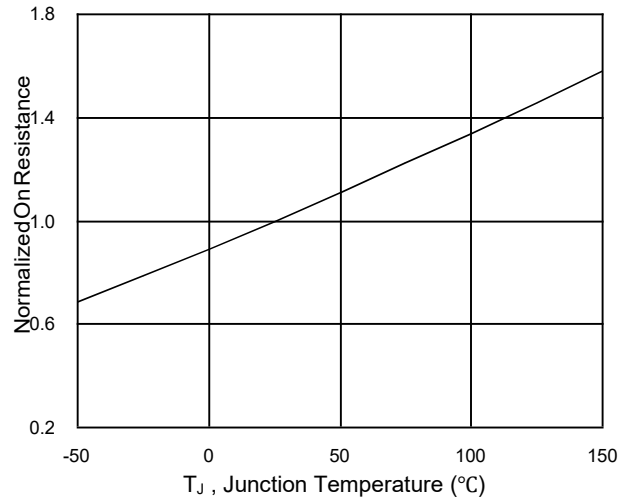
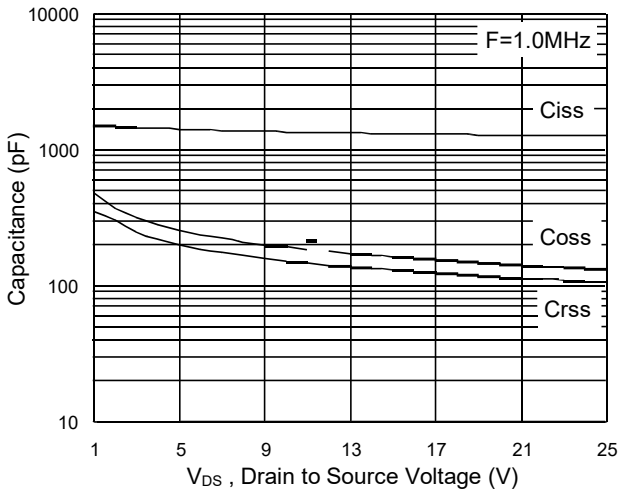


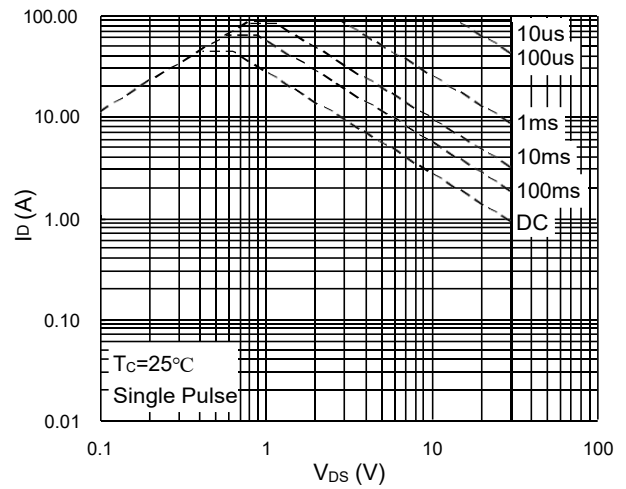
Fig.6 Normalized  $R_{DS(on)}$  vs.  $T_J$

**TM50N03DF**

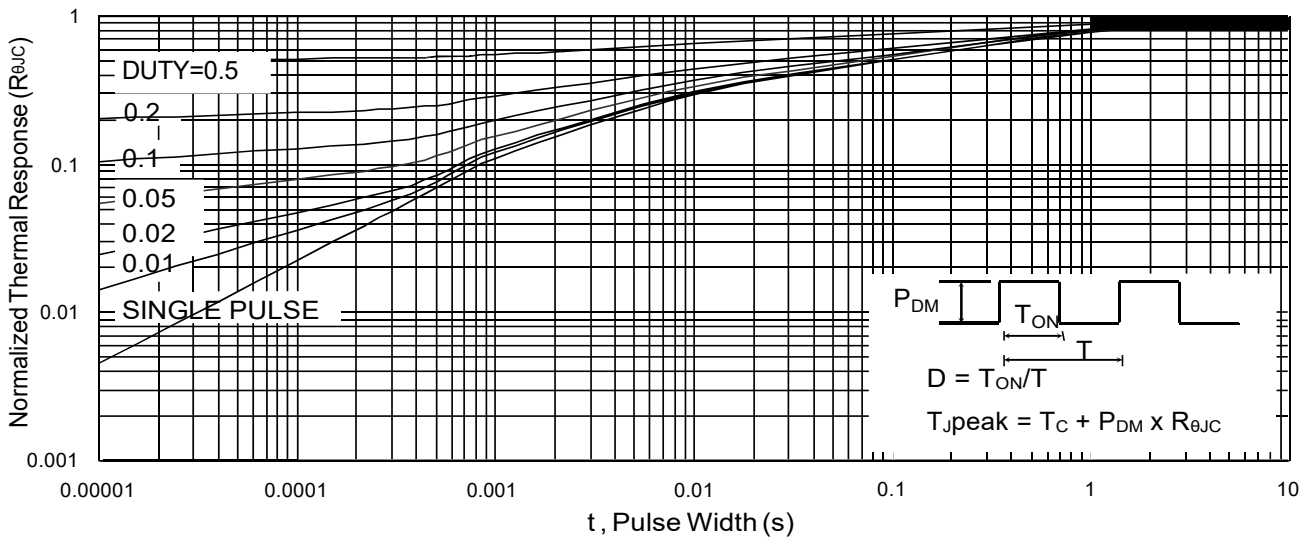
**N-Channel Enhancement Mosfet**



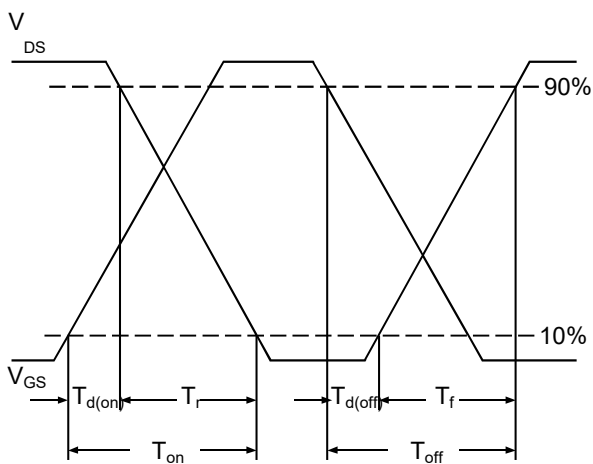
**Fig.7 Capacitance**



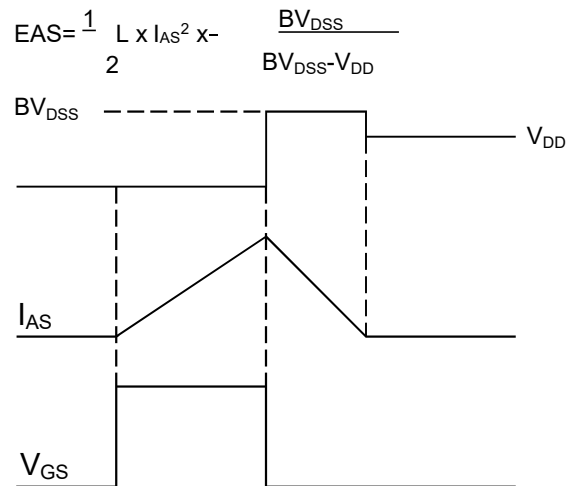
**Fig.8 Safe Operating Area**



**Fig.9 Normalized Maximum Transient Thermal Impedance**

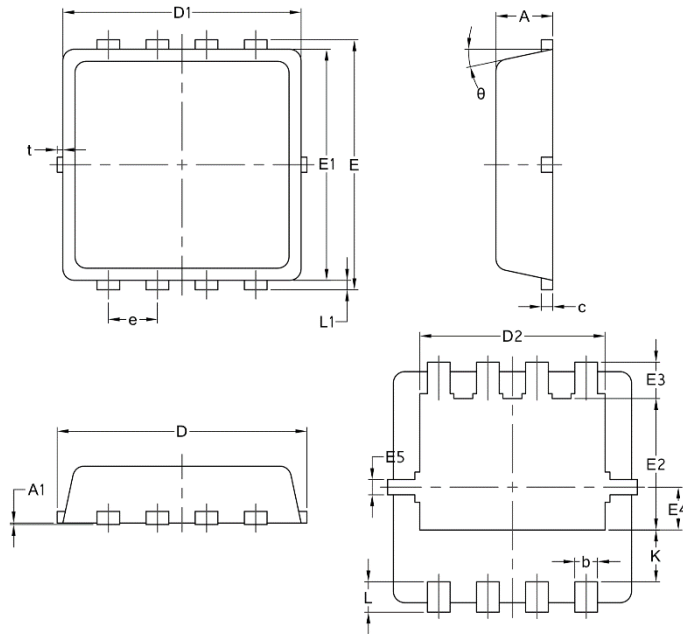


**Fig.10 Switching Time Waveform**



**Fig.11 Unclamped Inductive Switching Waveform**

## Package Mechanical Data: DFN3x3-8L



Symbol	Common		
	mm		
	Mim	Nom	Max
A	0.70	0.75	0.85
A1	/	/	0.05
b	0.20	0.30	0.40
c	0.10	0.152	0.25
D	3.15	3.30	3.45
D1	3.00	3.15	3.25
D2	2.29	2.45	2.65
E	3.15	3.30	3.45
E1	2.90	3.05	3.20
E2	1.54	1.74	1.94
E3	0.28	0.48	0.65
E4	0.37	0.57	0.77
E5	0.10	0.20	0.30
e	0.60	0.65	0.70
K	0.59	0.69	0.89
L	0.30	0.40	0.50
L1	0.06	0.125	0.20
t	0	0.075	0.13
Φ	10	12	14

## X-ON Electronics

Largest Supplier of Electrical and Electronic Components

*Click to view similar products for [MOSFET](#) category:*

*Click to view products by [Tritech-MOS](#) manufacturer:*

Other Similar products are found below :

[IRFD120](#) [JANTX2N5237](#) [BUK455-60A/B](#) [MIC4420CM-TR](#) [VN1206L](#) [NDP4060](#) [SI4482DY](#) [IPS70R2K0CEAKMA1](#) [SQD23N06-31L-GE3](#)  
[TK16J60W,S1VQ\(O](#) [2SK2614\(TE16L1,Q\)](#) [DMN1017UCP3-7](#) [DMN1053UCP4-7](#) [SQJ469EP-T1-GE3](#) [NTE2384](#) [DMC2700UDMQ-7](#)  
[DMN2080UCB4-7](#) [DMN61D9UWQ-13](#) [US6M2GTR](#) [DMN31D5UDJ-7](#) [DMP22D4UFO-7B](#) [DMN1006UCA6-7](#) [DMN16M9UCA6-7](#)  
[STF5N65M6](#) [IRF40H233XTMA1](#) [STU5N65M6](#) [DMN6022SSD-13](#) [DMN13M9UCA6-7](#) [DMTH10H4M6SPS-13](#) [DMN2990UFB-7B](#)  
[IPB80P04P405ATMA2](#) [2N7002W-G](#) [MCAC30N06Y-TP](#) [MCQ7328-TP](#) [NTMC083NP10M5L](#) [BXP7N65D](#) [BXP4N65F](#) [AOL1454G](#)  
[WMJ80N60C4](#) [BXP2N20L](#) [BXP2N65D](#) [BXT1150N10J](#) [BXT1700P06M](#) [TSM60NB380CP](#) [ROG](#) [RQ7L055BGTGR](#) [DMNH15H110SK3-13](#)  
[SLF10N65ABV2](#) [BSO203SP](#) [BSO211P](#) [IPA60R230P6](#)