

TM50N03YS

N-Channel Enhancement Mosfet

<p><b>General Description</b></p> <ul style="list-style-type: none"> <li>• Low <math>R_{DS(ON)}</math></li> <li>• RoHS and Halogen-Free Compliant</li> </ul> <p><b>Applications</b></p> <ul style="list-style-type: none"> <li>• Load switch</li> <li>• PWM</li> </ul>	<p><b>General Features</b></p> <p><math>V_{DS} = 30V</math> <math>I_D = 50A</math></p> <p><math>R_{DS(ON)} = 7.6 m\Omega</math> (typ.) @ <math>V_{GS} = 10V</math></p> <p>100% UIS Tested              100% <math>R_g</math> Tested</p> 
--	---

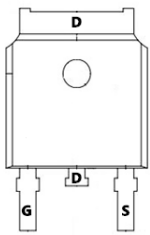

Y:TO-251S-3L

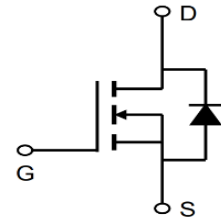
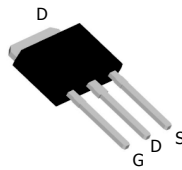

Marking: 50N03

Absolute Maximum Ratings				
Symbol	Parameter	Rating		Units
		10s	Steady State	
$V_{DS}$	Drain-Source Voltage	30		V
$V_{GS}$	Gate-Source Voltage	$\pm 20$		V
$I_D @ T_C = 25^\circ C$	Continuous Drain Current, $V_{GS} @ 10V^1$	50		A
$I_D @ T_C = 100^\circ C$	Continuous Drain Current, $V_{GS} @ 10V^1$	26		A
$I_{DM}$	Pulsed Drain Current <sup>2</sup>	168		A
EAS	Single Pulse Avalanche Energy <sup>3</sup>	33		mJ
$I_{AS}$	Avalanche Current	23.8		A
$P_D @ T_C = 25^\circ C$	Total Power Dissipation <sup>4</sup>	30.5		W
$T_{STG}$	Storage Temperature Range	-55 to 175		$^\circ C$
$T_J$	Operating Junction Temperature Range	-55 to 175		$^\circ C$

Thermal Data				
Symbol	Parameter	Typ.	Max.	Unit
$R_{\theta JC}$	Thermal Resistance Junction-Case <sup>1</sup>	---	5.26	$^\circ C/W$

**Electrical Characteristics** ( $T_J=25^{\circ}\text{C}$  unless otherwise specified)

Symbol	Parameter	Test Condition	Min.	Typ.	Max.	Units
<b>Off Characteristic</b>						
$V_{(BR)DSS}$	Drain-Source Breakdown Voltage	$V_{GS}=0V, I_D=250\mu A$	30	-	-	V
$I_{DSS}$	Zero Gate Voltage Drain Current	$V_{DS}=30V, V_{GS}=0V,$	-	-	1.0	$\mu A$
$I_{GSS}$	Gate to Body Leakage Current	$V_{DS}=0V, V_{GS}=\pm 20V$	-	-	$\pm 100$	nA
<b>On Characteristics</b>						
$V_{GS(th)}$	Gate Threshold Voltage	$V_{DS}=V_{GS}, I_D=250\mu A$	1.0	1.5	2.5	V
$R_{DS(on)}$	Static Drain-Source on-Resistance note3	$V_{GS}=10V, I_D=20A$	-	7.6	10	m $\Omega$
		$V_{GS}=4.5V, I_D=10A$	-	10.2	17	
<b>Dynamic Characteristics</b>						
$C_{iss}$	Input Capacitance	$V_{DS}=15V, V_{GS}=0V,$ $f=1.0\text{MHz}$	-	1011	-	pF
$C_{oss}$	Output Capacitance		-	142	-	pF
$C_{rss}$	Reverse Transfer Capacitance		-	119	-	pF
$Q_g$	Total Gate Charge	$V_{DS}=15V, I_D=20A,$ $V_{GS}=10V$	-	19	-	nC
$Q_{gs}$	Gate-Source Charge		-	6.3	-	nC
$Q_{gd}$	Gate-Drain("Miller") Charge		-	4.5	-	nC
<b>Switching Characteristics</b>						
$t_{d(on)}$	Turn-on Delay Time	$V_{DS}=30V,$ $I_D=2A, R_{GEN}=3\Omega,$ $V_{GS}=10V$	-	6	-	ns
$t_r$	Turn-on Rise Time		-	5	-	ns
$t_{d(off)}$	Turn-off Delay Time		-	25	-	ns
$t_f$	Turn-off Fall Time		-	7	-	ns
<b>Drain-Source Diode Characteristics and Maximum Ratings</b>						
$I_S$	Maximum Continuous Drain to Source Diode Forward Current		-	-	50	A
$I_{SM}$	Maximum Pulsed Drain to Source Diode Forward Current		-	-	160	A
$V_{SD}$	Drain to Source Diode Forward Voltage	$V_{GS}=0V, I_S=30A$	-	-	1.2	V
$t_{rr}$	Body Diode Reverse Recovery Time	$I_F=30A, di/dt=100A/\mu s$	-	7	-	ns
$Q_{rr}$	Body Diode Reverse Recovery Charge		-	6.3	-	nC

- Notes: 1. Repetitive Rating: Pulse Width Limited by Maximum Junction Temperature  
 2. EAS condition:  $T_J=25^{\circ}\text{C}, V_{DD}=15V, V_G=10V, R_G=25\Omega, L=0.5\text{mH}, I_{AS}=11.5A$   
 3. Pulse Test: Pulse Width  $\leq 300\mu s$ , Duty Cycle  $\leq 0.5\%$

## Typical Performance Characteristics

Figure 1: Output Characteristics

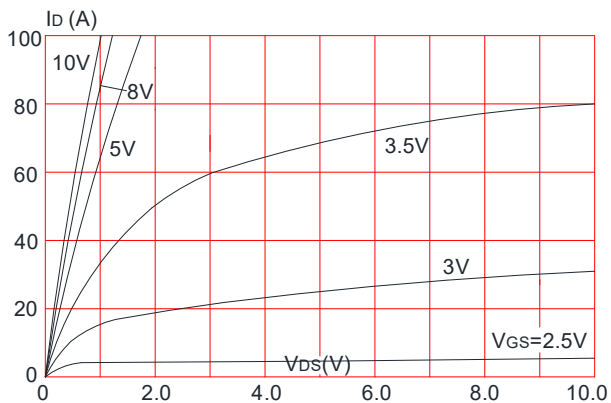

Figure 2: Typical Transfer Characteristics

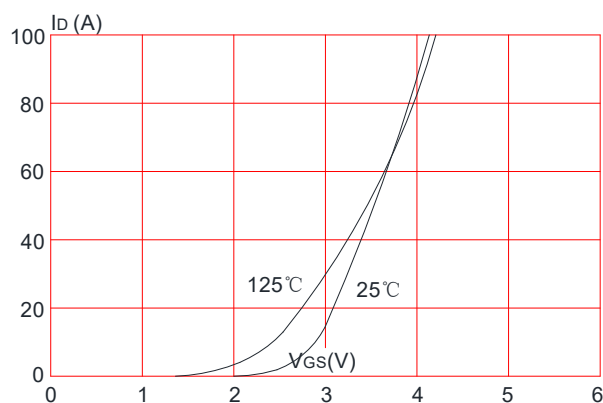

Figure 3: On-resistance vs. Drain Current

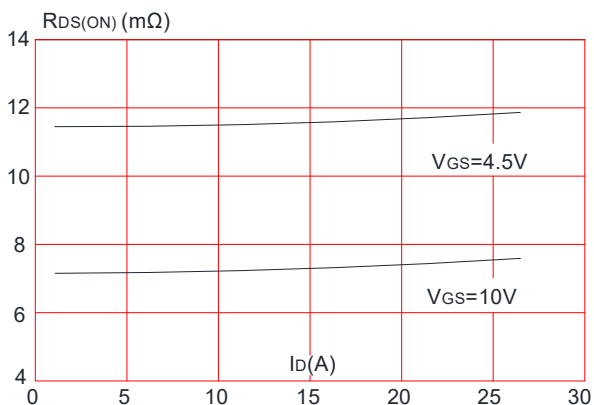

Figure 4: Body Diode Characteristics

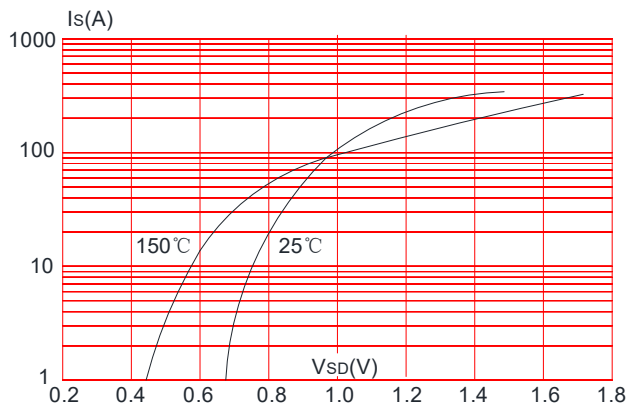

Figure 5: Gate Charge Characteristics

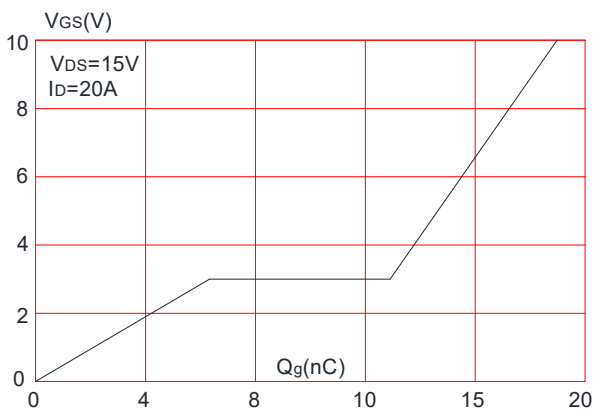
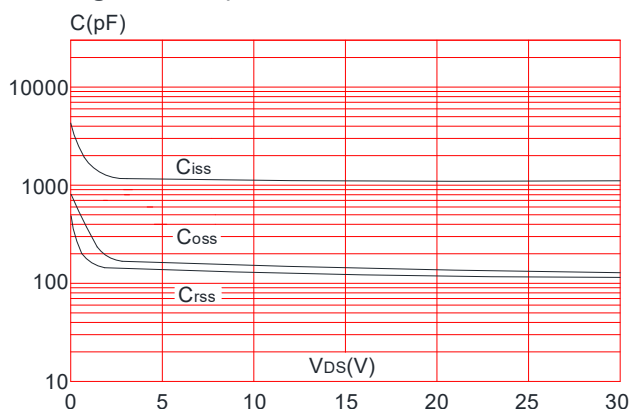

Figure 6: Capacitance Characteristics



TM50N03YS

N-Channel Enhancement Mosfet

Figure 7: Normalized Breakdown Voltage vs. Junction Temperature

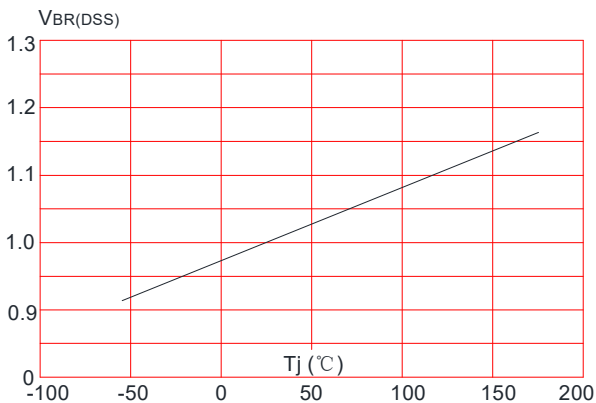

Figure 8: Normalized on Resistance vs. Junction Temperature

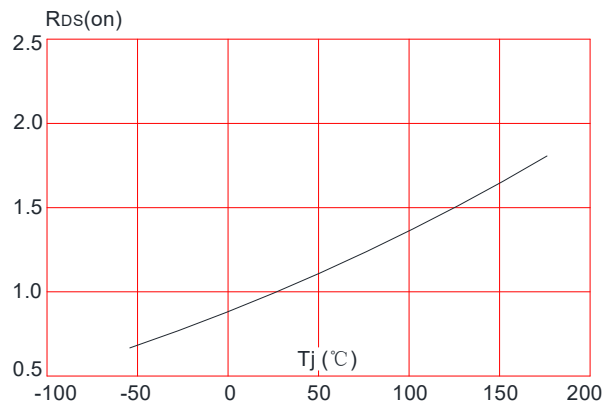

Figure 9: Maximum Safe Operating Area

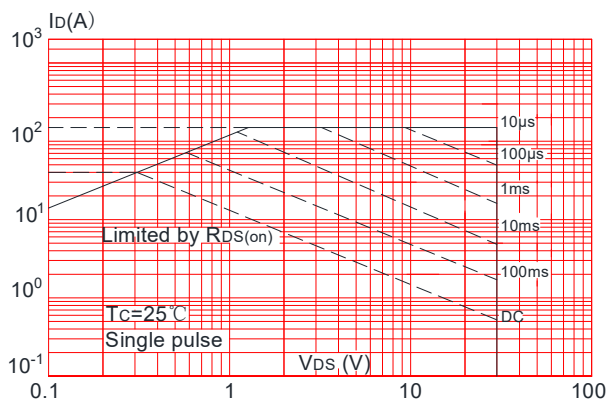
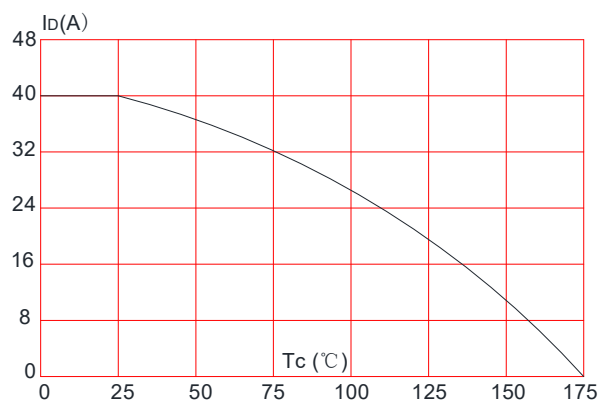
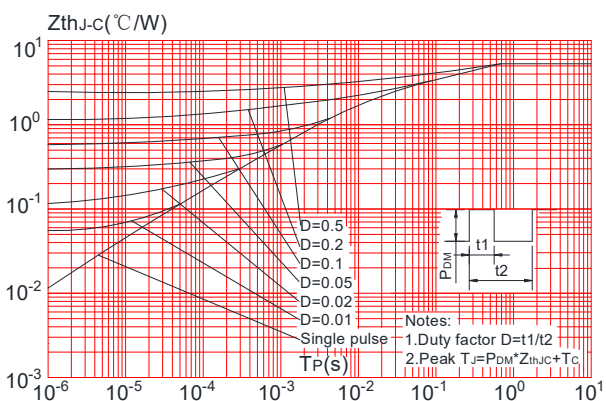

Figure 10: Maximum Continuous Drain Current vs. Case Temperature



Maximum Effective Transient Thermal Impedance, Junction-to-Case



**Test Circuit**

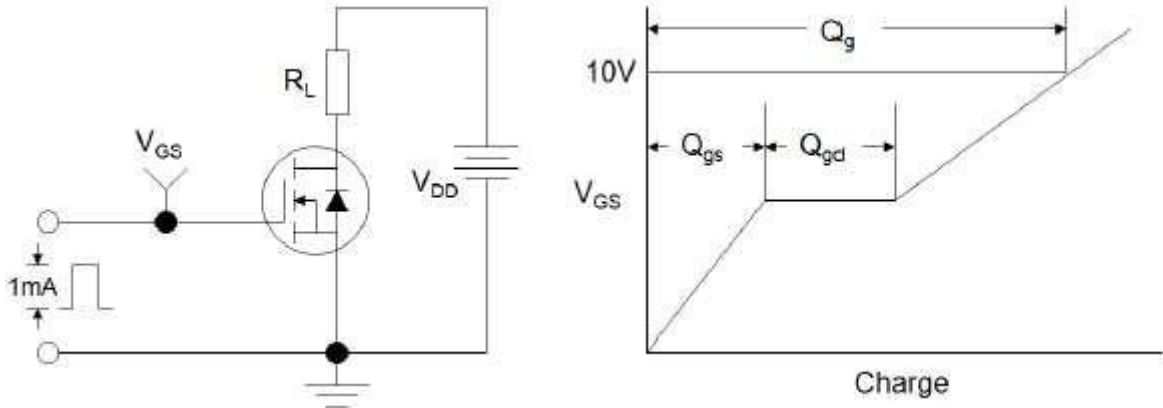

**Figure 1: Gate Charge Test Circuit & Waveform**

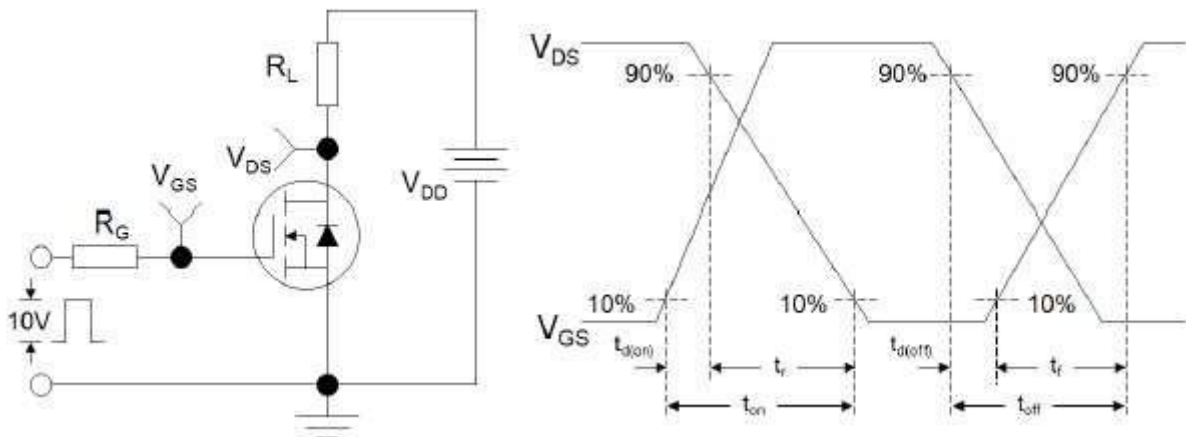

**Figure 2: Resistive Switching Test Circuit & Waveforms**

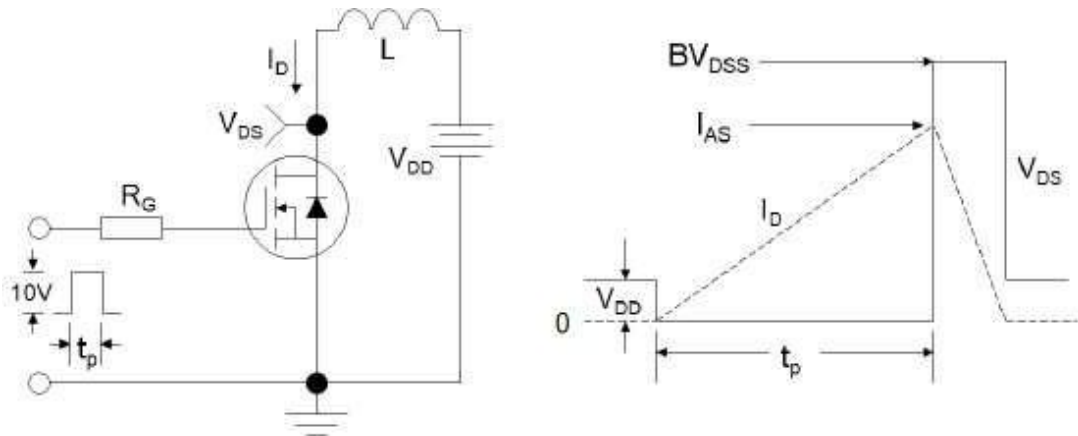
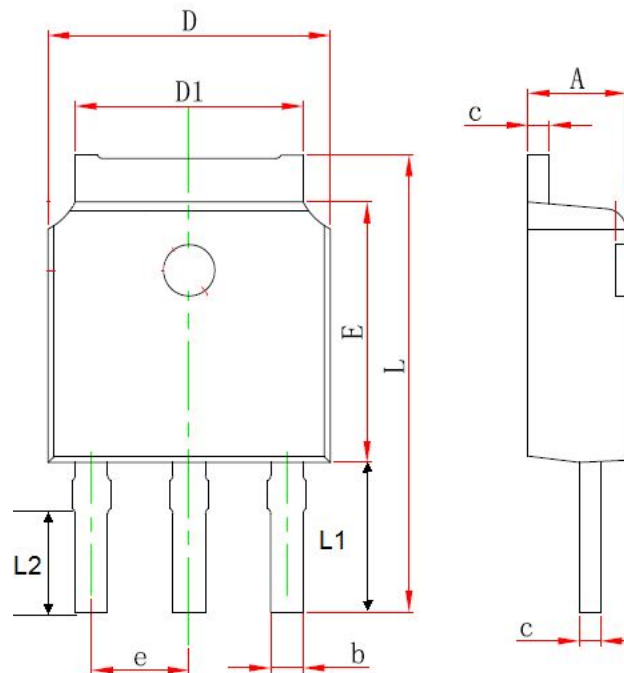

**Figure 3: Unclamped Inductive Switching Test Circuit & Waveforms**

## Package Information: TO-251S-3L

UNIT: mm

SYMBOL	min	nom	max
A	2.20		2.40
b	0.50		0.85
C	0.45	0.50	0.60
D	6.50		6.70
D1	5.10		5.50
E	5.9		6.20
e	2.18	2.29	2.38
L	11.00		12.40
L1	4.8		5.3
L2	3.5		4.2



## X-ON Electronics

Largest Supplier of Electrical and Electronic Components

*Click to view similar products for [MOSFET](#) category:*

*Click to view products by [Tritech-MOS](#) manufacturer:*

Other Similar products are found below :

[IRFD120](#) [JANTX2N5237](#) [BUK455-60A/B](#) [MIC4420CM-TR](#) [VN1206L](#) [NDP4060](#) [SI4482DY](#) [IPS70R2K0CEAKMA1](#) [SQD23N06-31L-GE3](#)  
[TK16J60W,S1VQ\(O](#) [2SK2614\(TE16L1,Q\)](#) [DMN1017UCP3-7](#) [DMN1053UCP4-7](#) [SQJ469EP-T1-GE3](#) [NTE2384](#) [DMC2700UDMQ-7](#)  
[DMN2080UCB4-7](#) [DMN61D9UWQ-13](#) [US6M2GTR](#) [DMN31D5UDJ-7](#) [DMP22D4UFO-7B](#) [DMN1006UCA6-7](#) [DMN16M9UCA6-7](#)  
[STF5N65M6](#) [IRF40H233XTMA1](#) [STU5N65M6](#) [DMN6022SSD-13](#) [DMN13M9UCA6-7](#) [DMTH10H4M6SPS-13](#) [DMN2990UFB-7B](#)  
[IPB80P04P405ATMA2](#) [2N7002W-G](#) [MCAC30N06Y-TP](#) [MCQ7328-TP](#) [BXP7N65D](#) [BXP4N65F](#) [AOL1454G](#) [WMJ80N60C4](#) [BXP2N20L](#)  
[BXP2N65D](#) [BXT1150N10J](#) [BXT1700P06M](#) [TSM60NB380CP](#) [ROG](#) [RQ7L055BGTCR](#) [DMNH15H110SK3-13](#) [SLF10N65ABV2](#)  
[BSO203SP](#) [BSO211P](#) [IPA60R230P6](#) [IPA60R460CE](#)