



TMG0069N04DF

N-Channel Enhancement Mosfet

General Description

- Low $R_{DS(ON)}$
- RoHS and Halogen-Free Compliant

Applications

- Load switch
- PWM

General Features

$V_{DS} = 40V$ $I_D = 60A$

$R_{DS(ON)} = 6.9m\Omega$ (typ.) @ $V_{GS} = 10V$

100% UIS Tested

100% R_g Tested

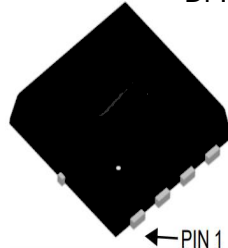
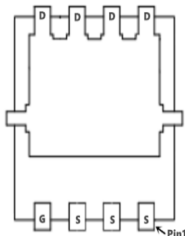
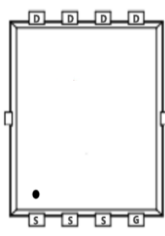

DF:DFN3x3_8L

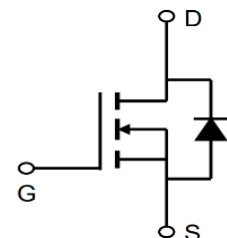
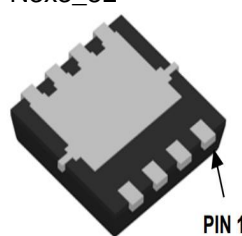

Marking: 60N04

Absolute Maximum Ratings ($T_A = 25^\circ C$ Unless Otherwise Noted)

| Symbol | Parameter | Rating | Units |
|---------------------------|--|------------|------------|
| V_{DS} | Drain-Source Voltage | 40 | V |
| V_{GS} | Gate-Source Voltage | ± 20 | V |
| $I_D @ T_C = 25^\circ C$ | Continuous Drain Current ¹ | 60 | A |
| $I_D @ T_C = 100^\circ C$ | Continuous Drain Current ¹ | 35 | A |
| I_{DM} | Pulsed Drain Current ² | 130 | A |
| EAS | Single Pulse Avalanche Energy ³ | 48 | mJ |
| I_{AS} | Avalanche Current | 35 | A |
| $P_D @ T_C = 25^\circ C$ | Total Power Dissipation ⁴ | 39 | W |
| T_{STG} | Storage Temperature Range | -55 to 150 | $^\circ C$ |
| T_J | Operating Junction Temperature Range | -55 to 150 | $^\circ C$ |

Thermal Data

| Symbol | Parameter | Typ. | Max. | Unit |
|-----------------|---|------|------|--------------|
| $R_{\theta JA}$ | Thermal Resistance Junction-ambient (Steady State) ¹ | --- | 60 | $^\circ C/W$ |
| $R_{\theta JC}$ | Thermal Resistance Junction-Case ¹ | --- | 3.2 | $^\circ C/W$ |

Electrical Characteristics (T_J=25 °C, unless otherwise noted)

| Symbol | Parameter | Conditions | Min. | Typ. | Max. | Unit |
|---------------------|--|--|------|------|------|------|
| BV _{DSS} | Drain-Source Breakdown Voltage | V _{GS} =0V, I _D =250uA | 40 | --- | --- | V |
| R _{DS(ON)} | Static Drain-Source On-Resistance ² | V _{GS} =10V, I _D =12A | --- | 6.9 | 8.5 | mΩ |
| | | V _{GS} =4.5V, I _D =10A | --- | 10.0 | 15 | |
| V _{GS(th)} | Gate Threshold Voltage | V _{GS} =V _{DS} , I _D =250uA | 1.35 | --- | 3 | V |
| I _{DSS} | Drain-Source Leakage Current | V _{DS} =32V, V _{GS} =0V, T _J =25°C | --- | --- | 1 | uA |
| | | V _{DS} =32V, V _{GS} =0V, T _J =55°C | --- | --- | 5 | |
| I _{GSS} | Gate-Source Leakage Current | V _{GS} =±20V, V _{DS} =0V | --- | --- | ±100 | nA |
| R _g | Gate Resistance | V _{DS} =0V, V _{GS} =0V, f=1MHz | --- | 1.7 | --- | Ω |
| Q _g | Total Gate Charge (4.5V) | V _{DS} =20V, V _{GS} =4.5V, I _D =12A | --- | 5.8 | --- | nC |
| Q _{gs} | Gate-Source Charge | | --- | 3 | --- | |
| Q _{gd} | Gate-Drain Charge | | --- | 1.2 | --- | |
| T _{d(on)} | Turn-On Delay Time | V _{DD} =15V, V _{GS} =10V, R _G =3.3Ω I _D =1A | --- | 14.3 | --- | ns |
| T _r | Rise Time | | --- | 5.6 | --- | |
| T _{d(off)} | Turn-Off Delay Time | | --- | 20 | --- | |
| T _f | Fall Time | | --- | 11 | --- | |
| C _{iss} | Input Capacitance | V _{DS} =15V, V _{GS} =0V, f=1MHz | --- | 690 | --- | pF |
| C _{oss} | Output Capacitance | | --- | 193 | --- | |
| C _{rss} | Reverse Transfer Capacitance | | --- | 38 | --- | |

Diode Characteristics

| Symbol | Parameter | Conditions | Min. | Typ. | Max. | Unit |
|-----------------|--|---|------|------|------|------|
| I _S | Continuous Source Current ^{1,5} | V _G =V _D =0V, Force Current | --- | --- | 60 | A |
| V _{SD} | Diode Forward Voltage ² | V _{GS} =0V, I _S =1A, T _J =25°C | --- | --- | 1 | V |

Note :

- The data tested by surface mounted on a 1 inch² FR-4 board with 2OZ copper.
- The data tested by pulsed, pulse width ≤ 300us, duty cycle ≤ 2%
- The EAS data shows Max. rating. The test condition is V_{DD}=25V, V_{GS}=10V, L=0.1mH, I_{AS}=31A
- The power dissipation is limited by 150°C junction temperature
- The data is theoretically the same as I_D and I_{DM}, in real applications, should be limited by total power dissipation.



TMG0069N04DF

N-Channel Enhancement Mosfet

Typical Characteristics

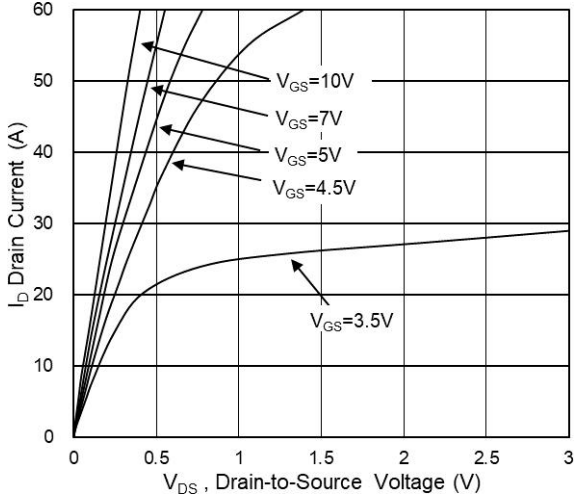

Fig.1 Typical Output Characteristics

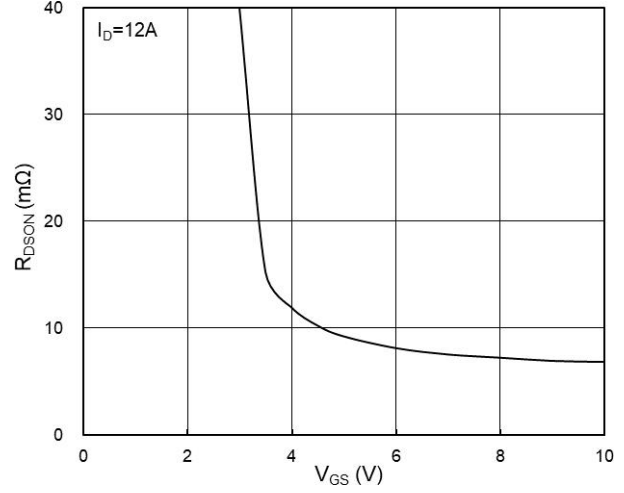

Fig.2 On-Resistance vs G-S Voltage

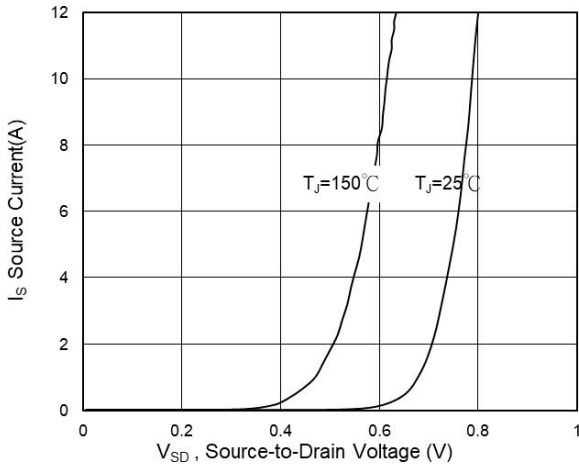

Fig.3 Source Drain Forward Characteristics

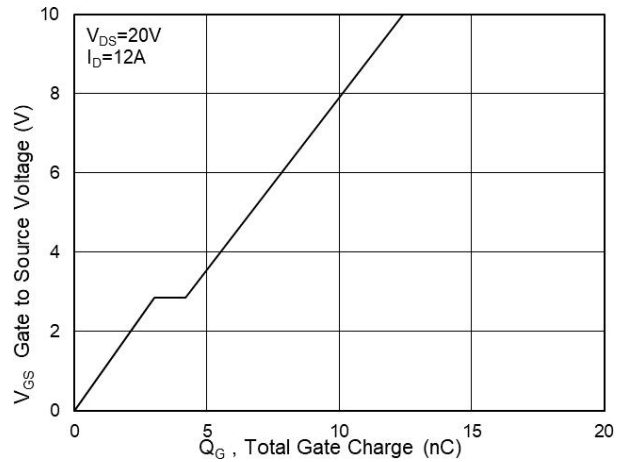

Fig.4 Gate-Charge Characteristics

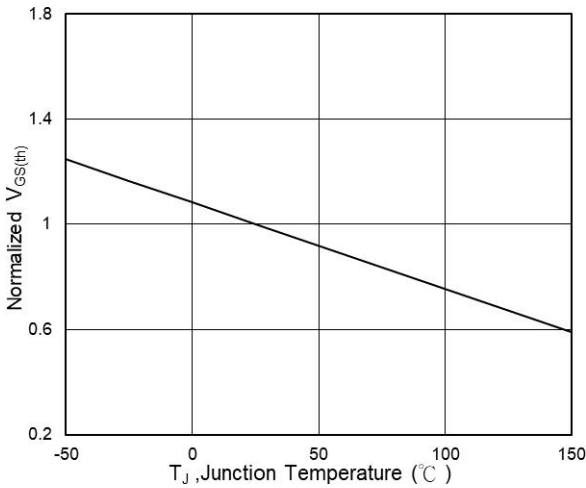

Fig.5 Normalized $V_{GS(th)}$ vs T_J

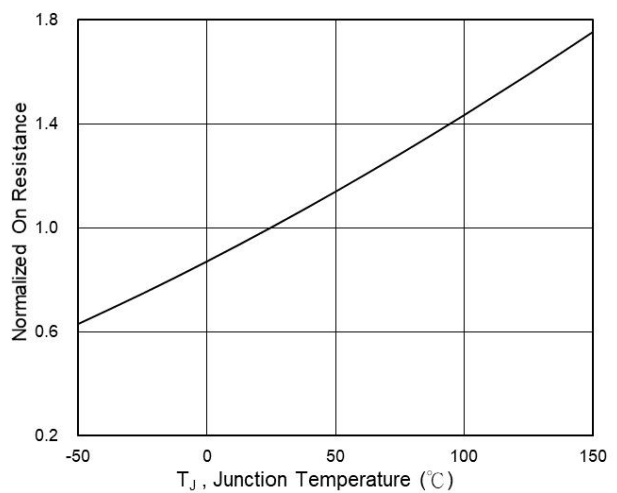

Fig.6 Normalized $R_{DS(on)}$ vs T_J

TMG0069N04DF

N-Channel Enhancement Mosfet

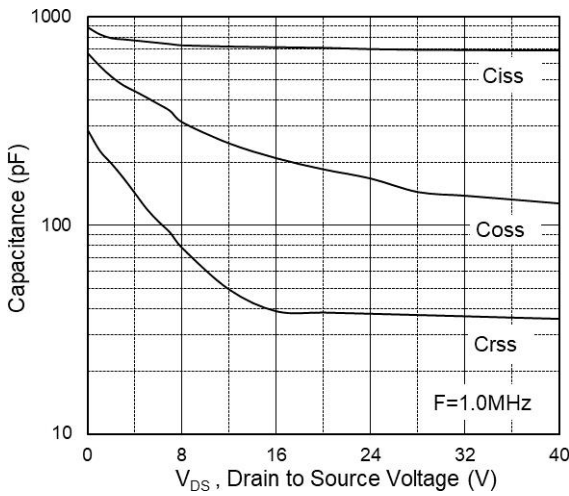

Fig.7 Capacitance

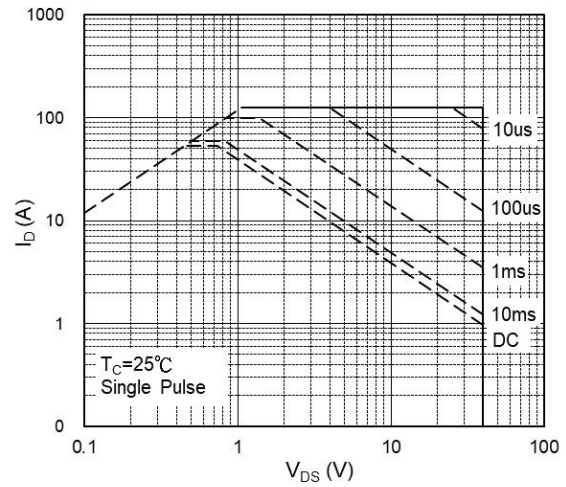

Fig.8 Safe Operating Area

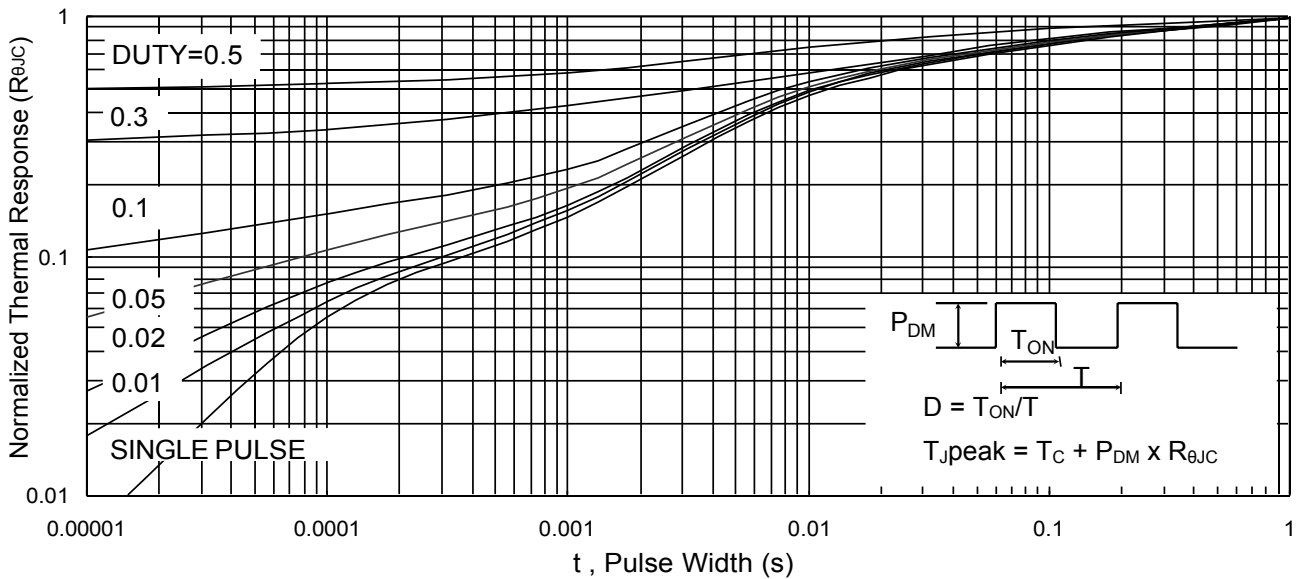

Fig.9 Normalized Maximum Transient Thermal Impedance

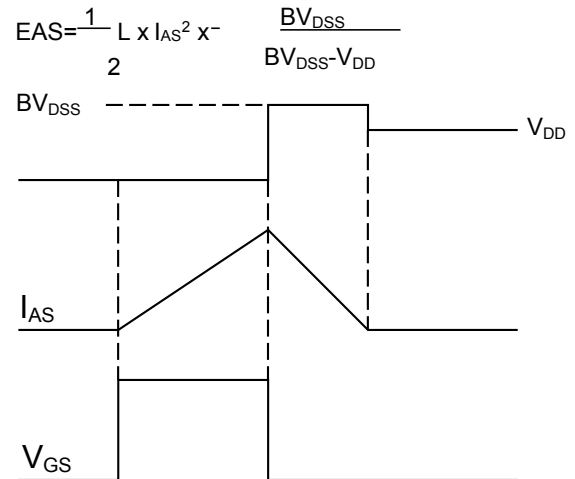
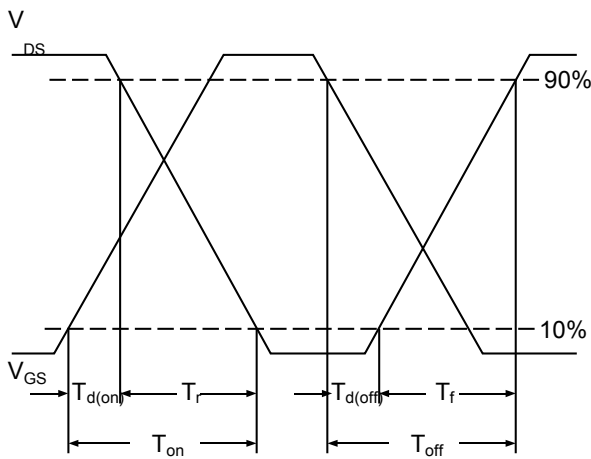
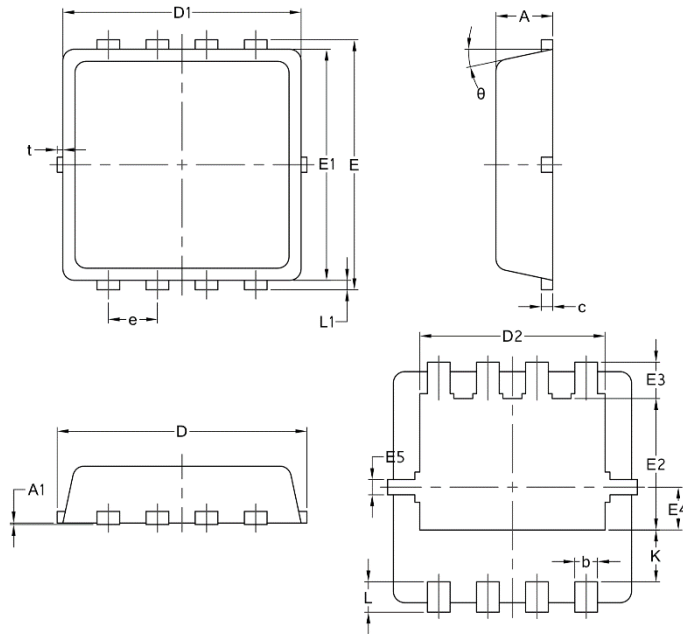

Fig.11 Unclamped Inductive Waveform

Package Mechanical Data:DFN3x3–8L



| Symbol | Common | | |
|--------|--------|-------|------|
| | mm | | |
| | Mim | Nom | Max |
| A | 0.70 | 0.75 | 0.85 |
| A1 | / | / | 0.05 |
| b | 0.20 | 0.30 | 0.40 |
| c | 0.10 | 0.152 | 0.25 |
| D | 3.15 | 3.30 | 3.45 |
| D1 | 3.00 | 3.15 | 3.25 |
| D2 | 2.29 | 2.45 | 2.65 |
| E | 3.15 | 3.30 | 3.45 |
| E1 | 2.90 | 3.05 | 3.20 |
| E2 | 1.54 | 1.74 | 1.94 |
| E3 | 0.28 | 0.48 | 0.65 |
| E4 | 0.37 | 0.57 | 0.77 |
| E5 | 0.10 | 0.20 | 0.30 |
| e | 0.60 | 0.65 | 0.70 |
| K | 0.59 | 0.69 | 0.89 |
| L | 0.30 | 0.40 | 0.50 |
| L1 | 0.06 | 0.125 | 0.20 |
| t | 0 | 0.075 | 0.13 |
| Φ | 10 | 12 | 14 |

X-ON Electronics

Largest Supplier of Electrical and Electronic Components

Click to view similar products for [MOSFET](#) category:

Click to view products by [Tritech-MOS](#) manufacturer:

Other Similar products are found below :

[IRFD120](#) [JANTX2N5237](#) [BUK455-60A/B](#) [MIC4420CM-TR](#) [VN1206L](#) [NDP4060](#) [SI4482DY](#) [IPS70R2K0CEAKMA1](#) [SQD23N06-31L-GE3](#)
[TK16J60W,S1VQ\(O](#) [2SK2614\(TE16L1,Q\)](#) [DMN1017UCP3-7](#) [DMN1053UCP4-7](#) [SQJ469EP-T1-GE3](#) [NTE2384](#) [DMC2700UDMQ-7](#)
[DMN2080UCB4-7](#) [DMN61D9UWQ-13](#) [US6M2GTR](#) [DMN31D5UDJ-7](#) [DMP22D4UFO-7B](#) [DMN1006UCA6-7](#) [DMN16M9UCA6-7](#)
[STF5N65M6](#) [IRF40H233XTMA1](#) [STU5N65M6](#) [DMN6022SSD-13](#) [DMN13M9UCA6-7](#) [DMTH10H4M6SPS-13](#) [DMN2990UFB-7B](#)
[IPB80P04P405ATMA2](#) [2N7002W-G](#) [MCAC30N06Y-TP](#) [MCQ7328-TP](#) [BXP7N65D](#) [BXP4N65F](#) [AOL1454G](#) [WMJ80N60C4](#) [BXP2N20L](#)
[BXP2N65D](#) [BXT1150N10J](#) [BXT1700P06M](#) [TSM60NB380CP](#) [ROG](#) [RQ7L055BGTCR](#) [DMNH15H110SK3-13](#) [SLF10N65ABV2](#)
[BSO203SP](#) [BSO211P](#) [IPA60R230P6](#) [IPA60R460CE](#)