

TMH4020DF

N+N-Channel Enhancement Mosfet

General Description

- Low $R_{DS(ON)}$
- RoHS and Halogen-Free Compliant

Applications

- Load switch
- PWM

Product Summary

$V_{DS} = 40V$ $I_D = 20A$
 $R_{DS(ON)} = 17 m\Omega (Typ.) @ V_{GS} = 10V$
 100% UIS Tested
 100% R_g Tested

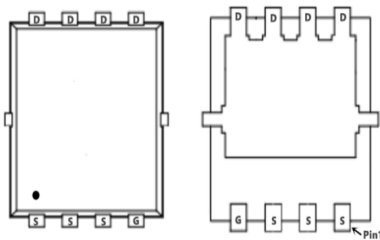

Marking:4886

DF:DFN3x3_8L

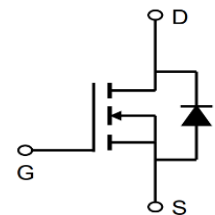
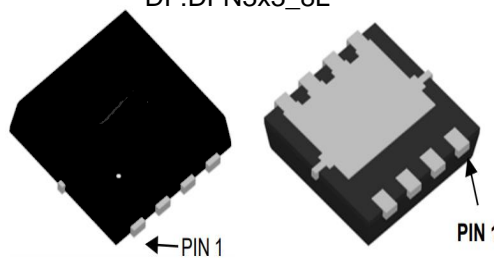

Absolute Maximum Ratings ($T_A = 25^\circ C$ Unless Otherwise Noted)

Symbol	Parameter	Rating	Units
V_{DS}	Drain-Source Voltage	40	V
V_{GS}	Gate-Source Voltage	± 20	V
$I_D @ T_C = 25^\circ C$	Continuous Drain Current, $V_{GS} @ 10V^1$	33	A
$I_D @ T_C = 100^\circ C$	Continuous Drain Current, $V_{GS} @ 10V^1$	21	A
I_{DM}	Pulsed Drain Current ²	55	A
EAS	Single Pulse Avalanche Energy ³	22.1	mJ
I_{AS}	Avalanche Current	10	A
$P_D @ T_C = 25^\circ C$	Total Power Dissipation ⁴	31.3	W
$P_D @ T_A = 25^\circ C$	Total Power Dissipation ⁴	2	W
T_{STG}	Storage Temperature Range	-55 to 150	$^\circ C$
T_J	Operating Junction Temperature Range	-55 to 150	$^\circ C$

Thermal Data

Symbol	Parameter	Typ.	Max.	Unit
$R_{\theta JA}$	Thermal Resistance Junction-ambient (Steady State) ¹	---	60	$^\circ C/W$
$R_{\theta JC}$	Thermal Resistance Junction-Case ¹	---	5.5	$^\circ C/W$



TMH4020DF

N+N-Channel Enhancement Mosfet

Electrical Characteristics (T_J=25 °C, unless otherwise noted)

Symbol	Parameter	Conditions	Min.	Typ.	Max.	Unit
BV _{DSS}	Drain-Source Breakdown Voltage	V _{GS} =0V, I _D =250uA	40	---	---	V
R _{DS(ON)}	Static Drain-Source On-Resistance ²	V _{GS} =10V, I _D =6A	---	17	26	mΩ
		V _{GS} =4.5V, I _D =5A	---	25	33	
V _{GS(th)}	Gate Threshold Voltage	V _{GS} =V _{DS} , I _D =250uA	1.0	1.5	2.5	V
I _{DSS}	Drain-Source Leakage Current	V _{DS} =32V, V _{GS} =0V, T _J =25°C	---	---	1	uA
		V _{DS} =32V, V _{GS} =0V, T _J =55°C	---	---	5	
I _{GSS}	Gate-Source Leakage Current	V _{GS} =±20V, V _{DS} =0V	---	---	±100	nA
g _{fs}	Forward Transconductance	V _{DS} =5V, I _D =12A	---	30	---	S
R _g	Gate Resistance	V _{DS} =0V, V _{GS} =0V, f=1MHz	---	2.1	---	Ω
Q _g	Total Gate Charge (4.5V)	V _{DS} =32V, V _{GS} =4.5V, I _D =6A	---	3.8	---	nC
Q _{gs}	Gate-Source Charge		---	2.8	---	
Q _{gd}	Gate-Drain Charge		---	1.1	---	
T _{d(on)}	Turn-On Delay Time	V _{DD} =20V, V _{GS} =10V, R _G =3.3Ω I _D =1A	---	12.2	---	ns
T _r	Rise Time		---	5.3	---	
T _{d(off)}	Turn-Off Delay Time		---	18	---	
T _f	Fall Time		---	9	---	
C _{iss}	Input Capacitance	V _{DS} =15V, V _{GS} =0V, f=1MHz	---	376	---	pF
C _{oss}	Output Capacitance		---	240	---	
C _{rss}	Reverse Transfer Capacitance		---	19	---	

Diode Characteristics

Symbol	Parameter	Conditions	Min.	Typ.	Max.	Unit
I _S	Continuous Source Current ^{1,5}	V _G =V _D =0V, Force Current	---	---	20	A
V _{SD}	Diode Forward Voltage ²	V _{GS} =0V, I _S =1A, T _J =25°C	---	---	1.2	V
t _{rr}	Reverse Recovery Time	I _F =6A, dI/dt=100A/μs, T _J =25°C	---	20	---	nS
Q _{rr}	Reverse Recovery Charge		---	35	---	nC

Note :

- 1.The data tested by surface mounted on a 1 inch²FR-4 board with 2OZ copper.
- 2.The data tested by pulsed , pulse width ≤ 300us , duty cycle ≤ 2%
- 3.The EAS data shows Max. rating . The test condition is V_{DD}=25V,V_{GS}=10V,L=0.1mH,I_{AS}=10A
- 4.The power dissipation is limited by 150°C junction temperature
- 5.The data is theoretically the same as I_D and I_{DM}, in real applications , should be limited by total power dissipation.

Typical Characteristics

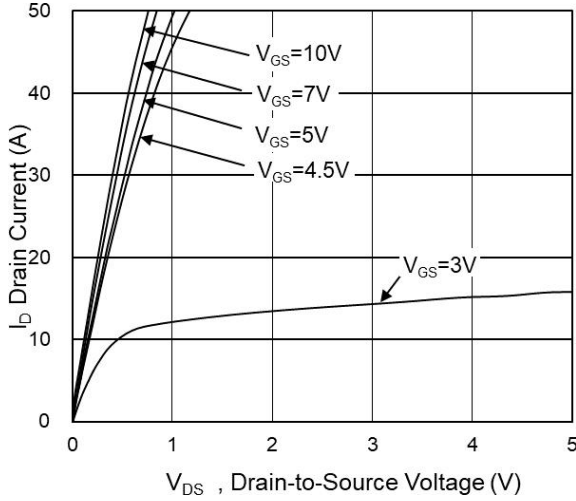

Fig.1 Typical Output Characteristics

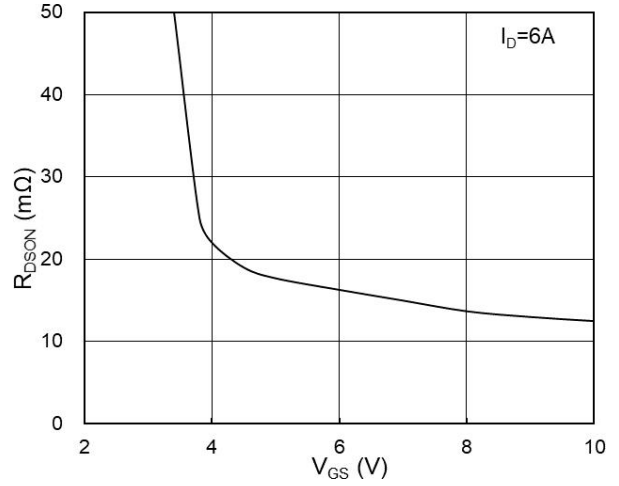

Fig.2 On-Resistance vs G-S Voltage

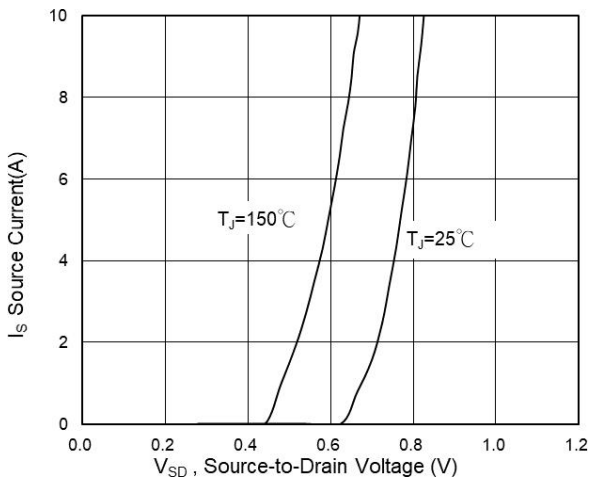

Fig.3 Source Drain Forward Characteristics

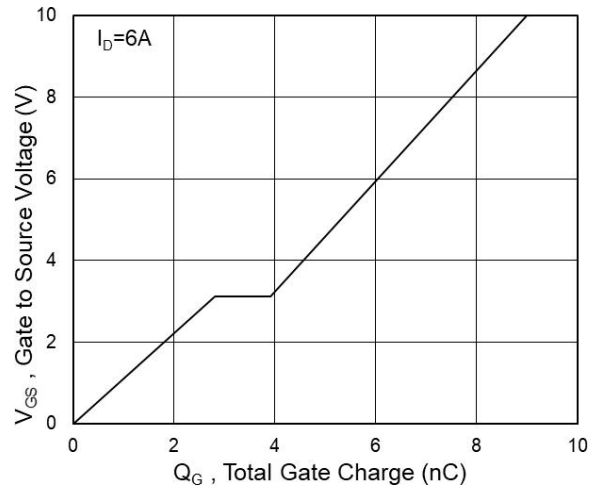

Fig.4 Gate-Charge Characteristics

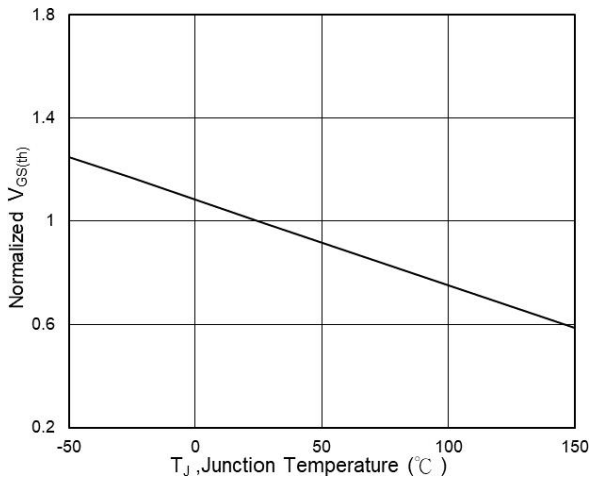

Fig.5 Normalized $V_{GS(th)}$ vs T_J

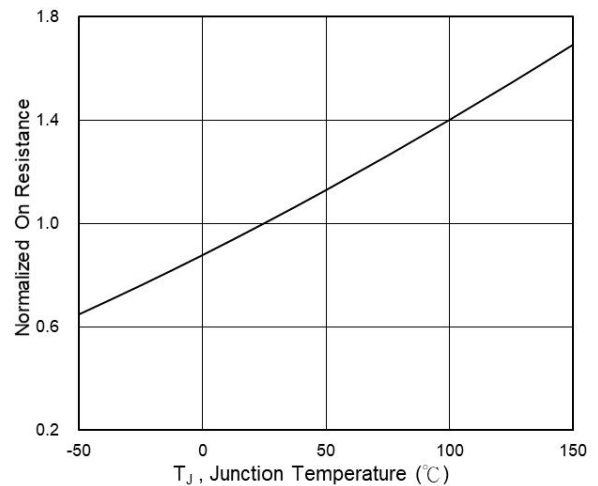

Fig.6 Normalized R_{DSON} vs T_J

TMH4020DF

N+N-Channel Enhancement Mosfet

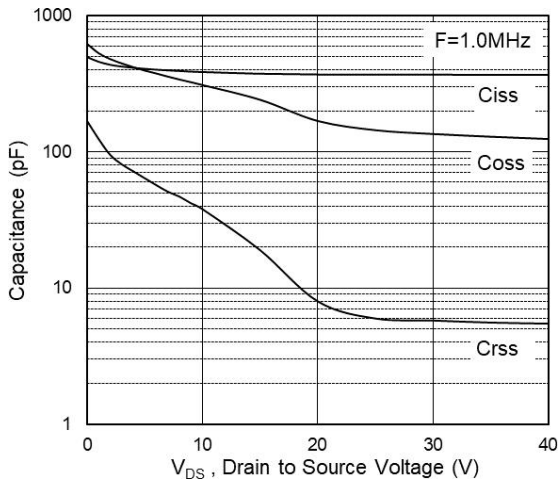

Fig.7 Capacitance

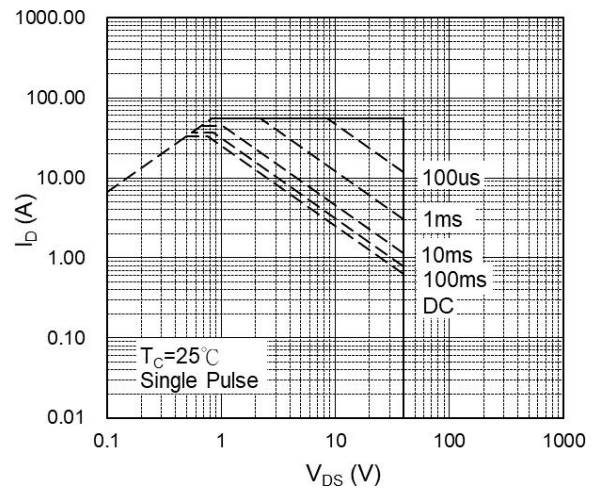

Fig.8 Safe Operating Area

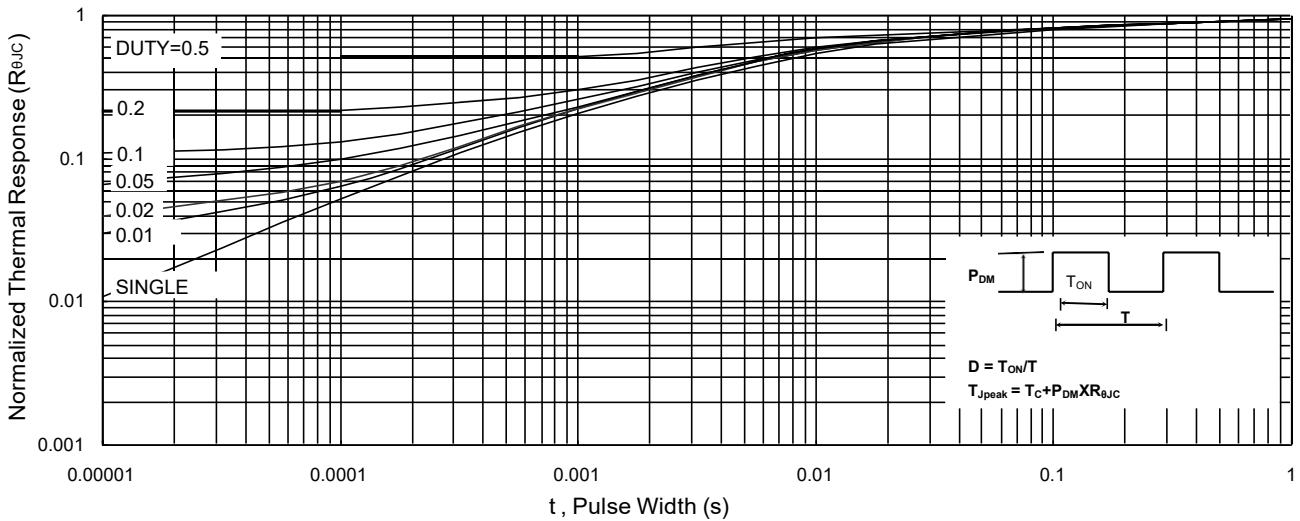

Fig.9 Normalized Maximum Transient Thermal Impedance

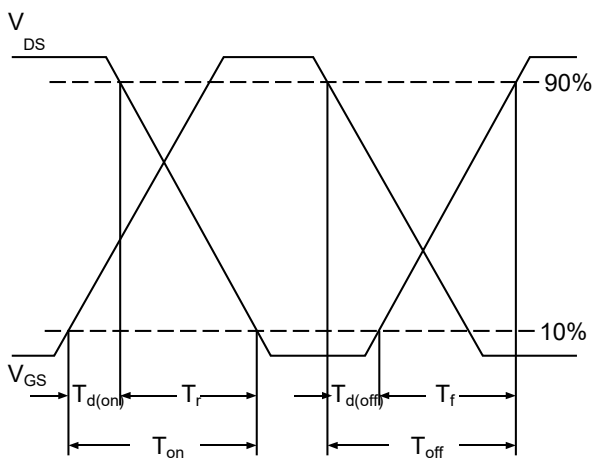

Fig.10 Switching Time Waveform

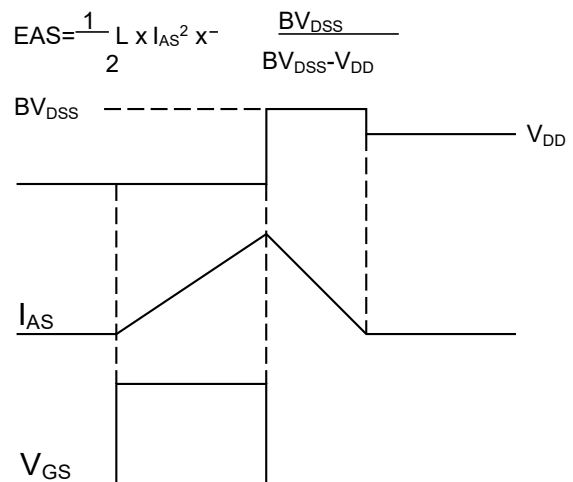
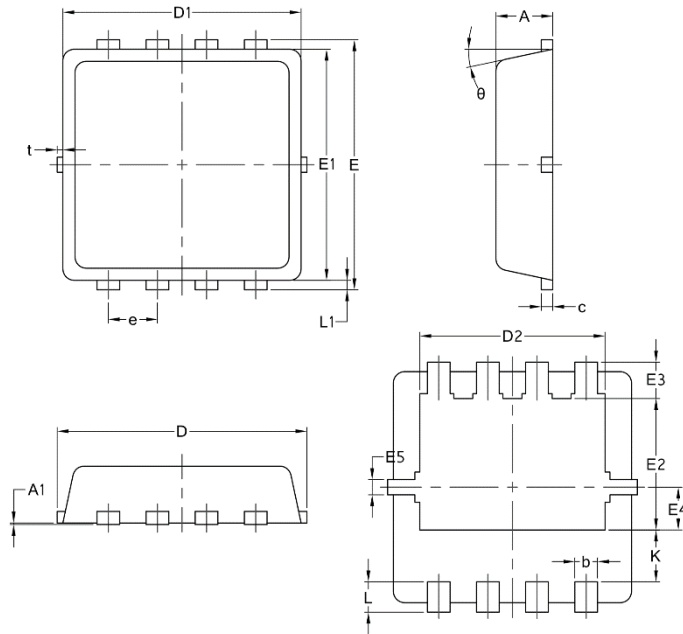

Fig.11 Unclamped Inductive Switching Waveform

Package Mechanical Data: DFN3x3-8L



Symbol	Common		
	mm		
	Mim	Nom	Max
A	0.70	0.75	0.85
A1	/	/	0.05
b	0.20	0.30	0.40
c	0.10	0.152	0.25
D	3.15	3.30	3.45
D1	3.00	3.15	3.25
D2	2.29	2.45	2.65
E	3.15	3.30	3.45
E1	2.90	3.05	3.20
E2	1.54	1.74	1.94
E3	0.28	0.48	0.65
E4	0.37	0.57	0.77
E5	0.10	0.20	0.30
e	0.60	0.65	0.70
K	0.59	0.69	0.89
L	0.30	0.40	0.50
L1	0.06	0.125	0.20
t	0	0.075	0.13
Φ	10	12	14

X-ON Electronics

Largest Supplier of Electrical and Electronic Components

Click to view similar products for [MOSFET](#) category:

Click to view products by [Tritech-MOS](#) manufacturer:

Other Similar products are found below :

[IRFD120](#) [JANTX2N5237](#) [BUK455-60A/B](#) [MIC4420CM-TR](#) [VN1206L](#) [NDP4060](#) [SI4482DY](#) [IPS70R2K0CEAKMA1](#) [SQD23N06-31L-GE3](#)
[TK16J60W,S1VQ\(O](#) [2SK2614\(TE16L1,Q\)](#) [DMN1017UCP3-7](#) [DMN1053UCP4-7](#) [SQJ469EP-T1-GE3](#) [NTE2384](#) [DMC2700UDMQ-7](#)
[DMN2080UCB4-7](#) [DMN61D9UWQ-13](#) [US6M2GTR](#) [DMN31D5UDJ-7](#) [DMP22D4UFO-7B](#) [DMN1006UCA6-7](#) [DMN16M9UCA6-7](#)
[STF5N65M6](#) [IRF40H233XTMA1](#) [STU5N65M6](#) [DMN6022SSD-13](#) [DMN13M9UCA6-7](#) [DMTH10H4M6SPS-13](#) [DMN2990UFB-7B](#)
[IPB80P04P405ATMA2](#) [2N7002W-G](#) [MCAC30N06Y-TP](#) [MCQ7328-TP](#) [NTMC083NP10M5L](#) [BXP7N65D](#) [BXP4N65F](#) [AOL1454G](#)
[WMJ80N60C4](#) [BXP2N20L](#) [BXP2N65D](#) [BXT1150N10J](#) [BXT1700P06M](#) [TSM60NB380CP](#) [ROG](#) [RQ7L055BGTGR](#) [DMNH15H110SK3-13](#)
[SLF10N65ABV2](#) [BSO203SP](#) [BSO211P](#) [IPA60R230P6](#)