

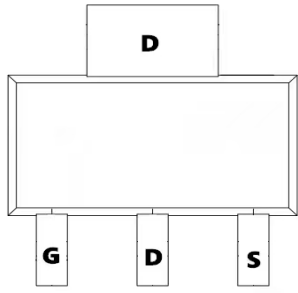

TMN10010MSI

N-Channel Enhancement Mosfet

<p>General Description</p> <ul style="list-style-type: none"> • Low $R_{DS(ON)}$ • RoHS and Halogen-Free Compliant <p>Applications</p> <ul style="list-style-type: none"> • Load switch • PWM 	<p>General Features</p> <p>$V_{DS} = 100V$ $I_D = 10A$</p> <p>$R_{DS(ON)} = 75\text{ m}\Omega$ (typ.) @ $V_{GS} = 10V$</p> <p>100% UIS Tested 100% R_g Tested</p> 
--	---



Marking: 10N10

MSI:SOT-223-3L

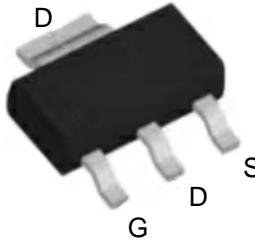

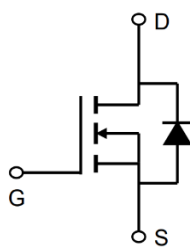

Absolute Maximum Ratings: ($T_A = 25^\circ\text{C}$ unless otherwise noted)

Symbol	Parameter	Ratings	Units
V_{DS}	Drain-Source Voltage	100	V
V_{GS}	Gate-Source Voltage	± 20	V
I_D	Continuous Drain Current ¹	10	A
	Continuous Drain Current- $T_A = 70^\circ\text{C}$ ¹	4	
I_{DM}	Pulsed Drain Current ²	24	
P_D	Power Dissipation ⁴	2.5	W
E_{AS}	Single pulse avalanche energy ³	10.1	mJ
T_J, T_{STG}	Operating and Storage Junction Temperature Range	-55-+150	$^\circ\text{C}$

Thermal Characteristics:

Symbol	Parameter	Max	Units
$R_{\theta JA}$	Thermal Resistance, Junction to ambient	50	$^\circ\text{C}/\text{W}$



TMN10010MSI

N-Channel Enhancement Mosfet

Electrical Characteristics: ($T_A=25^{\circ}\text{C}$ unless otherwise noted)

Symbol	Parameter	Conditions	Min	Typ	Max	Units
Off Characteristics						
BV_{DSS}	Drain-Source Breakdown Voltage	$V_{GS}=0V, I_D=250\ \mu A$	100	---	---	V
I_{DSS}	Zero Gate Voltage Drain Current	$V_{GS}=0V, V_{DS}=80V$	---	---	10	μA
I_{GSS}	Gate-Source Leakage Current	$V_{GS}=\pm 20V, V_{DS}=0A$	---	---	± 100	nA
On Characteristics						
$V_{GS(th)}$	GATE-Source Threshold Voltage	$V_{GS}=V_{DS}, I_D=250\ \mu A$	1.2	---	2.9	V
$R_{DS(on)}$	Drain-Source On Resistance ²	$V_{GS}=10V, I_D=5A$	---	75	90	m Ω
		$V_{GS}=4.5V, I_D=3A$	---	95	110	m Ω
Dynamic Characteristics						
C_{iss}	Input Capacitance	$V_{DS}=50V, V_{GS}=0V, f=1MHz$	---	1008	---	pF
C_{oss}	Output Capacitance		---	31	--	
C_{rss}	Reverse Transfer Capacitance		---	22	---	
Switching Characteristics						
$t_{d(on)}$	Turn-On Delay Time	$V_{DS}=50V, I_D=5A,$ $R_{ENG}=3\ \Omega, V_{GS}=10V$	---	37	---	ns
t_r	Rise Time		---	25.7	---	ns
$t_{d(off)}$	Turn-Off Delay Time		---	15	---	ns
t_f	Fall Time		---	8.7	---	ns
Q_{gs}	Total Gate Charge	$V_{GS}=10V, V_{DS}=50V,$ $I_D=5A$	---	16.3	---	nC
Q_{gd}	Gate-Source Charge		---	3.67	---	nC
Q_g	Gate-Drain "Miller" Charge		---	2.96	---	nC
Drain-Source Diode Characteristics						
V_{SD}	Diode Forward Voltage ²	$V_{GS}=0V, I_{SD}=1A$	---	---	1.2	V
I_S	Continuous Drain Current ^{1,5}	$V_D=V_G=0V$	---	---	10	A
I_{SM}	Pulsed Drain Current ^{2,5}		---	---	24	A

Notes:

- 1.The data tested by surface mounted on a 1 inch² FR-4 board with 2OZ copper.
- 2.The data tested by pulsed , pulse width $\leq 300\mu s$, duty cycle $\leq 2\%$
- 3.The EAS data shows Max. rating . The test condition is $V_{DD}=25V, V_{GS}=10V, L=1mH, I_{AS}=4.5A$
- 4.The power dissipation is limited by 150 $^{\circ}\text{C}$ junction temperature
- 5.The data is theoretically the same as I_D and I_{DM} , in real applications , should be limited by total power dissipation.



Typical Characteristics: (T_A=25°C unless otherwise noted)

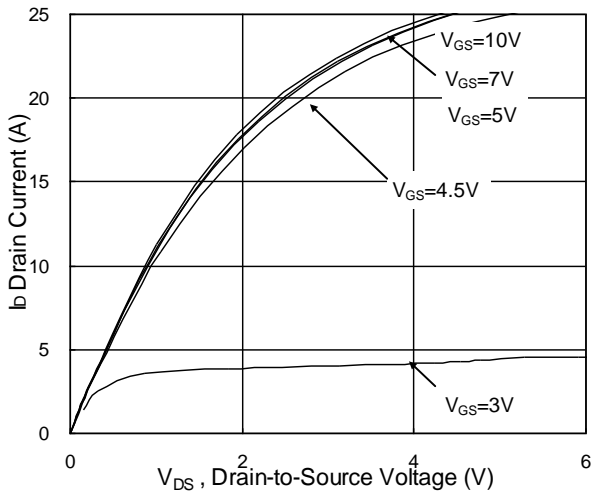

Fig.1 Typical Output Characteristics

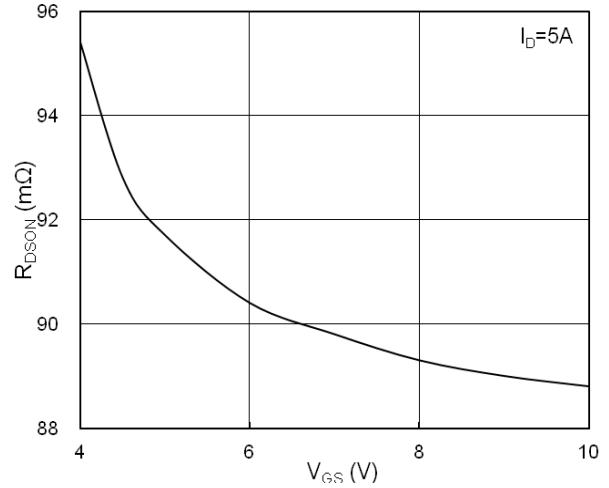

Fig.2 On-Resistance vs G-S Voltage

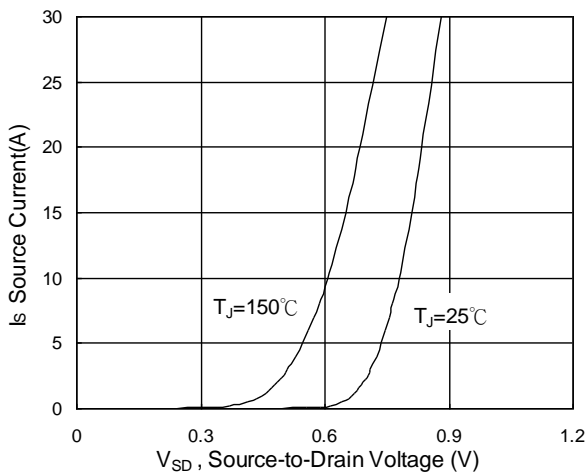

Fig.3 Source Drain Forward Characteristics

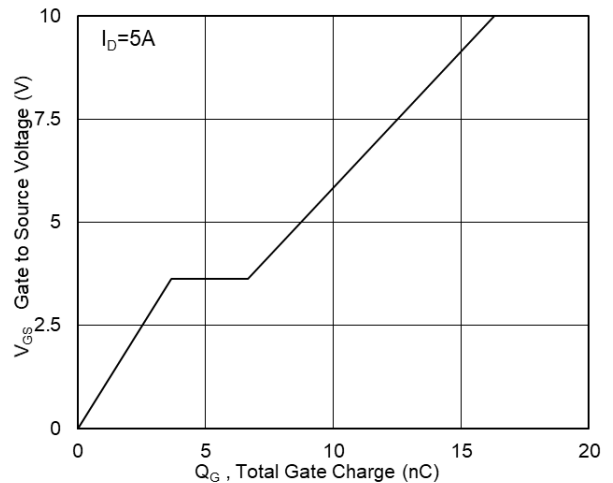

Fig.4 Gate-Charge Characteristics

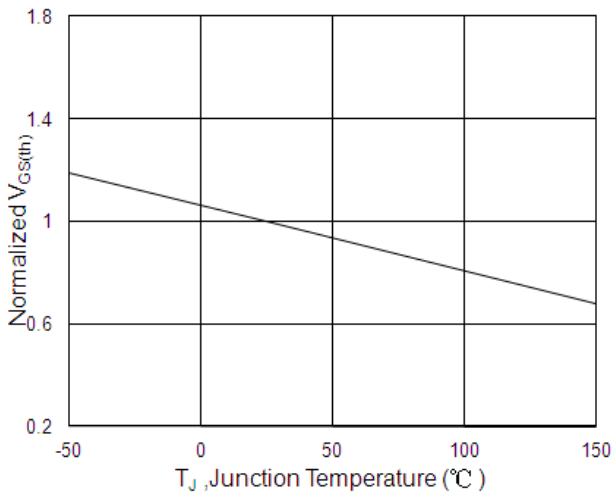

Fig.5 Normalized V_{GS(th)} vs T_J

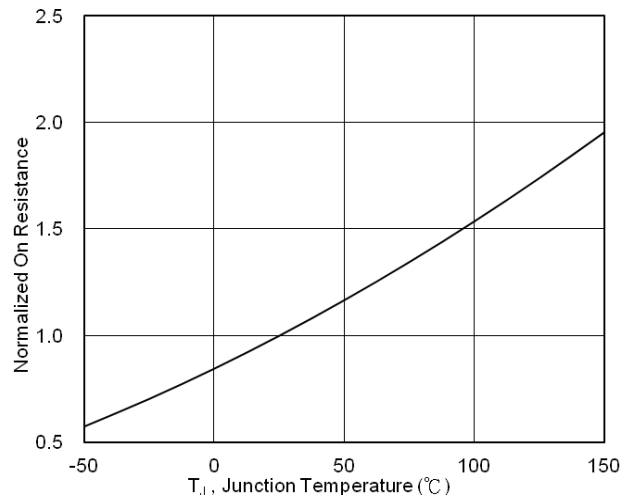

Fig.6 Normalized R_{DS(on)} vs T_J

TMN10010MSI

N-Channel Enhancement Mosfet

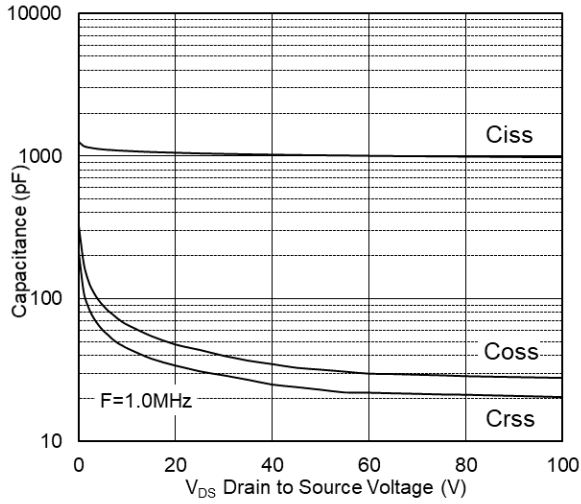

Fig.7 Capacitance

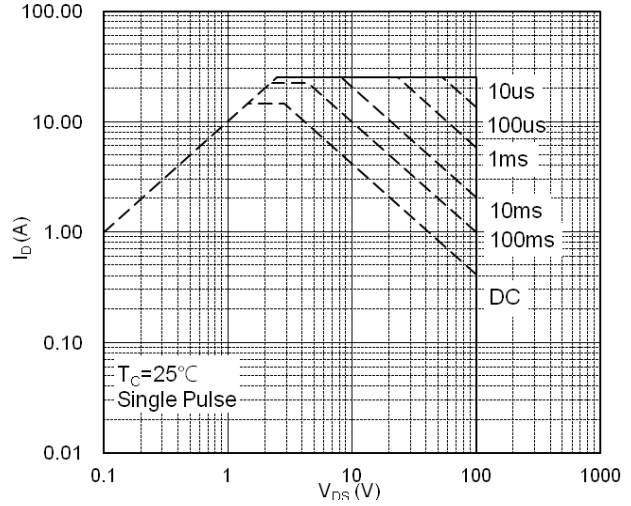

Fig.8 Safe Operating Area

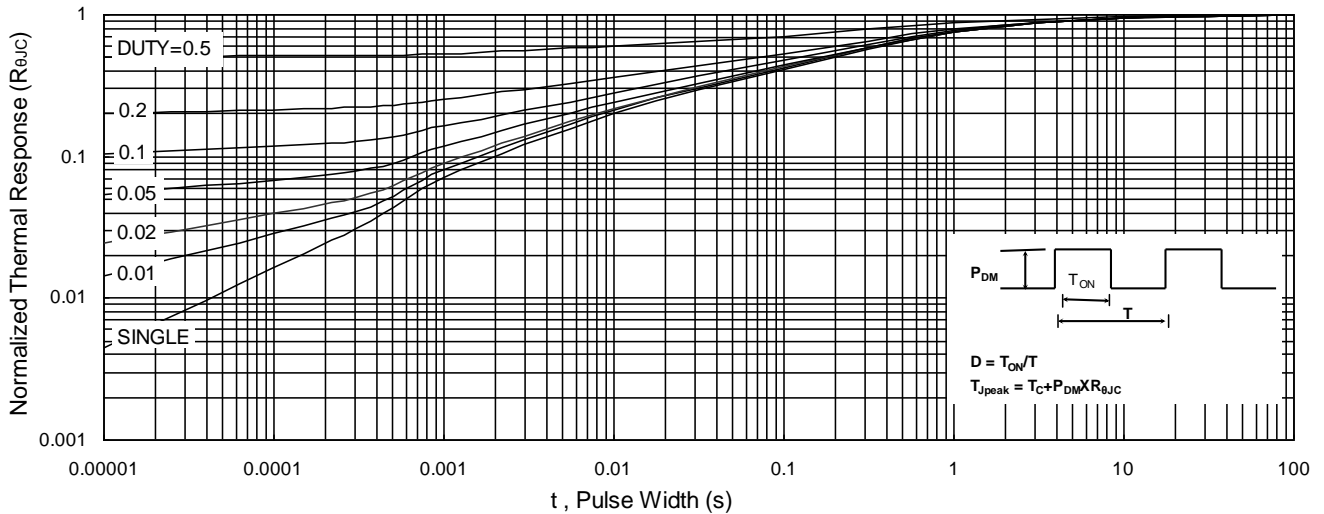
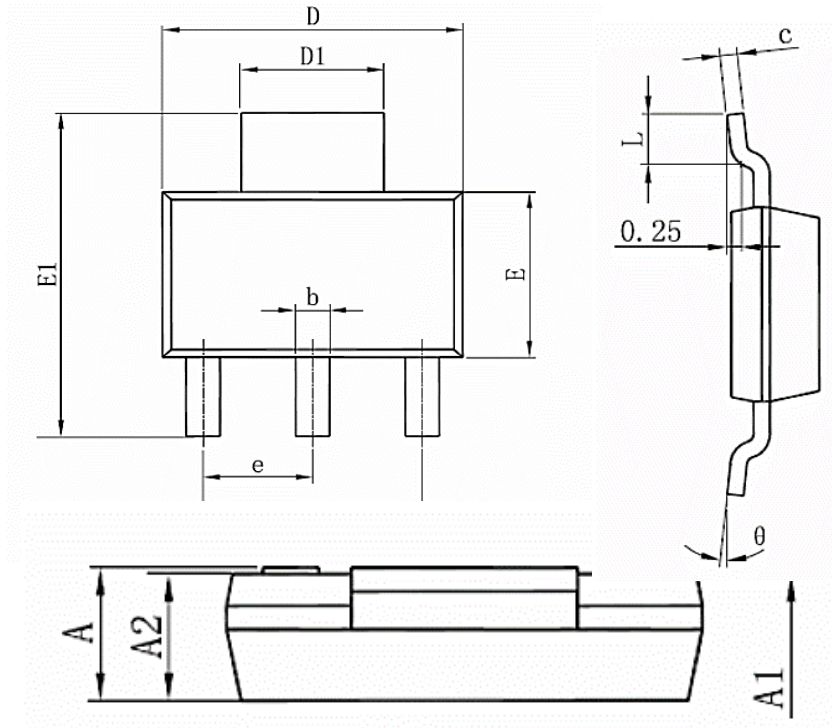

Fig.9 Normalized Maximum Transient Thermal Impedance

Package Mechanical Data:SOT-223-3L



Symbol	Dimensions In Millimeters		Dimensions In Inches	
	Min.	Max.	Min.	Max.
A	1.52	1.8	0.06	0.049
A1	0.000	0.100	0.000	0.004
A2	1.5	1.7	0.059	0.045
b	0.66	0.82	0.026	0.032
c	0.25	0.35	0.010	0.014
D	6.2	6.4	0.244	0.252
D1	2.9	3.1	0.114	0.122
E	3.3	3.7	0.130	0.146
E1	6.83	7.07	0.269	0.278
e	2.300(BSC)		0.037(BSC)	
e1	4.500	4.700	0.177	0.185
L	0.900	1.15	0.035	0.045
theta	0°	10°	0°	10°

X-ON Electronics

Largest Supplier of Electrical and Electronic Components

Click to view similar products for [MOSFET](#) category:

Click to view products by [Tritech-MOS](#) manufacturer:

Other Similar products are found below :

[IRFD120](#) [JANTX2N5237](#) [BUK455-60A/B](#) [MIC4420CM-TR](#) [VN1206L](#) [NDP4060](#) [SI4482DY](#) [IPS70R2K0CEAKMA1](#) [SQD23N06-31L-GE3](#)
[TK16J60W,S1VQ\(O](#) [2SK2614\(TE16L1,Q\)](#) [DMN1017UCP3-7](#) [DMN1053UCP4-7](#) [SQJ469EP-T1-GE3](#) [NTE2384](#) [DMC2700UDMQ-7](#)
[DMN2080UCB4-7](#) [DMN61D9UWQ-13](#) [US6M2GTR](#) [DMN31D5UDJ-7](#) [DMP22D4UFO-7B](#) [DMN1006UCA6-7](#) [DMN16M9UCA6-7](#)
[STF5N65M6](#) [IRF40H233XTMA1](#) [STU5N65M6](#) [DMN6022SSD-13](#) [DMN13M9UCA6-7](#) [DMTH10H4M6SPS-13](#) [DMN2990UFB-7B](#)
[IPB80P04P405ATMA2](#) [2N7002W-G](#) [MCAC30N06Y-TP](#) [MCQ7328-TP](#) [NTMC083NP10M5L](#) [BXP7N65D](#) [BXP4N65F](#) [AOL1454G](#)
[WMJ80N60C4](#) [BXP2N20L](#) [BXP2N65D](#) [BXT1150N10J](#) [BXT1700P06M](#) [TSM60NB380CP](#) [ROG](#) [RQ7L055BGTGR](#) [DMNH15H110SK3-13](#)
[SLF10N65ABV2](#) [BSO203SP](#) [BSO211P](#) [IPA60R230P6](#)