

**General Description**

- Low  $R_{DS(ON)}$
- RoHS and Halogen-Free Compliant

**Applications**

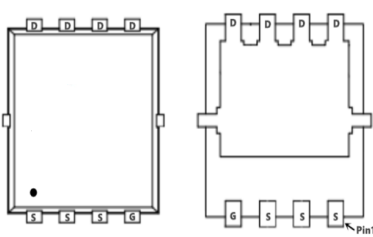
- Load switch
- PWM

**General Features**

$V_{DS} = 20V$   $I_D = 40A$

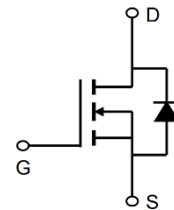
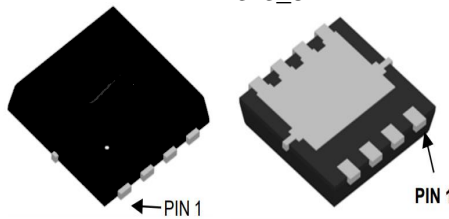
$R_{DS(ON)} = 6.3m\Omega$ (typ.) @  $V_{GS} = 10V$

- 100% UIS Tested
- 100%  $R_g$  Tested



Marking:40N02

DF:DFN3x3\_8L



**Absolute Maximum Ratings** ( $T_A=25^\circ C$  Unless Otherwise Noted)

Symbol	Parameter	Rating	Units
$V_{DS}$	Drain-Source Voltage	20	V
$V_{GS}$	Gate-Source Voltage	$\pm 20$	V
$I_D@T_C=25^\circ C$	Continuous Drain Current, $V_{GS} @ 10V^1$	40	A
$I_D@T_C=100^\circ C$	Continuous Drain Current, $V_{GS} @ 10V^1$	23	A
$I_{DM}$	Pulsed Drain Current <sup>2</sup>	210	A
EAS	Single Pulse Avalanche Energy <sup>3</sup>	36	mJ
$I_{AS}$	Avalanche Current	21	A
$P_D@T_C=25^\circ C$	Total Power Dissipation <sup>4</sup>	15	W
$T_{STG}$	Storage Temperature Range	-55 to 150	$^\circ C$
$T_J$	Operating Junction Temperature Range	-55 to 150	$^\circ C$

**Thermal Data**

Symbol	Parameter	Typ.	Max.	Unit
$R_{\theta JC}$	Thermal Resistance Junction-Case <sup>1</sup>	---	4.8	$^\circ C/W$

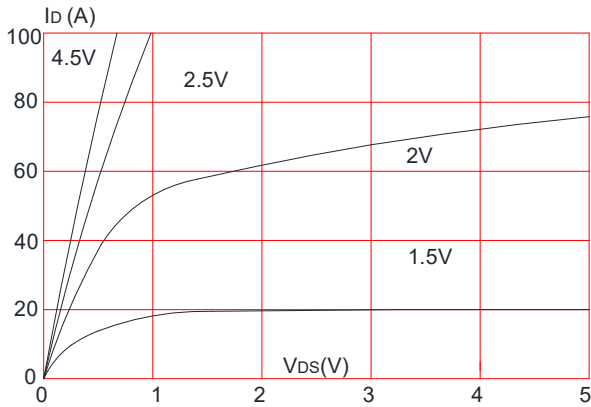
**Electrical Characteristics** ( $T_J=25^{\circ}\text{C}$  unless otherwise specified)

Symbol	Parameter	Test Condition	Min.	Typ.	Max.	Units
<b>Off Characteristic</b>						
$V_{(BR)DSS}$	Drain-Source Breakdown Voltage	$V_{GS}=0V, I_D=250\mu A$	20	-	-	V
$I_{DSS}$	Zero Gate Voltage Drain Current	$V_{DS}=20V, V_{GS}=0V,$	-	-	1.0	$\mu A$
$I_{GSS}$	Gate to Body Leakage Current	$V_{DS}=0V, V_{GS}=\pm 12V$	-	-	$\pm 100$	nA
<b>On Characteristics</b>						
$V_{GS(th)}$	Gate Threshold Voltage	$V_{DS}=V_{GS}, I_D=250\mu A$	0.4	0.7	1.1	V
$R_{DS(on)}$	Static Drain-Source on-Resistance note3	$V_{GS}=4.5V, I_D=25A$	-	6.3	8.0	m $\Omega$
		$V_{GS}=2.5V, I_D=10A$	-	8.8	13	
<b>Dynamic Characteristics</b>						
$C_{iss}$	Input Capacitance	$V_{DS}=10V, V_{GS}=0V,$ $f=1.0MHz$	-	1458	-	pF
$C_{oss}$	Output Capacitance		-	238	-	pF
$C_{rss}$	Reverse Transfer Capacitance		-	212	-	pF
$Q_g$	Total Gate Charge	$V_{DS}=10V, I_D=25A,$ $V_{GS}=4.5V$	-	19	-	nC
$Q_{gs}$	Gate-Source Charge		-	3	-	nC
$Q_{gd}$	Gate-Drain("Miller") Charge		-	6.4	-	nC
<b>Switching Characteristics</b>						
$t_{d(on)}$	Turn-on Delay Time	$V_{DS}=10V,$ $I_D=10A, R_{GEN}=3\Omega,$ $V_{GS}=4.5V$	-	10	-	ns
$t_r$	Turn-on Rise Time		-	21	-	ns
$t_{d(off)}$	Turn-off Delay Time		-	39	-	ns
$t_f$	Turn-off Fall Time		-	19	-	ns
<b>Drain-Source Diode Characteristics and Maximum Ratings</b>						
$I_S$	Maximum Continuous Drain to Source Diode Forward Current		-	-	40	A
$I_{SM}$	Maximum Pulsed Drain to Source Diode Forward Current		-	-	200	A
$V_{SD}$	Drain to Source Diode Forward Voltage	$V_{GS}=0V, I_S=30A$	-	-	1.2	V
$t_{rr}$	Body Diode Reverse Recovery Time	$I_F=20A, di/dt=100A/\mu s$	-	25	-	ns
$Q_{rr}$	Body Diode Reverse Recovery Charge		-	20	-	nC

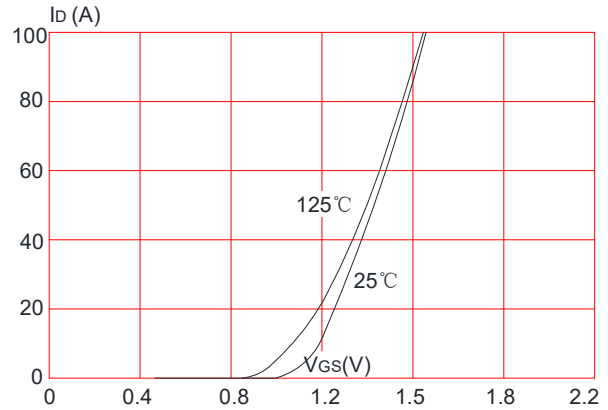
- Notes: 1. Repetitive Rating: Pulse Width Limited by Maximum Junction Temperature  
 2. EAS condition:  $T_J=25^{\circ}\text{C}, V_{DD}=10V, V_G=4.5V, L=0.5mH, R_G=25\Omega, I_{AS}=12A$   
 3. Pulse Test: Pulse Width $\leq 300\mu s$ , Duty Cycle $\leq 0.5\%$

## Typical Performance Characteristics

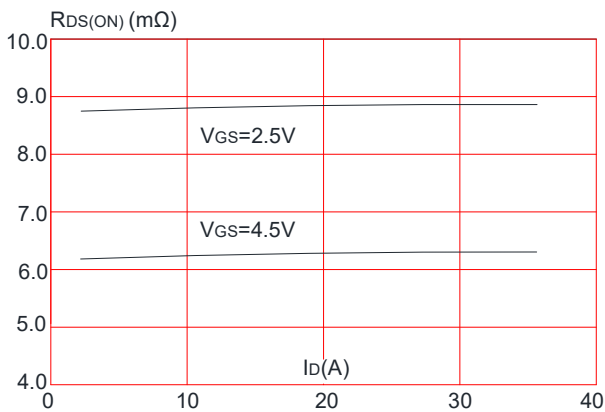
**Figure 1: Output Characteristics**



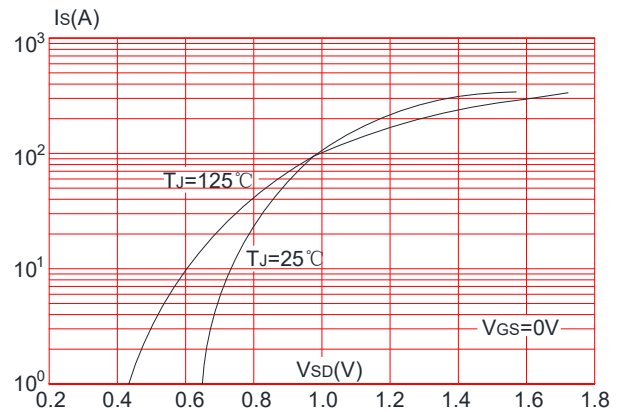
**Figure 2: Typical Transfer Characteristics**



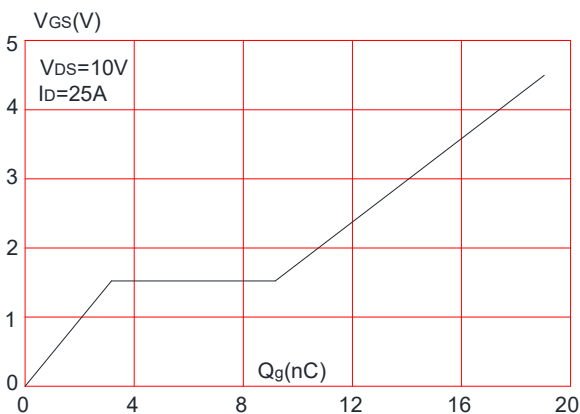
**Figure 3: On-resistance vs. Drain Current**



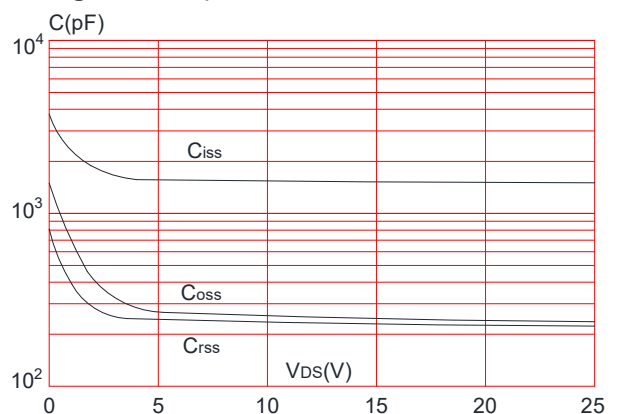
**Figure 4: Body Diode Characteristics**



**Figure 5: Gate Charge Characteristics**

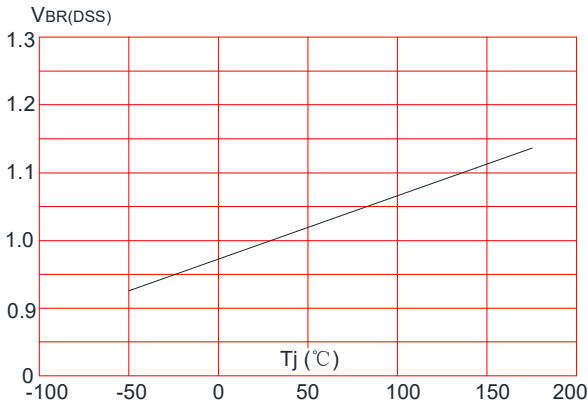


**Figure 6: Capacitance Characteristics**

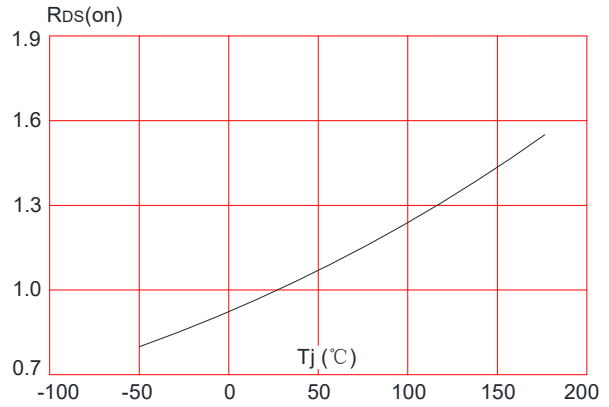


**N-Channel Enhancement Mosfet**

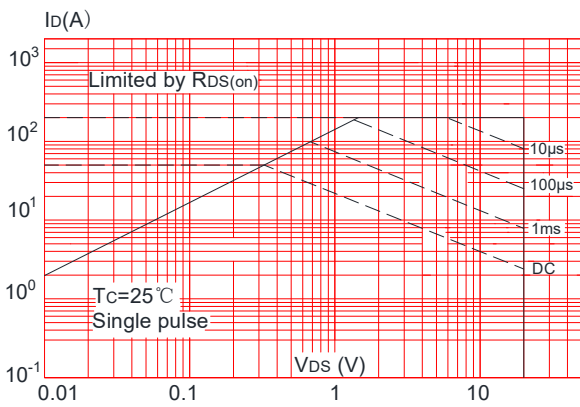
**Figure 7:** Normalized Breakdown Voltage vs. Junction Temperature



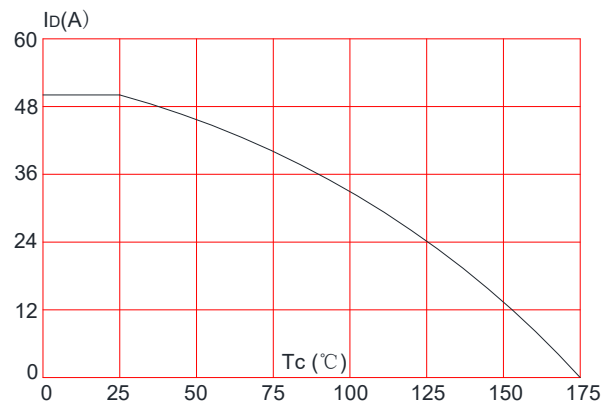
**Figure 8:** Normalized on Resistance vs. Junction Temperature



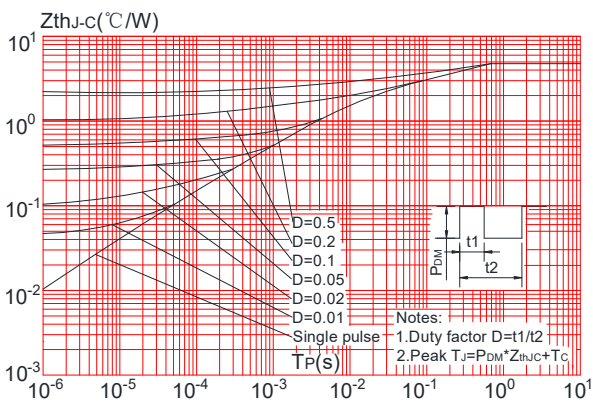
**Figure 9:** Maximum Safe Operating Area



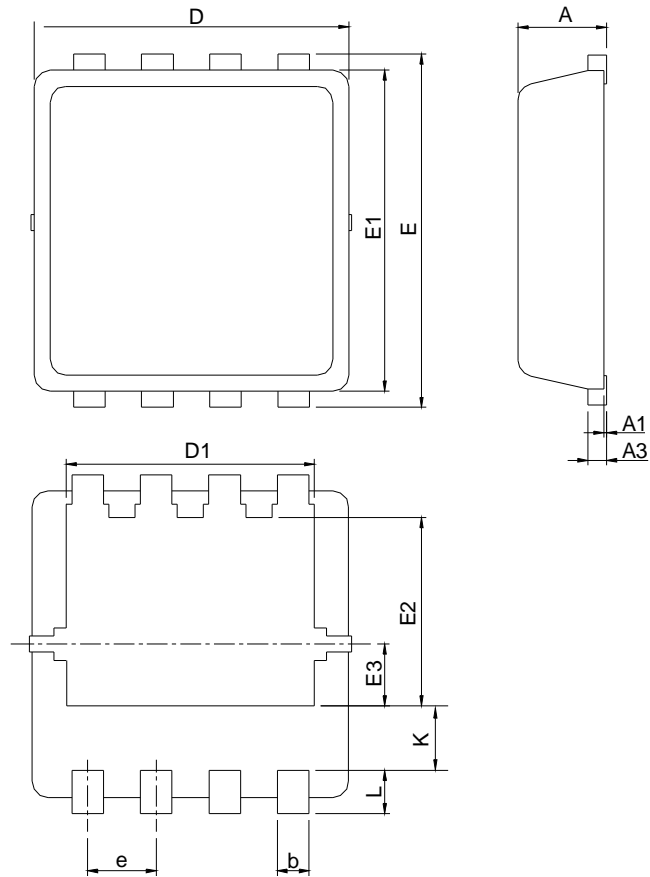
**Figure 10:** Maximum Continuous Drain Current vs. Case Temperature



**Figure.11:** Maximum Effective Transient Thermal Impedance, Junction-to-Case

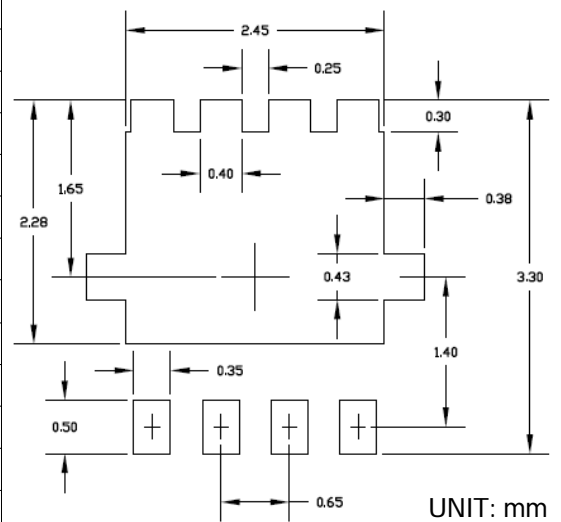


# Package Information:DFN3x3\_8L



SYMBOL	DFN3x3-8			
	MILLIMETERS		INCHES	
	MIN.	MAX.	MIN.	MAX.
A	0.80	1.00	0.031	0.039
A1	0.00	0.05	0.000	0.002
A3	0.10	0.25	0.004	0.010
b	0.24	0.35	0.009	0.014
D	2.90	3.10	0.114	0.122
D1	2.25	2.45	0.089	0.096
E	3.10	3.30	0.122	0.130
E1	2.90	3.10	0.114	0.122
E2	1.65	1.85	0.065	0.073
E3	0.56	0.58	0.022	0.023
e	0.65 BSC		0.026 BSC	
K	0.475	0.775	0.019	0.031
L	0.30	0.50	0.012	0.020

## RECOMMENDED LAND PATTERN



## X-ON Electronics

Largest Supplier of Electrical and Electronic Components

*Click to view similar products for [MOSFET](#) category:*

*Click to view products by [Tritech-MOS](#) manufacturer:*

Other Similar products are found below :

[IRFD120](#) [JANTX2N5237](#) [BUK455-60A/B](#) [MIC4420CM-TR](#) [VN1206L](#) [NDP4060](#) [SI4482DY](#) [IPS70R2K0CEAKMA1](#) [SQD23N06-31L-GE3](#)  
[TK16J60W,S1VQ\(O](#) [2SK2614\(TE16L1,Q\)](#) [DMN1017UCP3-7](#) [DMN1053UCP4-7](#) [SQJ469EP-T1-GE3](#) [NTE2384](#) [DMC2700UDMQ-7](#)  
[DMN2080UCB4-7](#) [DMN61D9UWQ-13](#) [US6M2GTR](#) [DMN31D5UDJ-7](#) [DMP22D4UFO-7B](#) [DMN1006UCA6-7](#) [DMN16M9UCA6-7](#)  
[STF5N65M6](#) [IRF40H233XTMA1](#) [STU5N65M6](#) [DMN6022SSD-13](#) [DMN13M9UCA6-7](#) [DMTH10H4M6SPS-13](#) [DMN2990UFB-7B](#)  
[IPB80P04P405ATMA2](#) [2N7002W-G](#) [MCAC30N06Y-TP](#) [MCQ7328-TP](#) [BXP7N65D](#) [BXP4N65F](#) [AOL1454G](#) [WMJ80N60C4](#) [BXP2N20L](#)  
[BXP2N65D](#) [BXT1150N10J](#) [BXT1700P06M](#) [TSM60NB380CP](#) [ROG](#) [RQ7L055BGTCR](#) [DMNH15H110SK3-13](#) [SLF10N65ABV2](#)  
[BSO203SP](#) [BSO211P](#) [IPA60R230P6](#) [IPA60R460CE](#)