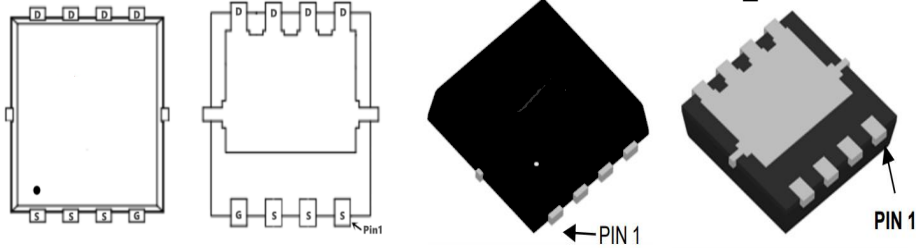
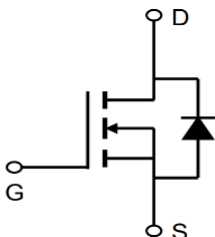

TMN3023DF

N-Channel Enhancement Mosfet

<p>General Description</p> <ul style="list-style-type: none"> • Low $R_{DS(ON)}$ • RoHS and Halogen-Free Compliant <p>Applications</p> <ul style="list-style-type: none"> • Load switch • PWM 	<p>General Features</p> <p>$V_{DS} = 30V$ $I_D = 23A$</p> <p>$R_{DS(ON)} = 16 m\Omega$ (typ. .) @ $V_{GS}=10V$</p> <p>100% UIS Tested 100% R_g Tested</p> 
--	--

DF:DFN3x3_8L

Marking: 23N03 OR 7410

Absolute Maximum Ratings ($T_A = 25^\circ C$ Unless Otherwise Noted)

Symbol	Parameter	Rating	Unit	
V_{DSS}	Drain-Source Voltage	30	V	
V_{GSS}	Gate-Source Voltage	± 20		
I_D^a	Continuous Drain Current ($V_{GS}=10V$)	$T_A=25^\circ C$	7	A
		$T_A=70^\circ C$	5.6	
I_{DM}^a	Pulsed Drain Current ($V_{GS}=10V$)	28		
I_D^c	Continuous Drain Current ($V_{GS}=10V$)	$T_C=25^\circ C$	23	
		$T_C=70^\circ C$	19	
I_S^a	Diode Continuous Forward Current	1.5		
I_{AS}^b	Avalanche Current, Single pulse	$L=0.1mH$	13	
		$L=0.5mH$	7	
E_{AS}^b	Avalanche Energy, Single pulse	$L=0.1mH$	8.45	mJ
		$L=0.5mH$	12.25	
T_J	Maximum Junction Temperature	150	$^\circ C$	
T_{STG}	Storage Temperature Range	-55 to 150		
P_D^a	Maximum Power Dissipation	$T_A=25^\circ C$	1.56	W
		$T_A=70^\circ C$	1	
P_D^c	Maximum Power Dissipation	$T_C=25^\circ C$	17.8	
		$T_C=70^\circ C$	11.4	
$R_{\theta JA}^a$	Thermal Resistance-Junction to Ambient	$t \leq 10s$	50	$^\circ C/W$
		Steady State	80	
$R_{\theta JC}^c$	Thermal Resistance-Junction to Case	Steady State	7	

Note a : Surface Mounted on $1in^2$ pad area, $t \leq 10sec.$
 b : UIS tested and pulse width limited by maximum junction temperature $150^\circ C$ (initial temperature $T_J=25^\circ C$).
 c : The power dissipation P_D is based on $T_{J(MAX)} = 150^\circ C$, and it is useful for reducing junction-to-case thermal resistance ($R_{\theta JC}$) when additional heat sink is used.

Electrical Characteristics ($T_J=25^\circ\text{C}$ unless otherwise specified)

Symbol	Parameter	Test Conditions	Min.	Typ.	Max.	Unit
Static Characteristics						
BV_{DSS}	Drain-Source Breakdown Voltage	$V_{GS}=0V, I_{DS}=250\mu A$	30	-	-	V
I_{DSS}	Zero Gate Voltage Drain Current	$V_{DS}=24V, V_{GS}=0V$ $T_J=85^\circ\text{C}$	-	-	1	μA
			-	-	30	
$V_{GS(th)}$	Gate Threshold Voltage	$V_{DS}=V_{GS}, I_{DS}=250\mu A$	1.0	1.8	2.5	V
I_{GSS}	Gate Leakage Current	$V_{GS}=\pm 20V, V_{DS}=0V$	-	-	± 100	nA
$R_{DS(ON)}^d$	Drain-Source On-state Resistance	$V_{GS}=10V, I_{DS}=8A$ $T_J=125^\circ\text{C}$	-	16	21	m Ω
		$V_{GS}=4.5V, I_{DS}=5A$	-	21	26	
Diode Characteristics						
V_{SD}^d	Diode Forward Voltage	$I_{SD}=1A, V_{GS}=0V$	-	0.75	1.1	V
t_{rr}^e	Reverse Recovery Time	$I_{SD}=8A, dI_{SD}/dt=100A/\mu s$	-	12	-	ns
t_a	Charge Time		-	6.2	-	
t_b	Discharge Time		-	5.8	-	
Q_{rr}^e	Reverse Recovery Charge		-	3.7	-	
Dynamic Characteristics^e						
R_G	Gate Resistance	$V_{GS}=0V, V_{DS}=0V, F=1\text{MHz}$	1	1.5	3	Ω
C_{iss}	Input Capacitance	$V_{GS}=0V,$ $V_{DS}=15V,$ Frequency=1.0MHz	300	415	550	pF
C_{oss}	Output Capacitance		50	70	100	
C_{rss}	Reverse Transfer Capacitance		30	40	60	
$t_{d(ON)}$	Turn-on Delay Time	$V_{DD}=15V, R_L=15\Omega,$ $I_{DS}=1A, V_{GEN}=10V,$ $R_G=6\Omega$	-	5.5	9	ns
t_r	Turn-on Rise Time		-	9	18	
$t_{d(OFF)}$	Turn-off Delay Time		-	14	25	
t_f	Turn-off Fall Time		-	3.6	7	
Gate Charge Characteristics^e						
Q_g	Total Gate Charge	$V_{DS}=15V, V_{GS}=4.5V,$ $I_{DS}=8A$	-	3.8	5.5	nC
Q_g	Total Gate Charge	$V_{DS}=15V, V_{GS}=10V,$ $I_{DS}=8A$	-	8	13	
Q_{gth}	Threshold Gate Charge		-	0.4	0.7	
Q_{gs}	Gate-Source Charge		-	1.1	1.8	
Q_{gd}	Gate-Drain Charge		-	1.6	2.1	

Note d : Pulse test ; pulse width $\leq 300 \mu s$, duty cycle $\leq 2\%$.

Note e : Guaranteed by design, not subject to production testing.

Typical Operating Characteristics

Power Dissipation

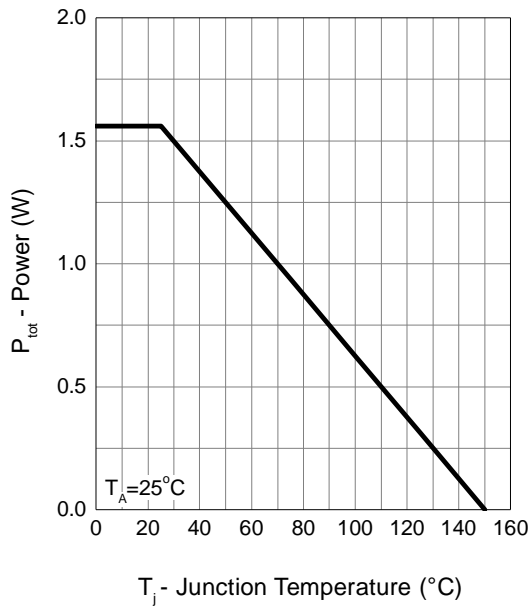

Drain Current

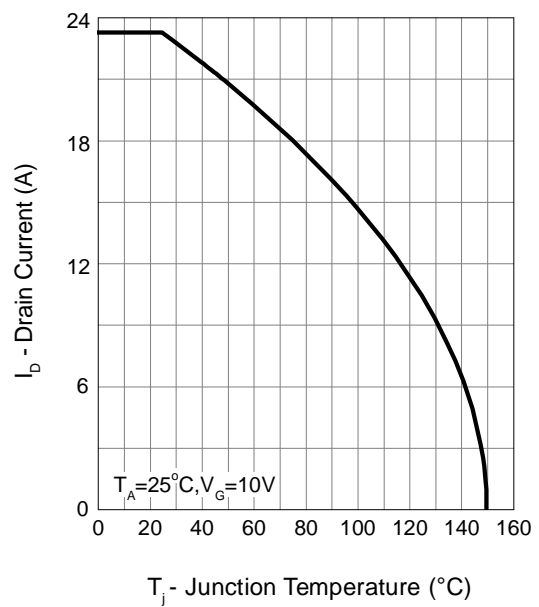

Safe Operation Area

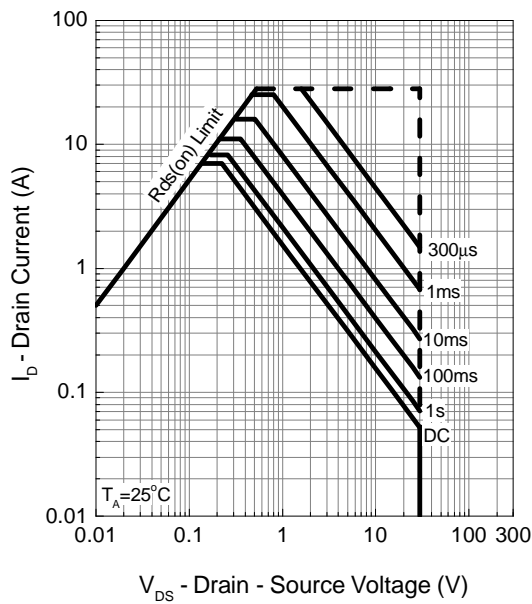

Thermal Transient Impedance

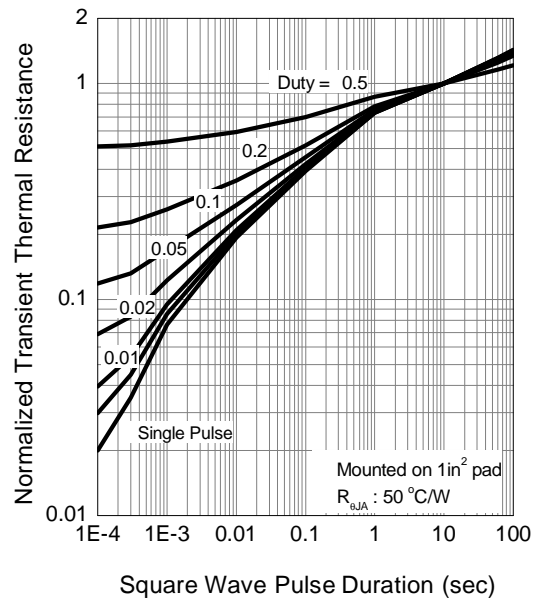



TMN3023DF

N-Channel Enhancement Mosfet

Power Dissipation

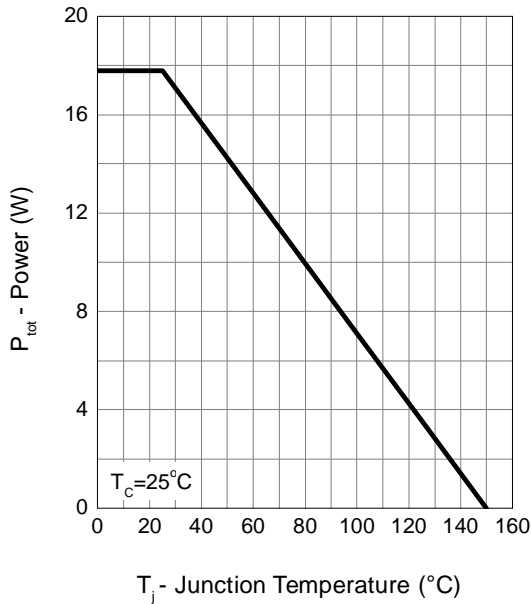

Drain Current

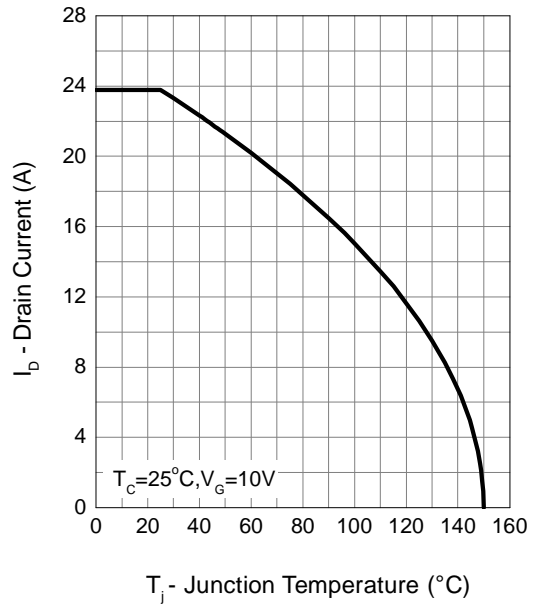

Safe Operation Area

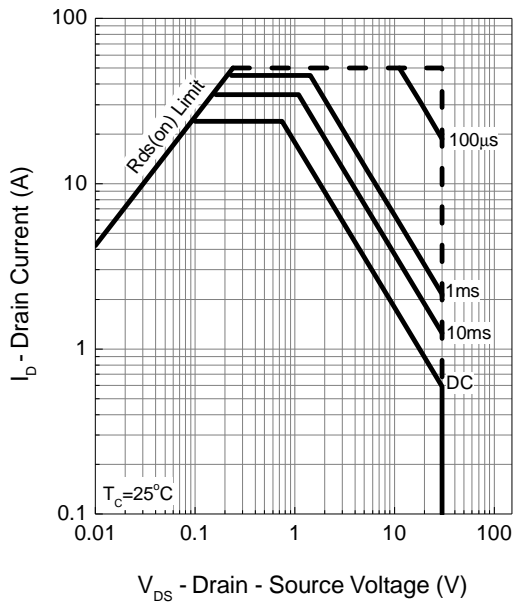

Thermal Transient Impedance

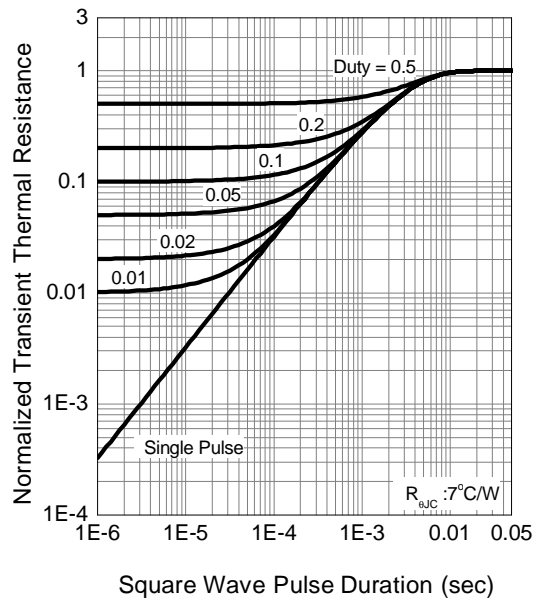

TMN3023DF

N-Channel Enhancement Mosfet

Output Characteristics

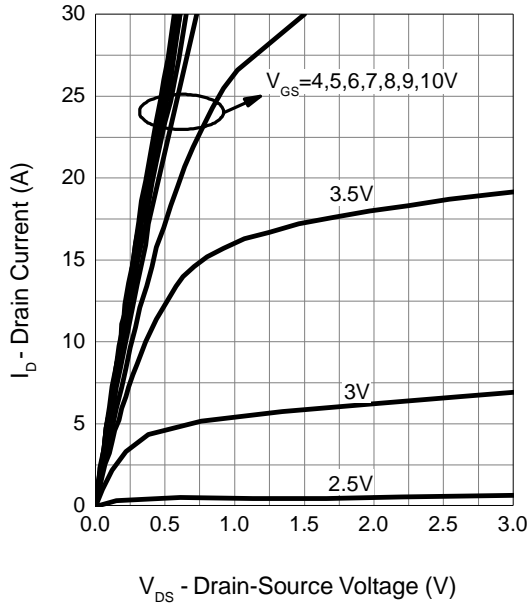

Drain-Source On Resistance

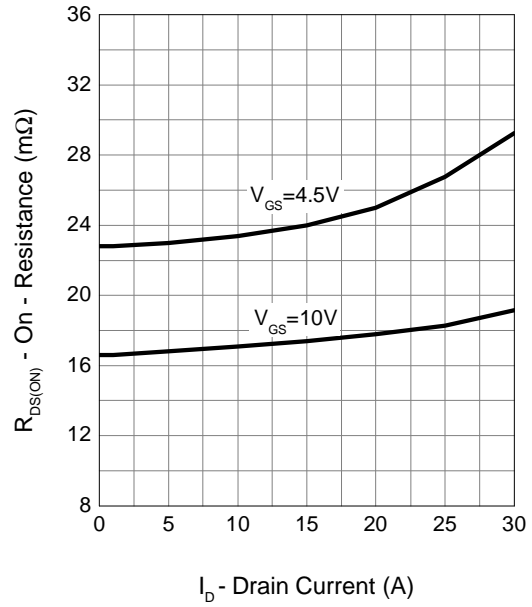

Gate-Source On Resistance

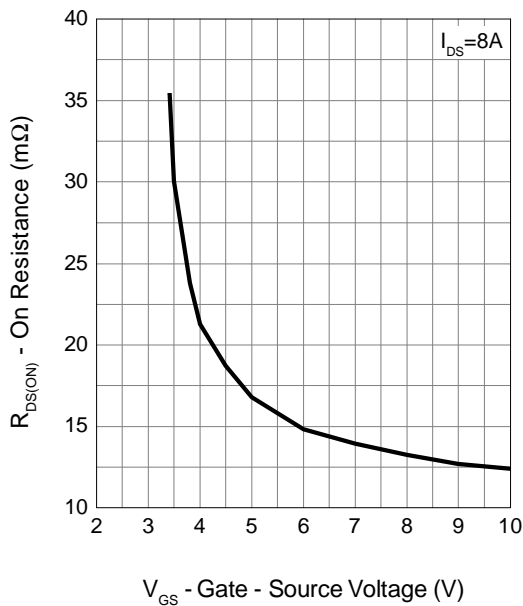

Gate Threshold Voltage

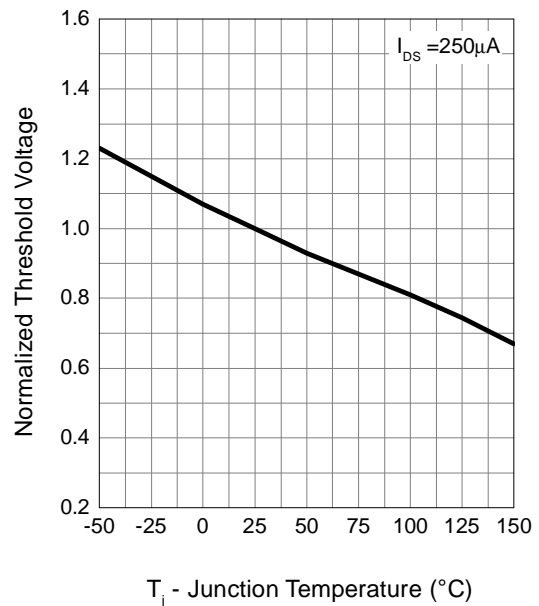

TMN3023DF

N-Channel Enhancement Mosfet

Drain-Source On Resistance

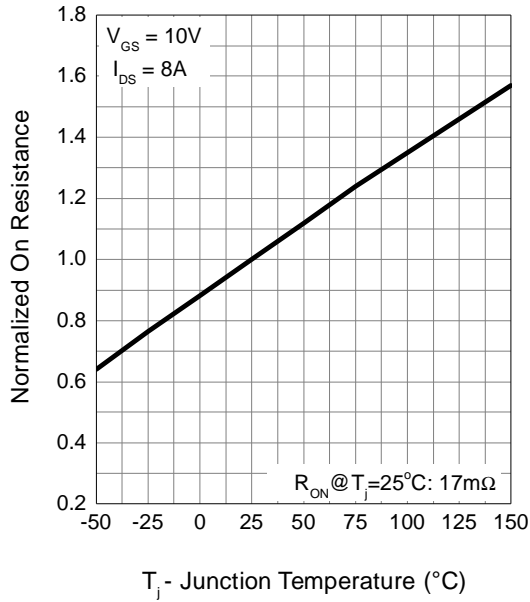

Source-Drain Diode Forward

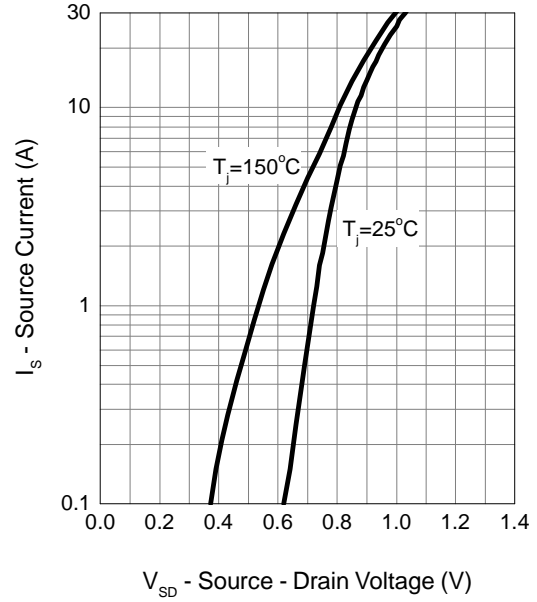

Capacitance

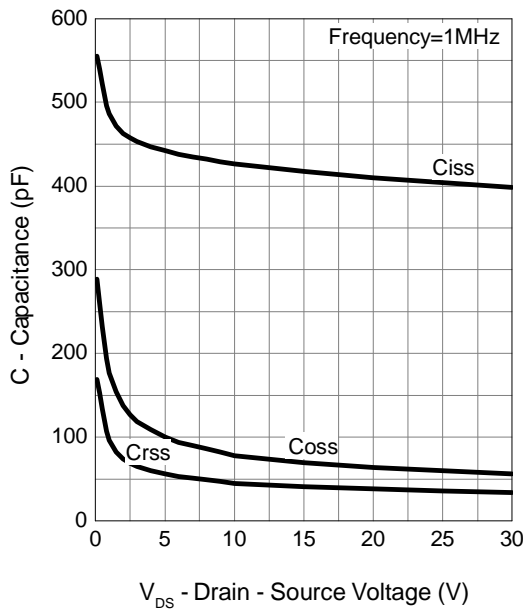

Gate Charge

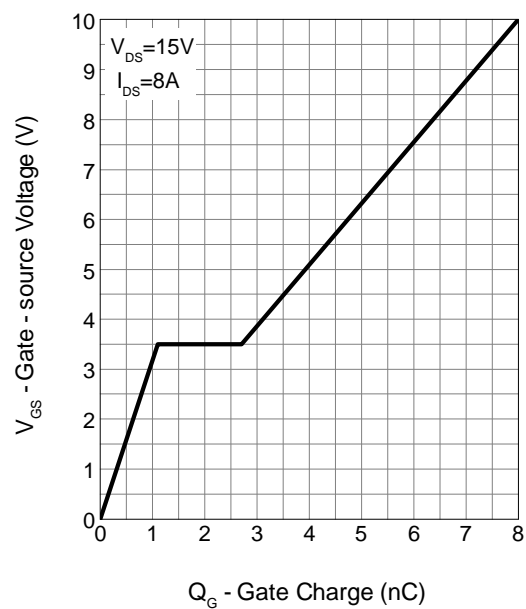

Transfer Characteristics

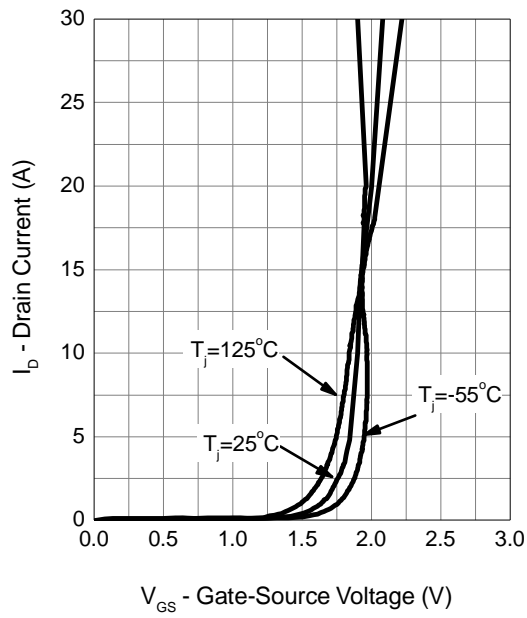

Avalanche Test Circuit and Waveforms

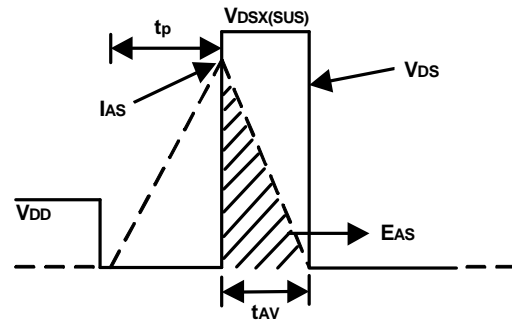
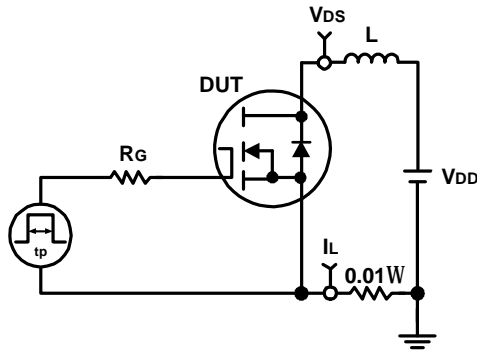

Switching Time Test Circuit and Waveforms

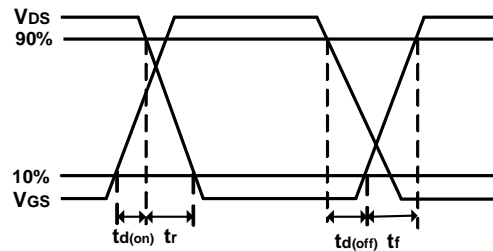
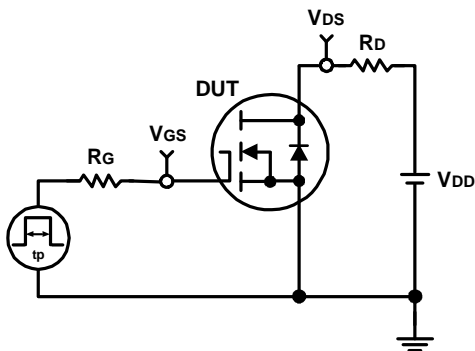

Package Mechanical Data:DFN3x3-8L

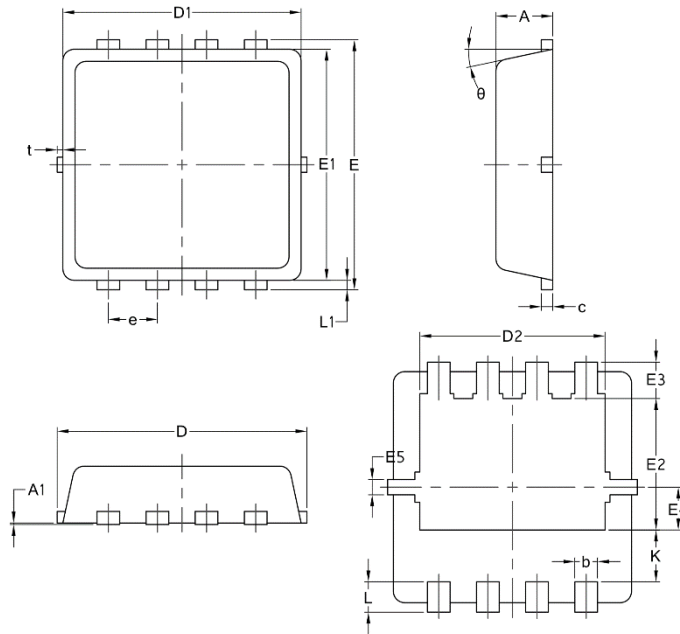

Symbol	Common		
	mm		
	Mim	Nom	Max
A	0.70	0.75	0.85
A1	/	/	0.05
b	0.20	0.30	0.40
c	0.10	0.152	0.25
D	3.15	3.30	3.45
D1	3.00	3.15	3.25
D2	2.29	2.45	2.65
E	3.15	3.30	3.45
E1	2.90	3.05	3.20
E2	1.54	1.74	1.94
E3	0.28	0.48	0.65
E4	0.37	0.57	0.77
E5	0.10	0.20	0.30
e	0.60	0.65	0.70
K	0.59	0.69	0.89
L	0.30	0.40	0.50
L1	0.06	0.125	0.20
t	0	0.075	0.13
Φ	10	12	14

X-ON Electronics

Largest Supplier of Electrical and Electronic Components

Click to view similar products for [MOSFET](#) category:

Click to view products by [Tritech-MOS](#) manufacturer:

Other Similar products are found below :

[IRFD120](#) [JANTX2N5237](#) [BUK455-60A/B](#) [MIC4420CM-TR](#) [VN1206L](#) [NDP4060](#) [SI4482DY](#) [IPS70R2K0CEAKMA1](#) [SQD23N06-31L-GE3](#)
[TK16J60W,S1VQ\(O](#) [2SK2614\(TE16L1,Q\)](#) [DMN1017UCP3-7](#) [DMN1053UCP4-7](#) [SQJ469EP-T1-GE3](#) [NTE2384](#) [DMC2700UDMQ-7](#)
[DMN2080UCB4-7](#) [DMN61D9UWQ-13](#) [US6M2GTR](#) [DMN31D5UDJ-7](#) [DMP22D4UFO-7B](#) [DMN1006UCA6-7](#) [DMN16M9UCA6-7](#)
[STF5N65M6](#) [IRF40H233XTMA1](#) [STU5N65M6](#) [DMN6022SSD-13](#) [DMN13M9UCA6-7](#) [DMTH10H4M6SPS-13](#) [DMN2990UFB-7B](#)
[IPB80P04P405ATMA2](#) [2N7002W-G](#) [MCAC30N06Y-TP](#) [MCQ7328-TP](#) [NTMC083NP10M5L](#) [BXP7N65D](#) [BXP4N65F](#) [AOL1454G](#)
[WMJ80N60C4](#) [BXP2N20L](#) [BXP2N65D](#) [BXT1150N10J](#) [BXT1700P06M](#) [TSM60NB380CP](#) [ROG](#) [RQ7L055BGTGR](#) [DMNH15H110SK3-13](#)
[SLF10N65ABV2](#) [BSO203SP](#) [BSO211P](#) [IPA60R230P6](#)