

**TMP2050AD**

**P -Channel Enhancement Mosfet**

<p><b>General Description</b></p> <ul style="list-style-type: none"> <li>• Low <math>R_{DS(ON)}</math></li> <li>• RoHS and Halogen-Free Compliant</li> </ul> <p><b>Applications</b></p> <ul style="list-style-type: none"> <li>• Load switch</li> <li>• PWM</li> </ul>	<p><b>General Features</b></p> <p><math>V_{DS} = -20V</math> <math>I_D = -48A</math></p> <p><math>R_{DS(ON)} = 13m\Omega</math> (typ.) @ <math>V_{GS} = -4.5V</math></p> <p>100% UIS Tested 100% <math>R_g</math> Tested</p> 
--	--

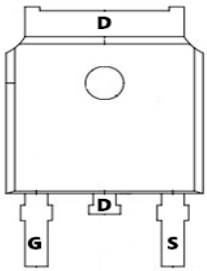

**D:TO-252-3L**

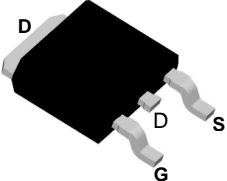
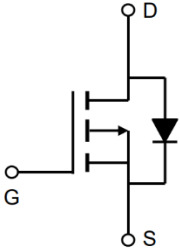
Marking: 50P02

**Absolute Maximum Ratings (TC=25°C unless otherwise noted)**

Symbol	Parameter	Rating	Unit	
$V_{DSS}$	Drain-Source Voltage	-20	V	
$V_{GSS}$	Gate-Source Voltage	±12		
$I_D^a$	Continuous Drain Current ( $V_{GS} = -4.5V$ )	$T_A = 25^\circ C$	-48	A
		$T_A = 70^\circ C$	-36	
$I_{DM}^a$	Pulsed Drain Current ( $V_{GS} = -4.5V$ )	-44		
$I_D^c$	Continuous Drain Current	$T_C = 25^\circ C$	-35	
		$T_C = 100^\circ C$	-22	
$I_S^a$	Diode Continuous Forward Current	-10		
$T_J$	Maximum Junction Temperature	150	°C	
$I_{AS}^d$	Avalanche Current, Single pulse	L=0.5mH	-12	A
$E_{AS}^d$	Avalanche Energy, Single pulse	L=0.5mH	36	mJ
$T_{STG}$	Storage Temperature Range	-55 to 150	°C	
$P_D^a$	Maximum Power Dissipation	$T_A = 25^\circ C$	3.1	W
		$T_A = 70^\circ C$	2	
$P_D^c$	Maximum Power Dissipation	$T_C = 25^\circ C$	31.25	
		$T_C = 100^\circ C$	12.5	
$R_{\theta JA}^{a,b}$	Thermal Resistance-Junction to Ambient	t ≤ 10s	40	°C/W
		Steady State	80	
$R_{\theta JC}^c$	Thermal Resistance-Junction to Case	4	°C/W	

Note \* : Package limited.

a : Surface Mounted on 1in<sup>2</sup> pad area, t ≤ 10sec.

b : Maximum under Steady State conditions is 75 °C/W.

c : The power dissipation  $P_D$  is based on  $T_{J(MAX)} = 150^\circ C$ , and it is useful for reducing junction-to-case thermal resistance ( $R_{\theta JC}$ ) when additional heat sink is used.

d : UIS tested and pulse width limited by maximum junction temperature 150oC (initial temperature  $T_J = 25oC$ )

**Electrical Characteristics** ( $T_A = 25^\circ\text{C}$  Unless Otherwise Noted)

Symbol	Parameter	Test Conditions	Min.	Typ.	Max.	Unit
<b>Static Characteristics</b>						
$BV_{DSS}$	Drain-Source Breakdown Voltage	$V_{GS}=0V, I_{DS}=-250\mu A$	-20	-	-	V
$I_{DSS}$	Zero Gate Voltage Drain Current	$V_{DS}=-16V, V_{GS}=0V$	-	-	-1	$\mu A$
		$T_J=85^\circ C$	-	-	-30	
$V_{GS(th)}$	Gate Threshold Voltage	$V_{DS}=V_{GS}, I_{DS}=-250\mu A$	-0.5	-0.7	-1	V
$I_{GSS}$	Gate Leakage Current	$V_{GS}=\pm 12V, V_{DS}=0V$	-	-	$\pm 10$	$\mu A$
$R_{DS(ON)}^e$	Drain-Source On-state Resistance	$V_{GS}=-4.5V, I_{DS}=-11A$	-	13	17	m $\Omega$
		$V_{GS}=-2.5V, I_{DS}=-6A$	-	18	25	
		$V_{GS}=-1.8V, I_{DS}=-1A$	-	26	45	
<b>Diode Characteristics</b>						
$V_{SD}^e$	Diode Forward Voltage	$I_{SD}=-1A, V_{GS}=0V$	-	-0.7	-1	V
$t_{rr}^f$	Reverse Recovery Time	$I_{SD}=-11A, di_{SD}/dt=100A/\mu s$	-	63	-	ns
$Q_{rr}^f$	Reverse Recovery Charge		-	54	-	nC
<b>Dynamic Characteristics<sup>f</sup></b>						
$C_{iss}$	Input Capacitance	$V_{GS}=0V,$ $V_{DS}=-10V,$ Frequency=1.0MHz	-	1620	-	pF
$C_{oss}$	Output Capacitance		-	320	-	
$C_{rss}$	Reverse Transfer Capacitance		-	290	-	
$t_{d(ON)}$	Turn-on Delay Time	$V_{DD}=-10V, R_L=10\Omega,$ $I_{DS}=-1A, V_{GEN}=-4.5V,$ $R_G=6\Omega$	-	9	-	ns
$t_r$	Turn-on Rise Time		-	13	-	
$t_{d(OFF)}$	Turn-off Delay Time		-	26	-	
$t_f$	Turn-off Fall Time		-	167	-	
<b>Gate Charge Characteristics<sup>f</sup></b>						
$Q_g$	Total Gate Charge	$V_{DS}=-10V, V_{GS}=-4.5V,$ $I_{DS}=-11A$	-	25	-	nC
$Q_{gs}$	Gate-Source Charge		-	1.6	-	
$Q_{gd}$	Gate-Drain Charge		-	11	-	

 Note e : Pulse test; pulse width $\leq 300\mu s$ , duty cycle $\leq 2\%$ .

Note f : Guaranteed by design, not subject to production testing.

## Typical Operating Characteristics

Power Dissipation

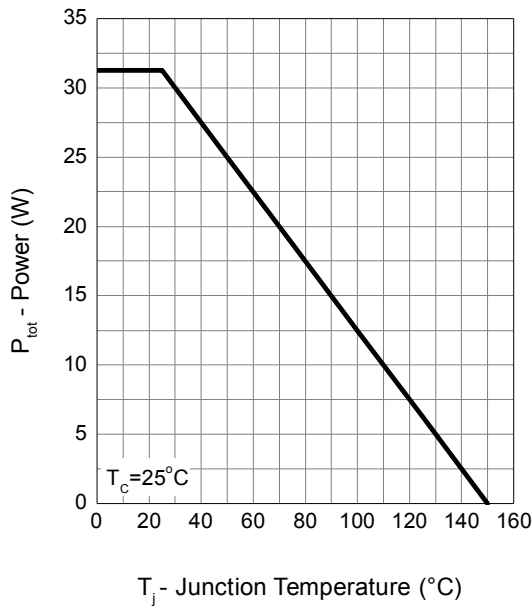

Drain Current

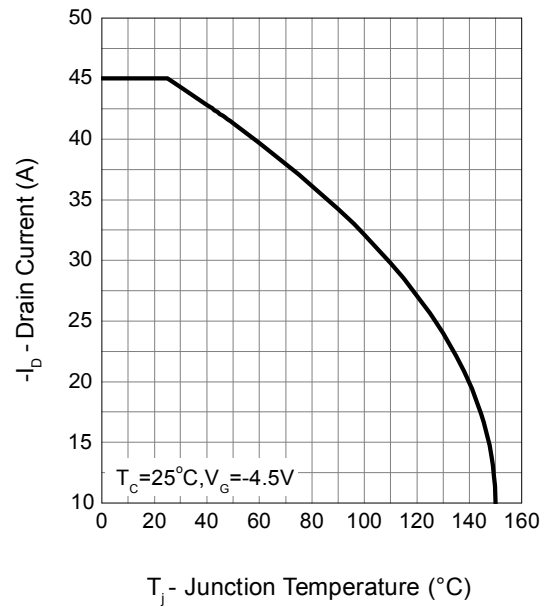

Safe Operation Area

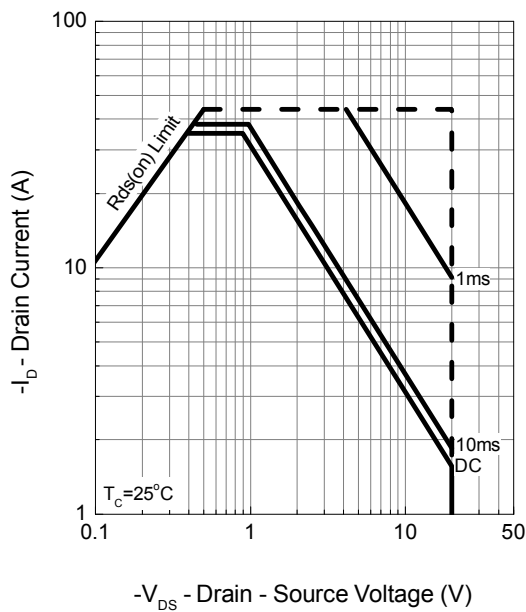

Thermal Transient Impedance

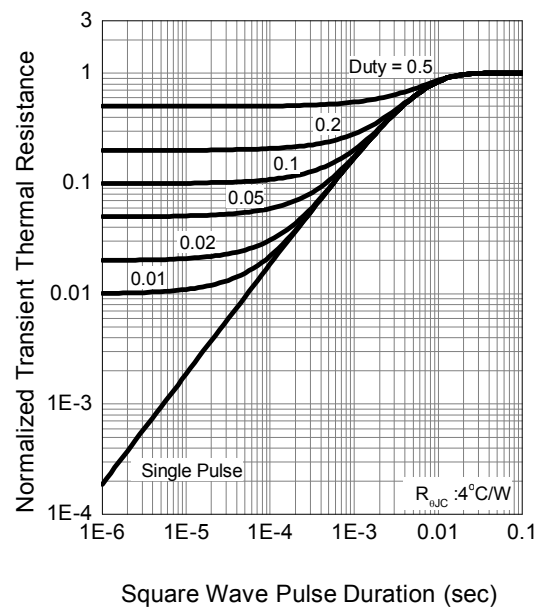



# TMP2050AD

# P -Channel Enhancement Mosfet

### Output Characteristics

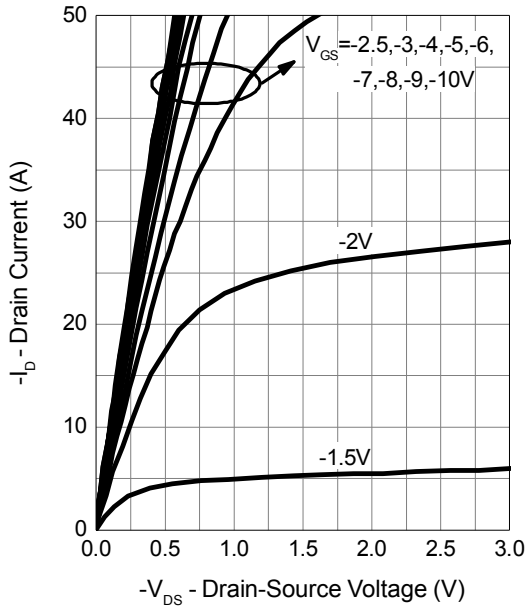

### Drain-Source On Resistance

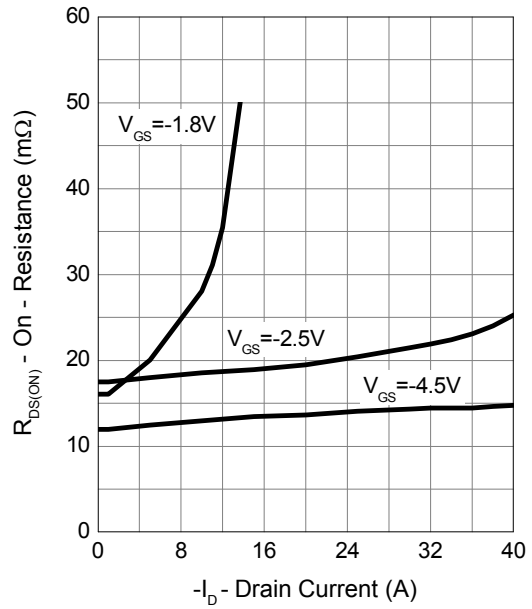

### Gate-Source On Resistance

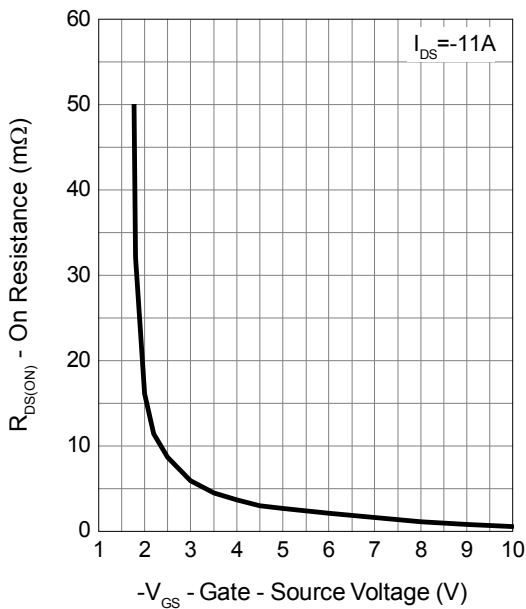

### Gate Threshold Voltage

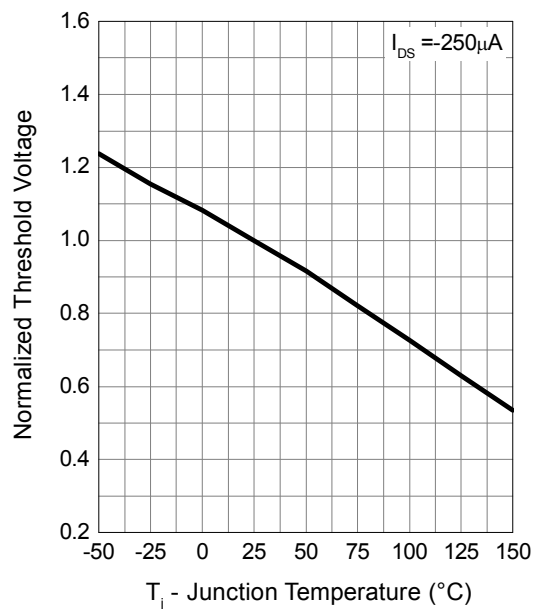



Drain-Source On Resistance

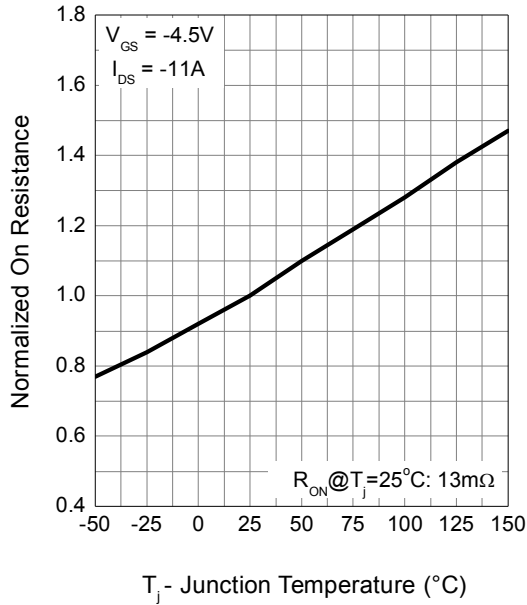

Source-Drain Diode Forward

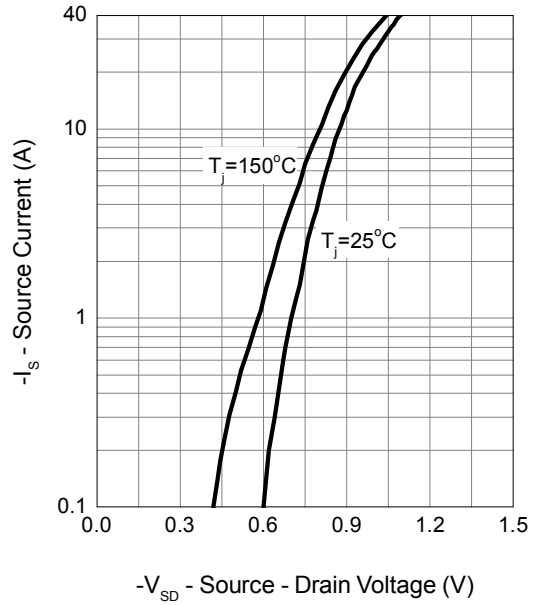

Capacitance

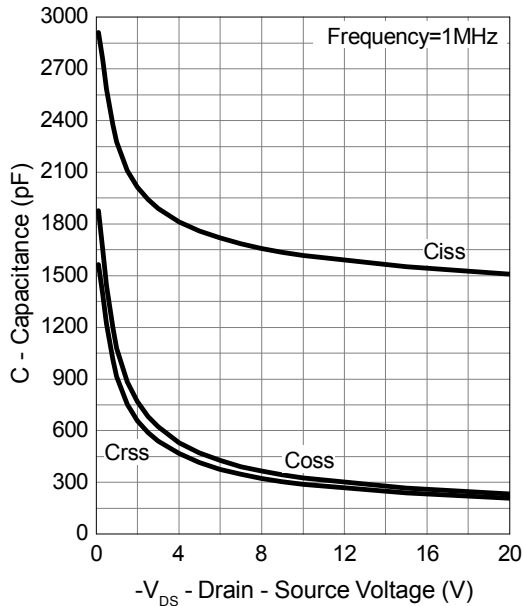

Gate Charge

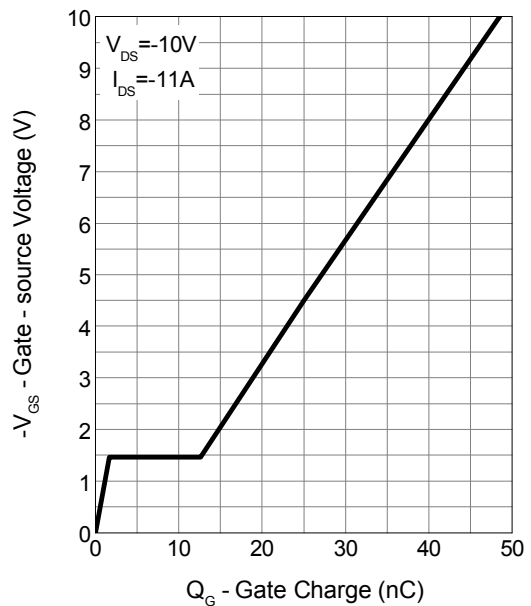

Transfer Characteristics

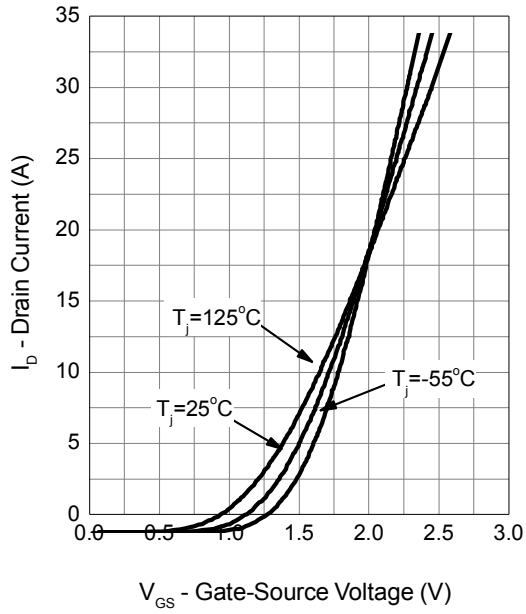



### Avalanche Test Circuit and Waveforms

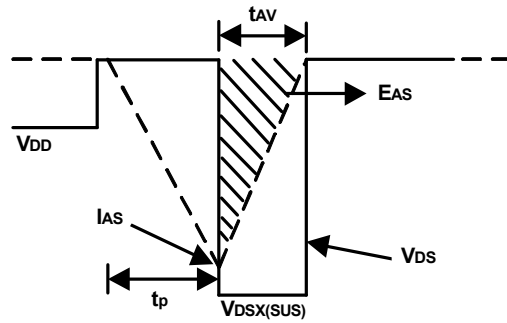
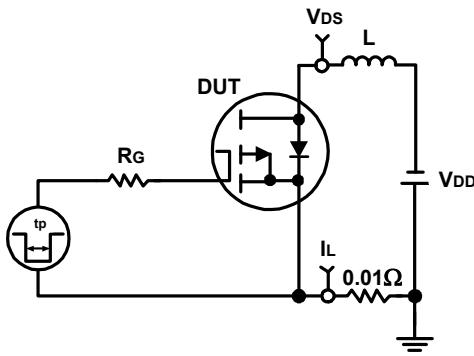

### Switching Time Test Circuit and Waveforms

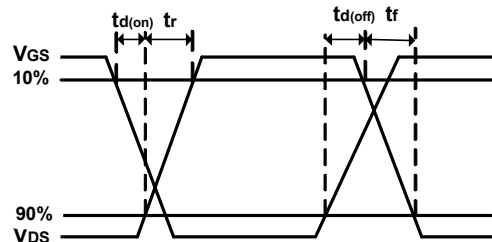
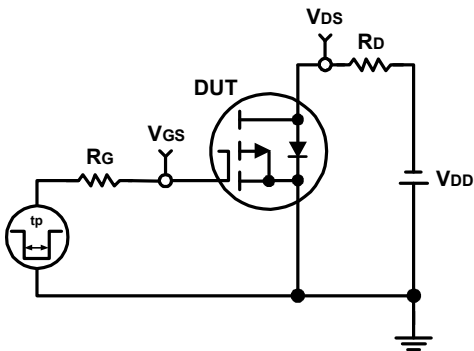

## Package Mechanical Data: TO-252-3L

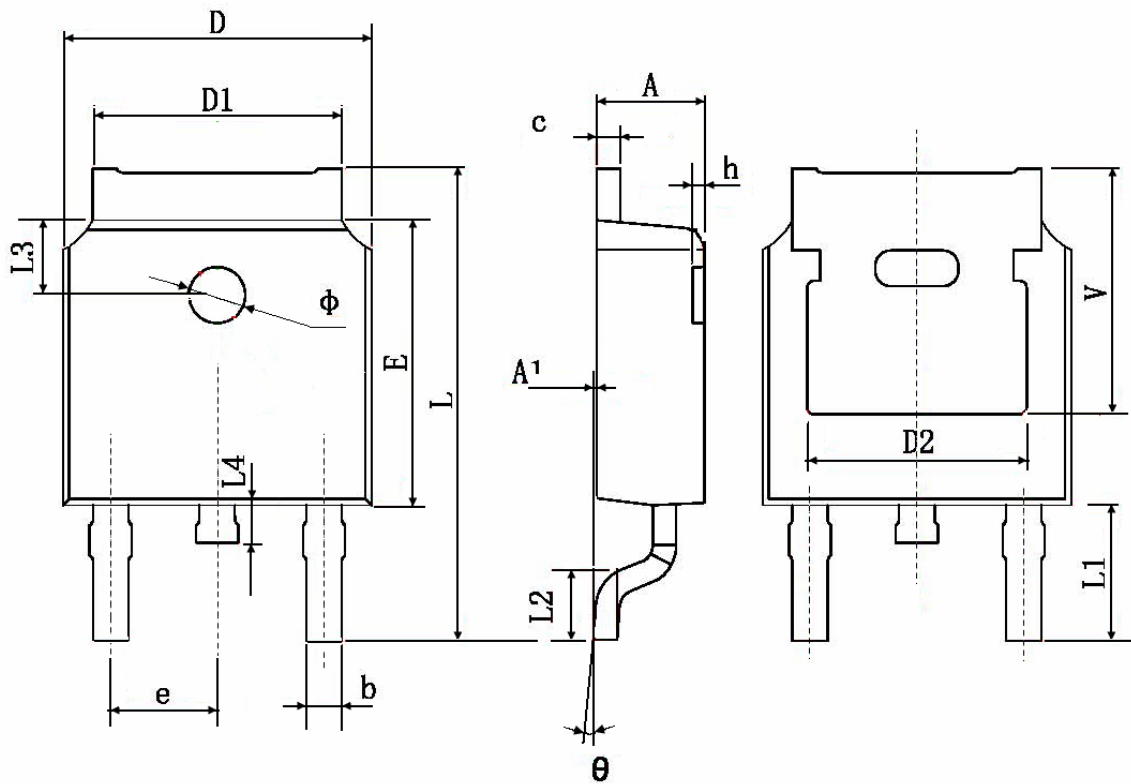

Symbol	Dimensions In Millimeters		Dimensions In Inches	
	Min.	Max.	Min.	Max.
A	2.200	2.400	0.087	0.094
A1	0.000	0.127	0.000	0.005
b	0.660	0.860	0.026	0.034
c	0.460	0.580	0.018	0.023
D	6.500	6.700	0.256	0.264
D1	5.100	5.460	0.201	0.215
D2	4.830 TYP.		0.190 TYP.	
E	6.000	6.200	0.236	0.244
e	2.186	2.386	0.086	0.094
L	9.800	10.400	0.386	0.409
L1	2.900 TYP.		0.114 TYP.	
L2	1.400	1.700	0.055	0.067
L3	1.600 TYP.		0.063 TYP.	
L4	0.600	1.000	0.024	0.039
φ	1.100	1.300	0.043	0.051
θ	0°	8°	0°	8°
h	0.000	0.300	0.000	0.012
V	5.350 TYP.		0.211 TYP.	



## X-ON Electronics

Largest Supplier of Electrical and Electronic Components

*Click to view similar products for [MOSFET](#) category:*

*Click to view products by [Tritech-MOS](#) manufacturer:*

Other Similar products are found below :

[IRFD120](#) [JANTX2N5237](#) [BUK455-60A/B](#) [MIC4420CM-TR](#) [VN1206L](#) [NDP4060](#) [SI4482DY](#) [IPS70R2K0CEAKMA1](#) [SQD23N06-31L-GE3](#)  
[TK16J60W,S1VQ\(O](#) [2SK2614\(TE16L1,Q\)](#) [DMN1017UCP3-7](#) [DMN1053UCP4-7](#) [SQJ469EP-T1-GE3](#) [NTE2384](#) [DMC2700UDMQ-7](#)  
[DMN2080UCB4-7](#) [DMN61D9UWQ-13](#) [US6M2GTR](#) [DMN31D5UDJ-7](#) [DMP22D4UFO-7B](#) [DMN1006UCA6-7](#) [DMN16M9UCA6-7](#)  
[STF5N65M6](#) [IRF40H233XTMA1](#) [STU5N65M6](#) [DMN6022SSD-13](#) [DMN13M9UCA6-7](#) [DMTH10H4M6SPS-13](#) [DMN2990UFB-7B](#)  
[IPB80P04P405ATMA2](#) [2N7002W-G](#) [MCAC30N06Y-TP](#) [MCQ7328-TP](#) [NTMC083NP10M5L](#) [BXP7N65D](#) [BXP4N65F](#) [AOL1454G](#)  
[WMJ80N60C4](#) [BXP2N20L](#) [BXP2N65D](#) [BXT1150N10J](#) [BXT1700P06M](#) [TSM60NB380CP](#) [ROG](#) [RQ7L055BGTGR](#) [DMNH15H110SK3-13](#)  
[SLF10N65ABV2](#) [BSO203SP](#) [BSO211P](#) [IPA60R230P6](#)