

TMV3009S

P+P-Channel Enhancement Mode Mosfet

<p>General Description</p> <ul style="list-style-type: none"> • Low $R_{DS(ON)}$ • RoHS and Halogen-Free Compliant <p>Applications</p> <ul style="list-style-type: none"> • Load switch • PWM 	<p>Product Summary</p> <p>$V_{DS} = -30V$ $I_D = -9.0A$ $R_{DS(ON)} = 18m\Omega (typ.) @ V_{GS} = -10V$</p> <p>100% UIS Tested 100% R_g Tested</p> 
--	---

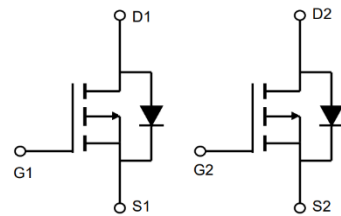
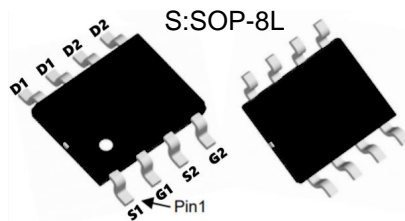
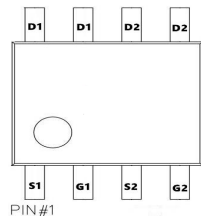

Marking: 9V03 OR 4805

Absolute Maximum Ratings (TC=25°C unless otherwise noted)

Symbol	Parameter	Max.	Units	
V_{DSS}	Drain- Source Voltage	-30	V	
V_{GSS}	Gate- Source Voltage	± 20	V	
I_D	Continuous Drain Current	$T_A = 25^\circ C$	-9.0	A
		$T_A = 100^\circ C$	-5.9	A
I_{DM}	Pulsed Drain Current ^{note1}	-36	A	
E_{AS}	Single Pulsed Avalanche Energy ^{note2}	25	mJ	
P_D	Power Dissipation	$T_A = 25^\circ C$	3.3	W
$R_{\theta JA}$	Thermal Resistance, Junction to Ambient	38	$^\circ C/W$	
T_J, T_{STG}	Operating and Storage Temperature Range	-55 to + 150	$^\circ C$	

Electrical Characteristics ($T_J=25^\circ\text{C}$ unless otherwise specified)

Symbol	Parameter	Conditions	Min.	Typ.	Max.	Unit
BV_{DSS}	Drain- Source Breakdown Voltage	$V_{GS}=0V, I_D=-250\mu A$	-30	---	---	V
$\Delta BV_{DSS}/\Delta T_J$	BV_{DSS} Temperature Coefficient	Reference to 25°C , $I_D=-1\text{mA}$	---	-0.022	---	V/ $^\circ\text{C}$
$R_{DS(ON)}$	Static Drain- Source On-Resistance ²	$V_{GS}=-10V, I_D=-6A$	---	18	25	$\text{m}\Omega$
		$V_{GS}=-4.5V, I_D=-4A$	---	25	42	
$V_{GS(th)}$	Gate Threshold Voltage	$V_{GS}=V_{DS}, I_D=-250\mu A$	-1.0	---	-2.5	V
$\Delta V_{GS(th)}$	$V_{GS(th)}$ Temperature Coefficient		---	4.6	---	$\text{mV}/^\circ\text{C}$
I_{DSS}	Drain- Source Leakage Current	$V_{DS}=-24V, V_{GS}=0V, T_J=25^\circ\text{C}$	---	---	-1	μA
		$V_{DS}=-24V, V_{GS}=0V, T_J=55^\circ\text{C}$	---	---	-5	
I_{GSS}	Gate- Source Leakage Current	$V_{GS}=\pm 20V, V_{DS}=0V$	---	---	± 100	nA
g_{fs}	Forward Transconductance	$V_{DS}=-5V, I_D=-6A$	---	17	---	S
R_g	Gate Resistance	$V_{DS}=0V, V_{GS}=0V, f=1\text{MHz}$	---	13	---	Ω
Q_g	Total Gate Charge (-4.5V)	$V_{DS}=-15V, V_{GS}=-4.5V, I_D=-6A$	---	12.6	---	nC
Q_{gs}	Gate- Source Charge		---	4.8	---	
Q_{gd}	Gate- Drain Charge		---	4.8	---	
$T_{d(on)}$	Turn-On Delay Time	$V_{DD}=-15V, V_{GS}=-10V, R_G=3.3\Omega, I_D=-6A$	---	4.6	---	ns
T_r	Rise Time		---	14.8	---	
$T_{d(off)}$	Turn-Off Delay Time		---	41	---	
T_f	Fall Time		---	19.6	---	
C_{iss}	Input Capacitance	$V_{DS}=-15V, V_{GS}=0V, f=1\text{MHz}$	---	1345	---	PF
C_{oss}	Output Capacitance		---	194	---	
C_{rss}	Reverse Transfer Capacitance		---	158	---	

Diode Characteristics

Symbol	Parameter	Conditions	Min.	Typ.	Max.	Unit
I_S	Continuous Source Current ^{1,5}	$V_G=V_D=0V$, Force Current	---	---	-9.0	A
I_{SM}	Pulsed Source Current ^{2,5}		---	---	-26	A
V_{SD}	Diode Forward Voltage ²	$V_{GS}=0V, I_S=-1A, T_J=25^\circ\text{C}$	---	---	-1.2	V
t_{rr}	Reverse Recovery Time	$I_F=-6A, di/dt=100\text{A}/\mu\text{s}, T_J=25^\circ\text{C}$	---	16.3	---	nS
Q_{rr}	Reverse Recovery Charge		---	5.9	---	nC

Note :

1. The data tested by surface mounted on a 1 inch² FR-4 board with 2OZ copper.
2. The data tested by pulsed, pulse width $\leq 300\mu\text{s}$, duty cycle $\leq 2\%$
3. The EAS data shows Max. rating. The test condition is $V_{DD}=-25V, V_{GS}=-10V, L=0.1\text{mH}, I_{AS}=-38A$
4. The power dissipation is limited by 150°C junction temperature
5. The data is theoretically the same as I_D and I_{DM} , in real applications, should be limited by total power dissipation.

Typical Performance Characteristics

Figure 1 : Output Characteristics

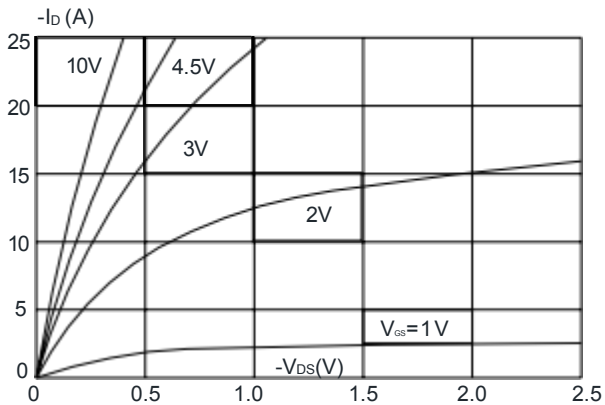

Figure 2 : Typical Transfer Characteristics

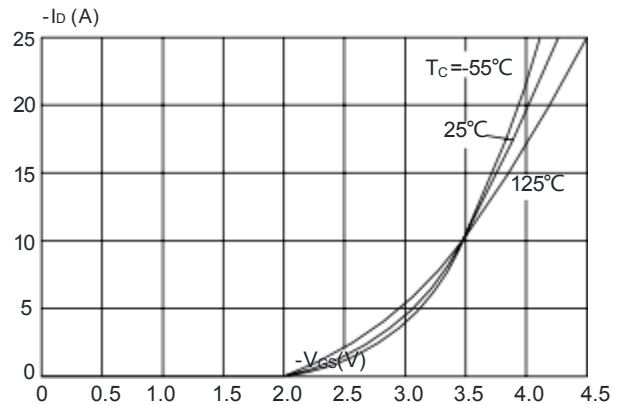

Figure 3 : On-resistance vs. Drain Current

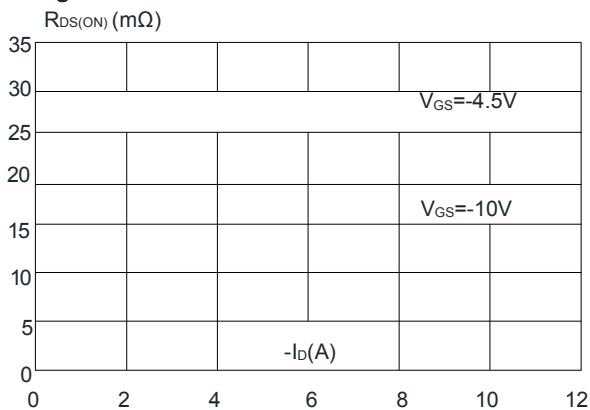

Figure 4 : Body Diode Characteristics

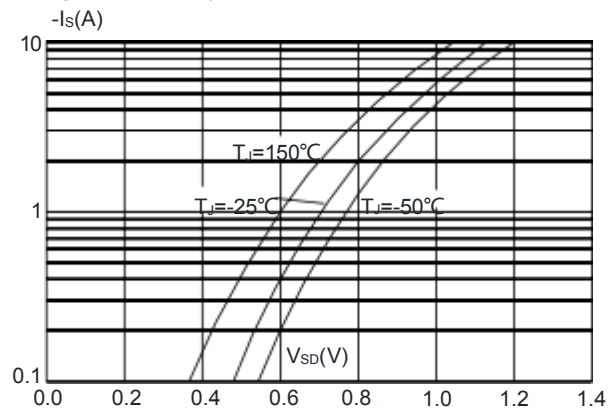

Figure 5 : Gate Charge Characteristics

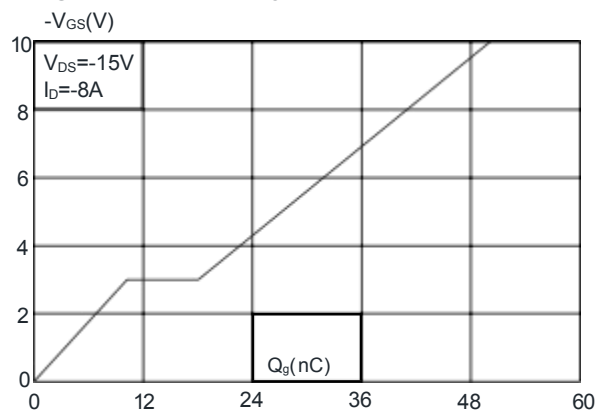
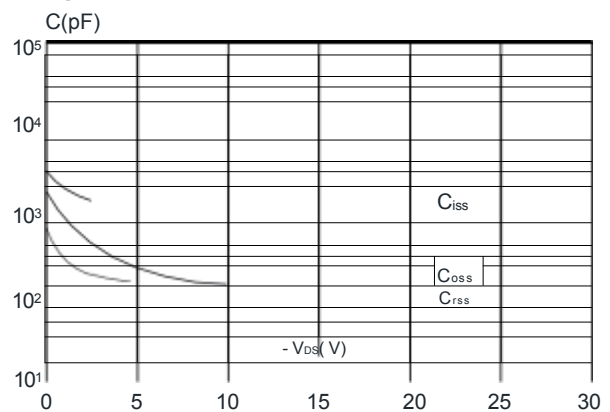

Figure 6 : Capacitance Characteristics



TMV3009S

P+P-Channel Enhancement Mode Mosfet

Figure 7: Normalized Breakdown Voltage vs. Junction Temperature

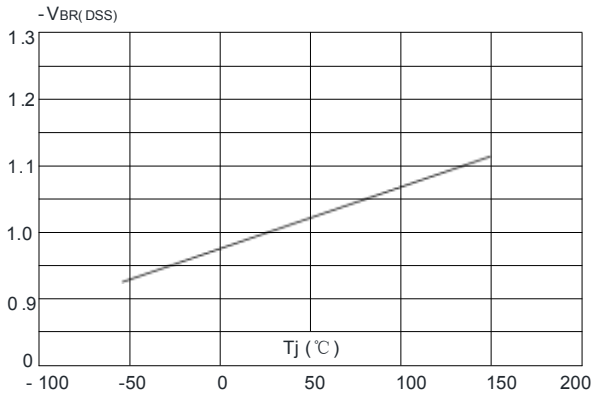

Figure 8: Normalized on Resistance vs. Junction Temperature

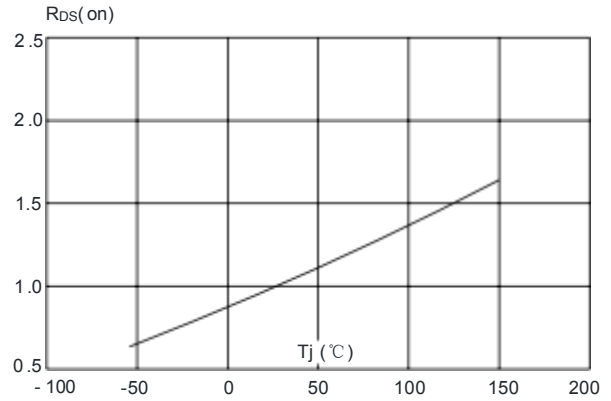

Figure 9: Maximum Safe Operating Area

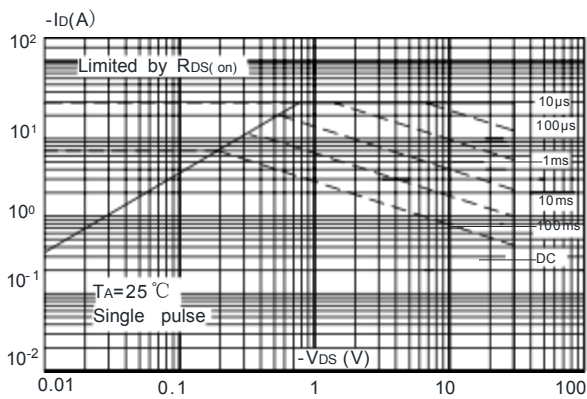
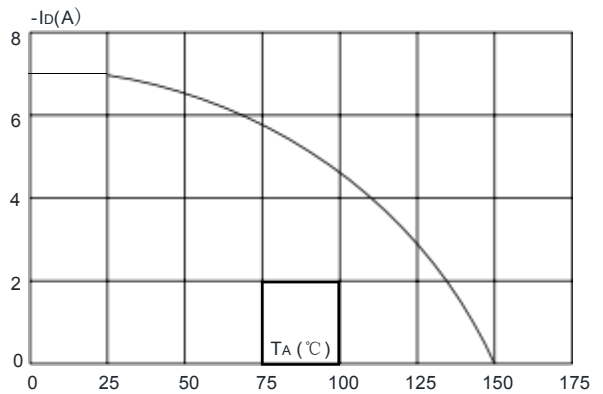
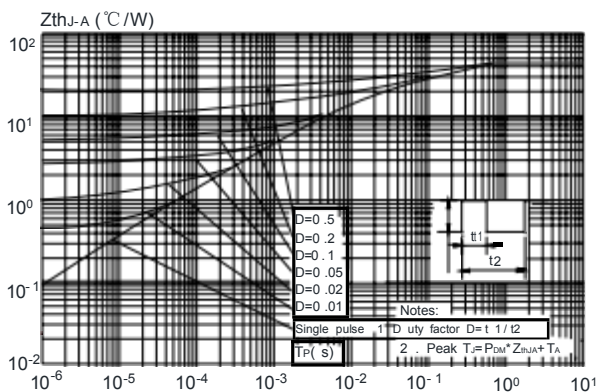

Figure 10: Maximum Continuous Drain Current vs. Ambient Temperature



Maximum Effective Transient Thermal Impedance, Junction-to-Ambient



Package Mechanical Data:SOP-8L

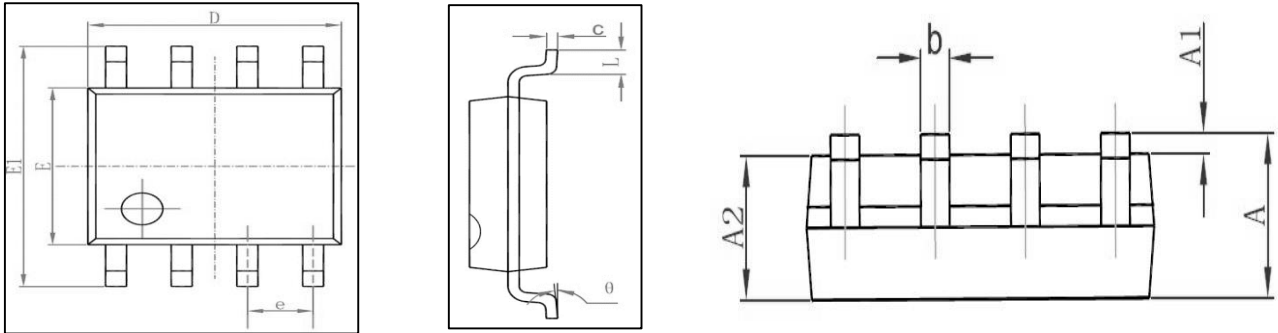

Symbol	Dimensions In Millimeters		Dimensions In Inches	
	Min	Max	Min	Max
A	1.350	1.750	0.053	0.069
A1	0.100	0.250	0.004	0.010
A2	1.350	1.550	0.053	0.061
b	0.330	0.510	0.013	0.020
c	0.170	0.250	0.006	0.010
D	4.700	5.100	0.185	0.200
E	3.800	4.000	0.150	0.157
E1	5.800	6.200	0.228	0.244
e	1.270 (BSC)		0.050 (BSC)	
L	0.400	1.270	0.016	0.050
θ	0°	8°	0°	8°

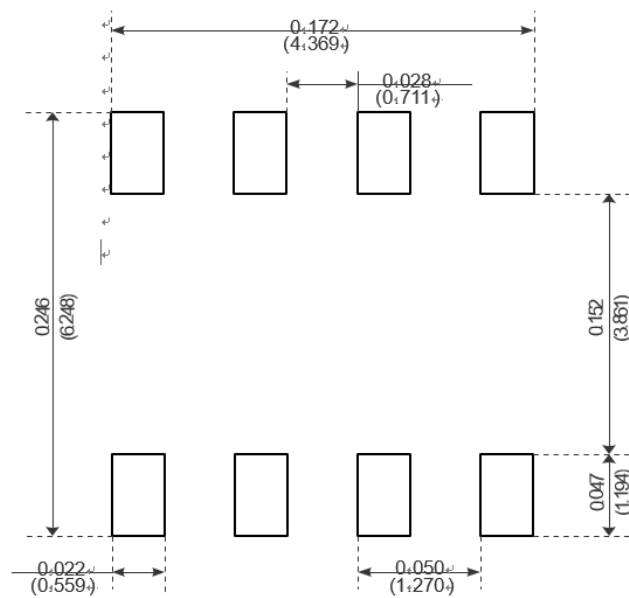

Recommended Minimum Pads

X-ON Electronics

Largest Supplier of Electrical and Electronic Components

Click to view similar products for [MOSFET](#) category:

Click to view products by [Tritech-MOS](#) manufacturer:

Other Similar products are found below :

[IRFD120](#) [JANTX2N5237](#) [BUK455-60A/B](#) [MIC4420CM-TR](#) [VN1206L](#) [NDP4060](#) [SI4482DY](#) [IPS70R2K0CEAKMA1](#) [SQD23N06-31L-GE3](#)
[TK16J60W,S1VQ\(O](#) [2SK2614\(TE16L1,Q\)](#) [DMN1017UCP3-7](#) [DMN1053UCP4-7](#) [SQJ469EP-T1-GE3](#) [NTE2384](#) [DMC2700UDMQ-7](#)
[DMN2080UCB4-7](#) [DMN61D9UWQ-13](#) [US6M2GTR](#) [DMN31D5UDJ-7](#) [DMP22D4UFO-7B](#) [DMN1006UCA6-7](#) [DMN16M9UCA6-7](#)
[STF5N65M6](#) [IRF40H233XTMA1](#) [STU5N65M6](#) [DMN6022SSD-13](#) [DMN13M9UCA6-7](#) [DMTH10H4M6SPS-13](#) [DMN2990UFB-7B](#)
[IPB80P04P405ATMA2](#) [2N7002W-G](#) [MCAC30N06Y-TP](#) [MCQ7328-TP](#) [BXP7N65D](#) [BXP4N65F](#) [AOL1454G](#) [WMJ80N60C4](#) [BXP2N20L](#)
[BXP2N65D](#) [BXT1150N10J](#) [BXT1700P06M](#) [TSM60NB380CP](#) [ROG](#) [RQ7L055BGTCR](#) [DMNH15H110SK3-13](#) [SLF10N65ABV2](#)
[BSO203SP](#) [BSO211P](#) [IPA60R230P6](#) [IPA60R460CE](#)