

Customer	
Production Name	SMD CRYSTAL SEAM 2.0*1.6
Customer P/N	N/A
TROQ P/N	R925000071
Revision	A
Print Date	2023/5/11

Drawn	Checked	Approved
		

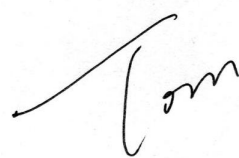
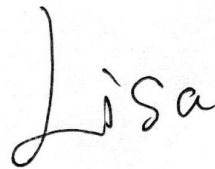

RoHS Compliant

Pb used in sealing glass material is exempt from EU directive

● ELECTRICAL PARAMETERS

谐振器产品技术指标	Min	Max	Units
1.Holder Type(型号规格)	SEAM 2.0*1.6		
2.Mode of Oscillation (振动模式)	Fundamental		
3.Frequency (标称频率)	25.000000		MHz
4.Load Capacitance (CL) (负载电容)	12		pF
5.Shunt Capacitance (Co) (静态电容)	0	5	pF
6.Equivalent Resistance (谐振电阻)		80	Ω
7.Frequency Tolerance at 25℃ (调整频差)	-30	30	ppm
8.Stability over operation temperance (温度频差)	± 25		ppm
9.Insulation Resistance (at D.C. 100V) (绝缘电阻)	500		MΩ
10.Drive Level (激励功率)	100		uw
11.Operating Temperature Range (工作温度范围)	-40	85	℃
12.Storage Temperature Range (储存温度范围)	-40	85	℃
13.Aging (老化率)	± 3		ppm
14.Other(其他)	0		

OUTLINE DIMENSIONS(UNIT:mm) 外形尺寸 (单位: mm)

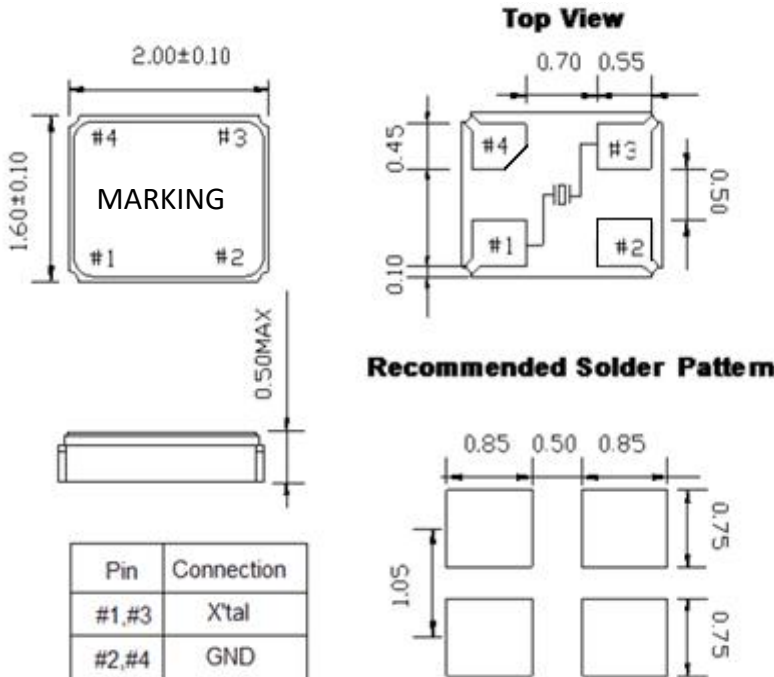

● Marking (标记)

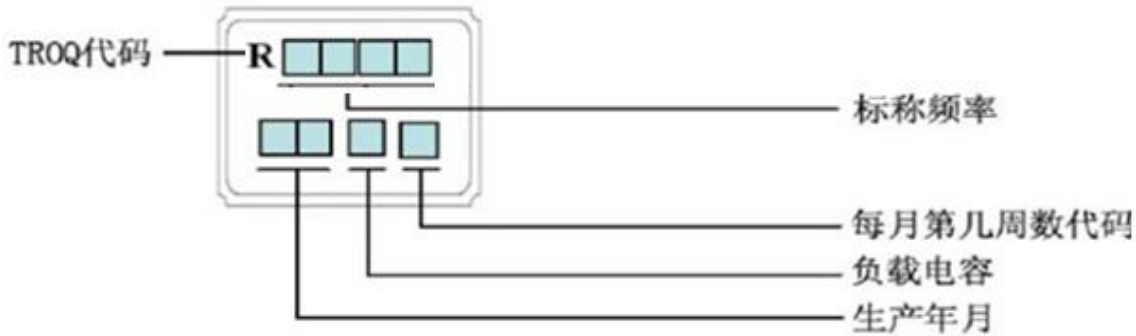

● 负载电容

负载电容 (CL)	5.7	10	12	12.5	15	16	18
代码	A	B	C	D	E	F	G
负载电容 (CL)	20	22	27	30	32	∞	8
代码	H	J	K	M	N	S	R
负载电容 (CL)	7	9	13	7.5			其他
代码	T	V	W	X	Y	Z	P

● 生产年月 (年份为12年一循环)

月份	1	2	3	4	5	6	7	8	9	10	11	12
代码	A	B	C	D	E	F	G	H	K	M	N	P
年份	2020	2021	2022	2023	2024	2025	2026	2027	2028	2029	2030	2031
代码	a	b	c	d	e	f	g	h	k	m	n	p

	周数	第一周	第二周	第三周	第四周	第五周
同订单 不同批 次代码	第一批	1	2	3	4	5
	第二批	A	B	C	D	E
	第三批	F	G	H	J	K
	第四批	L	M	N	P	Q
	第五批	R	S	W	X	Y



说明: 标称频率 25.000MHZ
负载电容20PF
2020年1月份第一周 TROQ制造



TROQ P/N: R925000071 REV: A

● **SUGGESTED REFLOW PROFILE** (回流焊曲线图)

Total time:200sec.Max. (总时间: 200秒 最大)

Solder melting point:220℃ (熔点220℃)

Profiles Feature (特性)		Pb-Free Assembly
Average Ramp-up Rate(Ts max to Tp)	平均升温速度	3℃/second Max
Preheat	预热	
■ Temperature Min (Ts min)	最低温度	125℃
■ Temperature Max (Ts max)	最高温度	200℃
■ Time (ts min to ts max)	从最低到最高时间	(60~180) seconds
Time maintained above	维持上述时间	
■ Temperature(T1)	温度	217℃
■ Time(tp)	时间	(60~150) seconds
Peak/Classification Temperature(Tp)	最高点温度	260℃
Time within 5℃ of actual Peak Temperature(tp)	高温维持时间	(20~40) seconds
Ramp-down rate	降温速度	6℃/second max
Time 25℃ to Peak Temperature	从25℃到最高温度的时间	8 minutes max
Suggest reflow times	建议 reflow次数	3 Times max

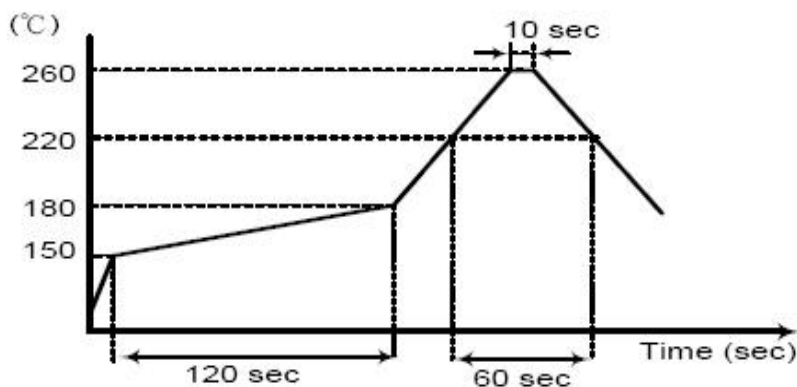

- PACKING (包装) 3Kpcs/REEL

編帶尺寸圖
Taping Dimensions

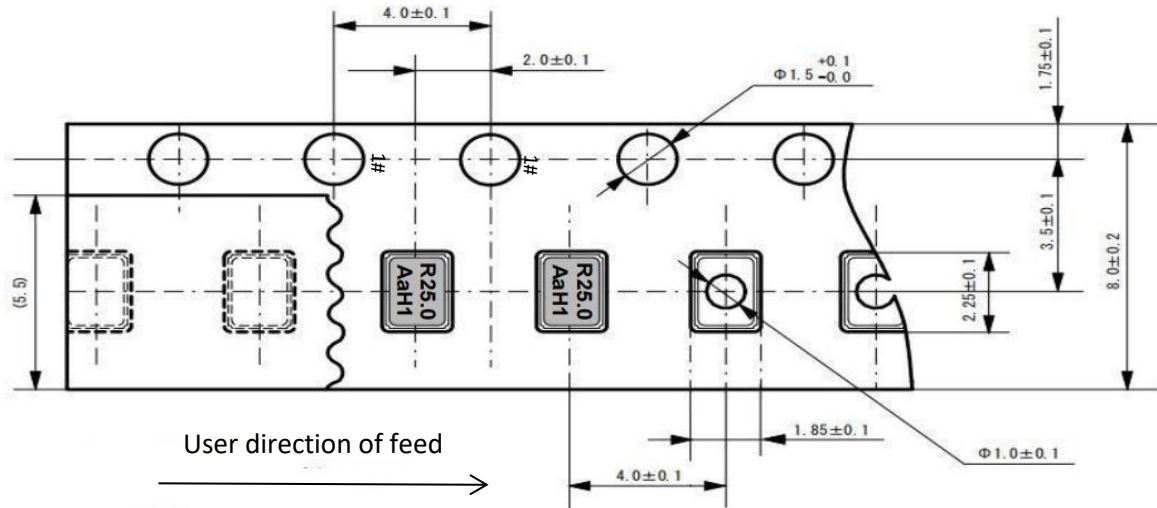

8.3. Reel dimension & Outline drawing

Material of the Reel : PS

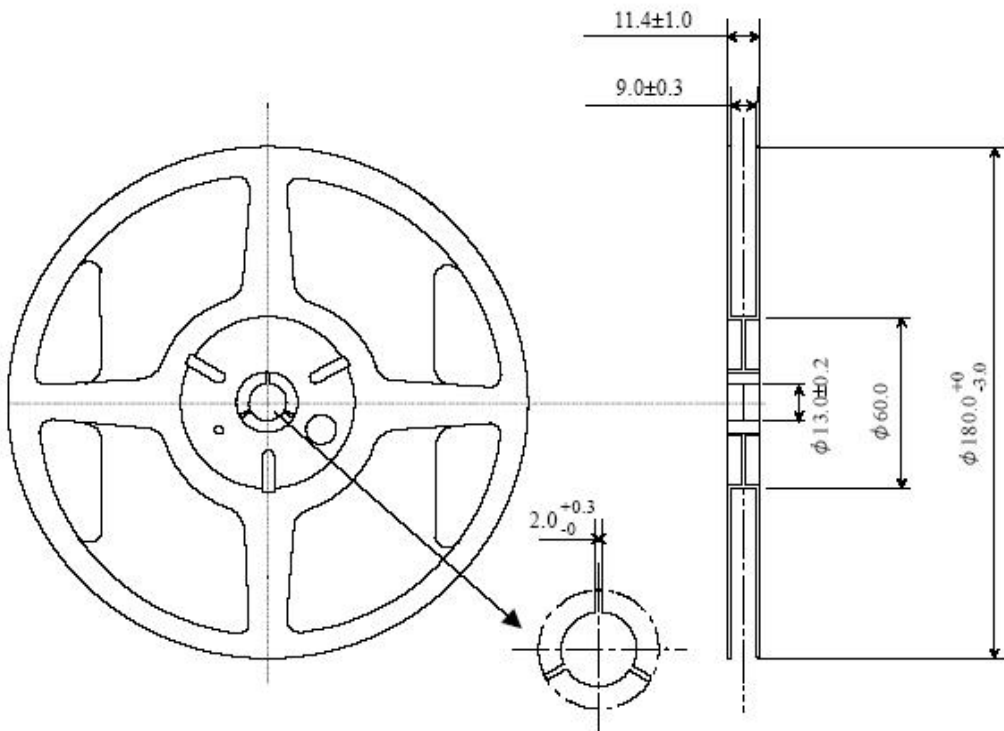

● RELIABILITY SPECIFICATIONS (信赖度试验)

No	Test Item (测试项目)	Test Conditions (测试条件)	Reference (参考)
1	High Temperature High Humidity Storage (高温、高湿、储存)	Temperature: 85°C±3°C 温度: 85°C±3°C Relative Humidity:85%RH 相对湿度: 85%RH Time: 96 Hours 时间: 96小时	JIS C5023
2	High Temperature Storage (高温储存)	Temperature: 125°C±3°C 温度:125°C±3°C Time: 96 Hours 时间:96 小时	MIL-STD-883E Method 1005.8
3	Low Temperature Storage (低温储存)	Temperature: -40°C±3°C 温度: -40°C±3°C Time: 96Hours 时间: 96小时	MIL-STD-883E Method 1013
4	Thermal Shock (温度冲击)	Temperature1:-55°C±5°C 温度1:-55°C±5°C Temperature2:85°C±5°C 温度2: 85°C±5°C Temperature change between T1 and T2 5 min T1和T2温度在5分钟内改变 10cycles maintain T1 and T2 for 30 minutes each mone cycle 每次循环30分钟共10次	MIL-STD-202F Method 107 Condition A
5	RESISTANCE TO SOLDER HEAT (耐焊接热)	Solder Temperature: 260°C±5°C 焊槽温度:260°C±5°C Time: 10±1 Seconds 时间: 10±1秒	MIL-STD-202F Method 210E
6	Solderability(可焊性)	The solder pot temperature is 245±5°C , dwell time 5±0.5 245±5°C焊锡槽浸润5±0.5秒	J-STD-002B
7	Drop Test (落下试验)	3 Times Free Fall from 75cm height table to 3cm thickness hard wood board 从75cm高度3次跌落到3cm厚硬质木板上	JIS C6701
8	MECHANICAL SHOCK (机械冲击)	Half sine wave,1000 G 半正弦波,加速度1000G 3 Times for all 3 directions X、Y、Z 三个相互垂直方向各三次	MIL-STD-202F Method 213B
9	Vibration (机械振动)	Frequency Range: 10Hz~55Hz 频率范围: 10Hz~55Hz Amplitude: 0.75mm 振幅: 0.75mm 2 Hours in each direction, total 6 Hours X、Y、Z 三个相互垂直方向各振动2小时	MIL-STD-883E Method 2007.3
10	Leakage Test (气密性)	Take measurements with a helium Leakage detector 氦质检漏 Leakage Rate≤1×10 ⁻³ Pa cm ³ /s 漏率≤1×10 ⁻³ Pa cm ³ /s	MIL-STD-883E

X-ON Electronics

Largest Supplier of Electrical and Electronic Components

Click to view similar products for [Crystals](#) category:

Click to view products by [TROQ](#) manufacturer:

Other Similar products are found below :

[CX3225GB25000M0PPSZ1](#) [718-13.2-1](#) [7A-40.000MAAE-T](#) [FL2000085](#) [99-BU](#) [9B-15.360MBBK-B](#) [9C-7.680MBBK-T](#) [H10S-12.000-18-EXT-TR](#) [ABC2-6.000MHZ-D4Z-T](#) [ABLS-20.000MHZ-D2-T](#) [ABS071-32.768KHZ-6-T](#) [R38-32.768-12.5-5PPM-NPB](#) [21U15A-21.4MHZ](#) [RTX-781DF1-S-20.950](#) [LFXTAL066198Cutt](#) [9C-14.31818MBBK-T](#) [A-11.000MHZ-27](#) [ABL-27.000MHZ-B4Y-T](#) [ABM11-132-24.000MHZ-T3](#) [ABM3B1-25.000MHZ-D2Y-T](#) [SPT2A-.032768B](#) [SPT2A.032768G](#) [SSPT7F-9PF20-R](#) [LFXTAL065253Cutt](#) [LFXTAL066431Cutt](#) [XT9S20ANA14M7456](#) [XT9SNLANA16M](#) [7A-24.576MBBK-T](#) [7B-30.000MBBK-T](#) [CX2520DB16000H0HPQCC](#) [MMCC2R32.7680KHZ](#) [6504-202-1501](#) [6526-202-1501](#) [ABLS-12.000MHZ-B2Y-T](#) [7A-10.000MBBK-T](#) [SG636PCE-20.000MC](#) [3404](#) [CM315D32768EZFT](#) [C1E-24.000-7-2020-R](#) [C1E-19.200-12-1530-X-R](#) [C1E-16.000-12-1530-X-R](#) [ABM11-16.000MHZ-9-B1U-T](#) [FL5000014](#) [EUCA18-3.1872M](#) [FX0800015](#) [425F35E027M0000](#) [FP0800018](#) [MS3V-T1R-32.768kHz-7pF-20PPM-TA-QC-Au](#) [VXM7-1C1-16M000](#) [MS3V-T1R-32.768kHz-9pF-20PPM-TA-QC-Au](#)