





TROQ Electronic Co.,Ltd.
CRYSTAL UNIT SPECIFICATIONS

Customer	
Production Name	DIP CRYSTAL HC-49S
Customer P/N	N/A
TROQ P/N	RB073721244
Revision	A
Print Date	2023/5/11

Drawn	Checked	Approved
		

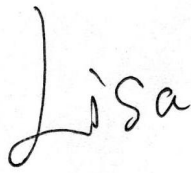

● ELECTRICAL PARAMETERS

谐振器产品技术指标	Min	Max	Units
1.Holder Type(型号规格)	HC-49S		
2.Mode of Oscillation (振动模式)	Fundamental		
3.Frequency (标称频率)	7.372800		MHz
4.Load Capacitance (CL) (负载电容)	20		pF
5.Shunt Capacitance (Co) (静态电容)	0	5	pF
6.Equivalent Resistance (谐振电阻)		80	Ω
7.Frequency Tolerance at 25°C (调整频差)	-20	20	ppm
8.Stability over operation temperance (温度频差)	± 20		ppm
9.Insulation Resistance (at DC 100V) (绝缘电阻)	500		M Ω
10.Drive Level (激励功率)	100		uw
11.Operating Temperature Range (工作温度范围)	-40	85	$^{\circ}\text{C}$
12.Storage Temperature Range (储存温度范围)	-40	85	$^{\circ}\text{C}$
13. Aging (老化率)	± 5		ppm/year
14.Other(其它):	0		

OUTLINE DIMENSIONS(UNIT:mm) 外形尺寸 (单位: mm)

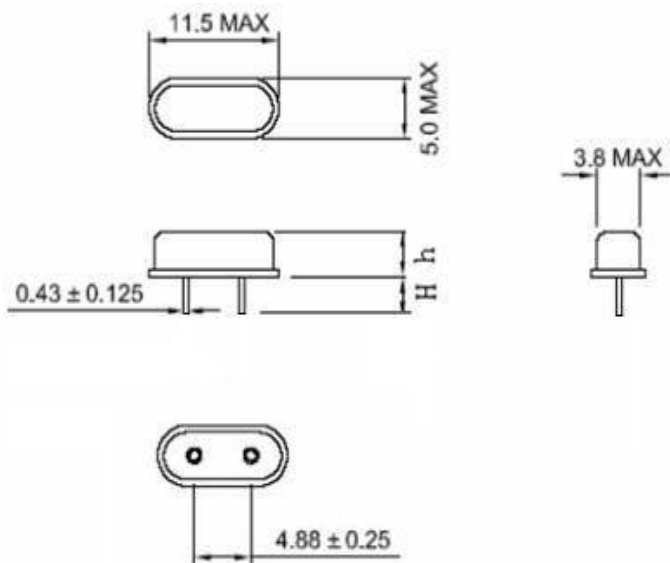

h:	3.3 ± 0.30
H:	13.2 ± 0.5

● Marking (标记)

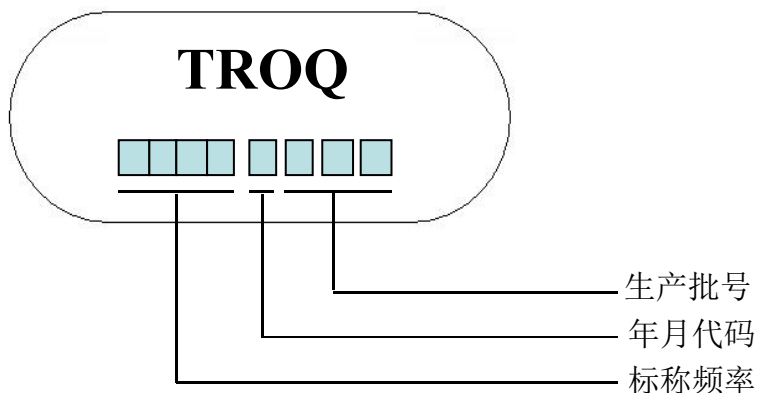

● 年月代码

2020月份	1	2	3	4	5	6	7	8	9	10	11	12
2020年月码	A	B	C	D	E	F	G	H	J	K	L	M
2021月份	1	2	3	4	5	6	7	8	9	10	11	12
2021年月码	N	P	Q	R	S	T	U	V	W	X	Y	Z
2022月份	1	2	3	4	5	6	7	8	9	10	11	12
2022年月码	a	b	c	d	e	f	g	h	j	k	l	m
2023月份	1	2	3	4	5	6	7	8	9	10	11	12
2023年月码	n	p	q	r	s	t	u	v	w	x	y	z

注: 以上年月代码每四年一个循环。

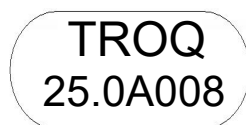

→ 说明: 标称频率 25.000MHZ
2020年1月份制造, 生产批号为008
上述产品标志从2012年1月1日正式执



TROQ P/N: RB073721244 REV: A

● **SUGGESTED REFLOW PROFILE** (回流焊曲线图)

Total time:200sec.Max. (总时间: 200秒 最大)

Solder melting point:220°C (熔点220 °C)

Profiles Feature (特性)		Pb-Free Assembly
Average Ramp-up Rate(Ts max to Tp)平均升温速度		3°C/second Max
Preheat	预热	
■ Temperature Min (Ts min)	最低温度	125°C
■ Temperature Max (Ts max)	最高温度	200°C
■ Time (ts min to ts max)	从最低到最高时间	(60~180) seconds
Time maintained above	维持上述时间	
■ Temperature(T1)	温度	217°C
■ Time(tp)	时间	(60~150) seconds
Peak/Classification Temperature(Tp) 最高点温度		260 °C
Time within 5°C of actual Peak Temperature(tp)	高温维持时间	(20~40) seconds
Ramp-down rate	降温速度	6°C/second max
Time 25°C to Peak Temperature	从25°C到最高温度的时间	8 minutes max
Suggest reflow times	建议 reflow次数	3 Times max

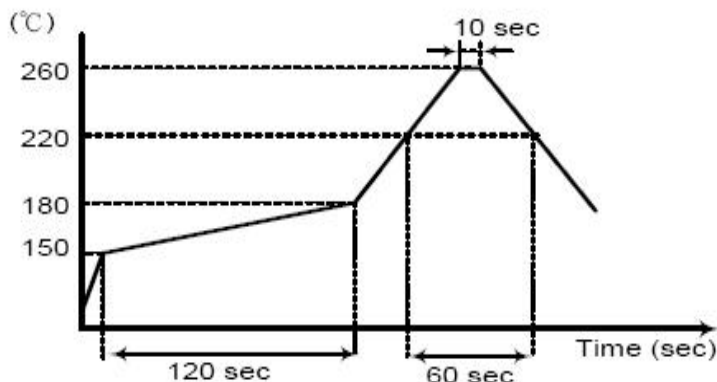

● PACKING (包装)

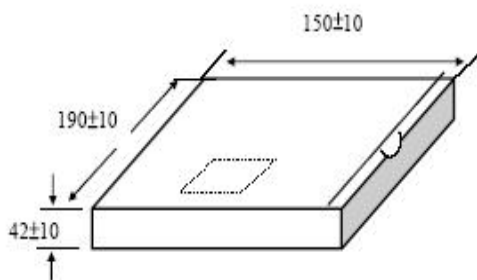
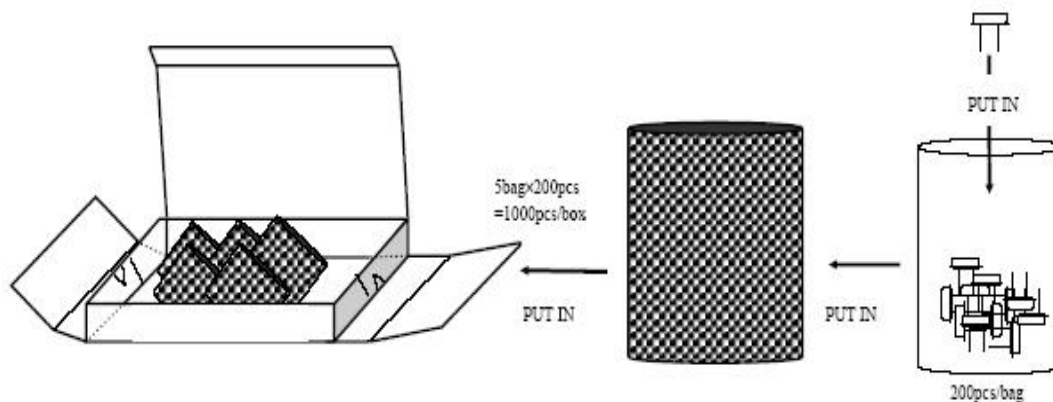



TROQ P/N: RB073721244 REV: A

● RELIABILITY SPECIFICATIONS (信赖度试验)

No	Test Item (测试项目)	Test Conditions (测试条件)	Reference (参考)
1	High Temperature High Humidity Storage (高温、高湿、储存)	Temperature: 85°C±3°C 温度: 85°C±3°C Relative Humidity: 85%RH 相对湿度: 85%RH Time: 96 Hours 时间: 96小时	JIS C5023
2	High Temperature Storage (高温储存)	Temperature: 125°C±3°C 温度: 125°C±3°C Time: 96 Hours 时间: 96小时	MIL-STD-883E Method 1005.8
3	Low Temperature Storage (低温储存)	Temperature: -40°C±3°C 温度: -40°C±3°C Time: 96Hours 时间: 96小时	MIL-STD-883E Method 1013
4	Thermal Shock (温度冲击)	Temperature1: -55°C±5°C 温度1: -55°C±5°C Temperature2: 85°C±5°C 温度2: 85°C±5°C Temperature change between T1 and T2 5 min T1和T2温度在5分钟内改变 10cycles maintain T1 and T2 for 30 minutes each mone 每次循环30分钟共10次	MIL-STD-202F Method 107 Condition A
5	RESISTANCE TO SOLDER HEAT (耐焊接热)	Solder Temperature: 265°C±5°C 焊槽温度: 265°C±5°C Time: 10±1 Seconds 时间: 10±1秒	MIL-STD-202F Method 210E
6	Solderability(可焊性)	The solder pot temperature is 245±5°C , dwell time 245±5°C焊锡槽浸润5±0.5秒	J-STD-002B
7	Drop Test (落下试验)	3 Times Free Fall from 50cm height table to 3cm thickness hard wood board 从50cm高度3次跌落到3cm厚硬质木板上	JIS C6701
8	MECHANICAL SHOCK (机械冲击)	Half sine wave, 1000 G 半正弦波, 加速度1000G 3 Times for all 3 directions X、Y、Z 三个相互垂直方向各三次	MIL-STD-202F Method 213B
9	Vibration (机械振动)	Frequency Range: 10Hz~55Hz 频率范围: 10Hz~55Hz Amplitude: 0.75mm 振幅: 0.75mm 2 Hours in each direction, total 6 Hours X、Y、Z 三个相互垂直方向各振动2小时	MIL-STD-883E Method 2007.3
10	Leakage Test (气密性)	Take measurements with a helium Leakage detector 氦质检漏 Leakage Rate ≤ 1×10 ⁻³ Pa cm ³ /s 漏率 ≤ 1×10 ⁻³ Pa cm ³ /s	MIL-STD-883E

X-ON Electronics

Largest Supplier of Electrical and Electronic Components

Click to view similar products for [Crystals](#) category:

Click to view products by [TROQ](#) manufacturer:

Other Similar products are found below :

[CX3225GB25000M0PPSZ1](#) [718-13.2-1](#) [7A-40.000MAAE-T](#) [FL2000085](#) [99-BU](#) [9B-15.360MBBK-B](#) [9C-7.680MBBK-T](#) [H10S-12.000-18-EXT-TR](#) [ABC2-6.000MHZ-D4Z-T](#) [ABLS-20.000MHZ-D2-T](#) [ABS071-32.768KHZ-6-T](#) [R38-32.768-12.5-5PPM-NPB](#) [21U15A-21.4MHZ](#) [RTX-781DF1-S-20.950](#) [LFXTAL066198Cutt](#) [9C-14.31818MBBK-T](#) [A-11.000MHZ-27](#) [ABL-27.000MHZ-B4Y-T](#) [ABM11-132-24.000MHZ-T3](#) [ABM3B1-25.000MHZ-D2Y-T](#) [SPT2A-.032768B](#) [SPT2A.032768G](#) [SSPT7F-9PF20-R](#) [LFXTAL065253Cutt](#) [LFXTAL066431Cutt](#) [XT9S20ANA14M7456](#) [XT9SNLANA16M](#) [7A-24.576MBBK-T](#) [7B-30.000MBBK-T](#) [CX2520DB16000H0HPQCC](#) [MMCC2R32.7680KHZ](#) [6504-202-1501](#) [6526-202-1501](#) [ABLS-12.000MHZ-B2Y-T](#) [7A-10.000MBBK-T](#) [SG636PCE-20.000MC](#) [3404](#) [CM315D32768EZFT](#) [C1E-24.000-7-2020-R](#) [C1E-19.200-12-1530-X-R](#) [C1E-16.000-12-1530-X-R](#) [ABM11-16.000MHZ-9-B1U-T](#) [FL5000014](#) [EUCA18-3.1872M](#) [FX0800015](#) [425F35E027M0000](#) [FP0800018](#) [MS3V-T1R-32.768kHz-7pF-20PPM-TA-QC-Au](#) [VXM7-1C1-16M000](#) [MS3V-T1R-32.768kHz-9pF-20PPM-TA-QC-Au](#)