

# TSA40N25M

## 250V N-Channel MOSFET

### General Description

This Power MOSFET is produced using Truesemi's advanced planar stripe DMOS technology. This advanced technology has been especially tailored to minimize on-state resistance, provide superior switching performance, and withstand high energy pulse in the avalanche and commutation mode. These devices are well suited for high efficiency switched mode power supplies, active power factor correction based on half bridge topology.

### Features

- 40A,250V,Max.RDS(on)=85mΩ @ VGS=10V
- Low gate charge:Qg=62nC (Typ.)
- Low reverse transfer capacitance: Crss=40pF (Typ.)
- Lower EMI noise
- 100% avalanche tested
- RoHS compliant device

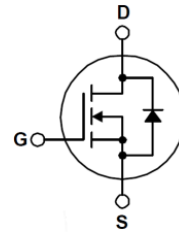
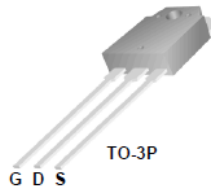

### Absolute Maximum Ratings T<sub>C</sub>=25°C unless otherwise specified

Symbol	Parameter	TSA40N25M	Units
V <sub>DSS</sub>	Drain-Source Voltage	250	V
V <sub>GS</sub>	Gate-Source Voltage	± 30	V
I <sub>D</sub>	Drain Current	T <sub>C</sub> = 25°C	40
		T <sub>C</sub> = 100°C	25.3
I <sub>DM</sub>	Pulsed Drain Current (Note 1)	160	A
E <sub>AS</sub>	Single Pulsed Avalanche Energy (Note 2)	1000	mJ
I <sub>AR</sub>	Repetitive avalanche current (Note 1)	40	A
E <sub>AR</sub>	Repetitive Avalanche Energy (Note 1)	5.8	mJ
P <sub>D</sub>	Power Dissipation	260	W
T <sub>J</sub> , T <sub>STG</sub>	Operating and Storage Temperature Range	-55 to +150	°C

\* Drain current limited by maximum junction temperature.

### Thermal Resistance Characteristics

Symbol	Parameter	Rating	Units
R <sub>θJC</sub>	Thermal Resistance,Junction-to-Case	Max.0.48	°C/W
R <sub>θJA</sub>	Thermal Resistance,Junction-to-Ambient	Max.62.5	°C/W

### Electrical Characteristics $T_C=25^\circ\text{C}$ unless otherwise specified

Symbol	Parameter	Test Conditions	Min	Typ	Max	Units
--------	-----------	-----------------	-----	-----	-----	-------

#### On Characteristics

$V_{GS}$	Gate Threshold Voltage	$V_{DS} = V_{GS}, I_D = 250 \mu\text{A}$	2.0	--	4.0	V
$R_{DS(ON)}$	Static Drain-Source On-Resistance	$V_{GS} = 10 \text{ V}, I_D = 20 \text{ A}$	--	70	85	m $\Omega$

#### Off Characteristics

$BV_{DSS}$	Drain-Source Breakdown Voltage	$V_{GS} = 0 \text{ V}, I_D = 250 \mu\text{A}$	250	--	--	V
$\Delta BV_{DSS} / \Delta T_J$	Breakdown Voltage Temperature Coefficient	$I_D = 250 \mu\text{A}$ , Referenced to $25^\circ\text{C}$	--	1	--	V/ $^\circ\text{C}$
$I_{DSS}$	Zero Gate Voltage Drain Current	$V_{DS} = 250 \text{ V}, V_{GS} = 0 \text{ V}$	--	--	10	$\mu\text{A}$
		$V_{DS} = 250 \text{ V}, T_J = 125^\circ\text{C}$	--	--	100	$\mu\text{A}$
$I_{GSSF}$	Gate-Body Leakage Current, Forward	$V_{GS} = 20 \text{ V}, V_{DS} = 0 \text{ V}$	--	--	100	nA
$I_{GSSR}$	Gate-Body Leakage Current, Reverse	$V_{GS} = -20 \text{ V}, V_{DS} = 0 \text{ V}$	--	--	-100	nA

#### Dynamic Characteristics

$C_{iss}$	Input Capacitance	$V_{DS} = 25 \text{ V}, V_{GS} = 0 \text{ V}, f = 1.0 \text{ MHz}$	--	2704	--	pF
$C_{oss}$	Output Capacitance		--	325	--	pF
$C_{rss}$	Reverse Transfer Capacitance		--	40	--	pF

#### Switching Characteristics

$t_{d(on)}$	Turn-On Time	$V_{DS} = 125 \text{ V}, I_D = 20 \text{ A}, R_G = 25 \Omega$ (Note 3,4)	--	42	--	ns
$t_r$	Turn-On Rise Time		--	26	--	ns
$t_{d(off)}$	Turn-Off Delay Time		--	155	--	ns
$t_f$	Turn-Off Fall Time		--	32	--	ns
$Q_g$	Total Gate Charge	$V_{DS} = 125 \text{ V}, I_D = 20 \text{ A}, V_{GS} = 10 \text{ V}$ (Note 3,4)	--	62	--	nC
$Q_{gs}$	Gate-Source Charge		--	16	--	nC
$Q_{gd}$	Gate-Drain Charge		--	18	--	nC

#### Source-Drain Diode Maximum Ratings and Characteristics

$I_S$	Continuous Source-Drain Diode Forward Current	--	--	40	A	
$I_{SM}$	Pulsed Source-Drain Diode Forward Current	--	--	160		
$V_{SD}$	Source-Drain Diode Forward Voltage	$I_S = 40 \text{ A}, V_{GS} = 0 \text{ V}$	--	--	1.4	V
$t_{rr}$	Reverse Recovery Time	$I_S = 20 \text{ A}, V_{GS} = 0 \text{ V}$	--	167	--	ns
$Q_{rr}$	Reverse Recovery Charge	$di_F/dt = 100 \text{ A}/\mu\text{s}$ (Note 3,4)	--	1.25	--	$\mu\text{C}$

#### NOTES:

1. Repetitive Rating: Pulse width limited by safe operating area
2.  $L=1\text{mH}, I_{AS}=40\text{A}, V_{DD}=50\text{V}, R_G=25 \Omega$ , Starting  $T_J=25^\circ\text{C}$
3. Pulse test: Pulse width  $\leq 300\mu\text{s}$ , Duty cycle  $\leq 2\%$
4. Essentially independent of operating temperature typical characteristics

# Typical Electrical Characteristics Curves

Fig. 1 Typical Output Characteristics

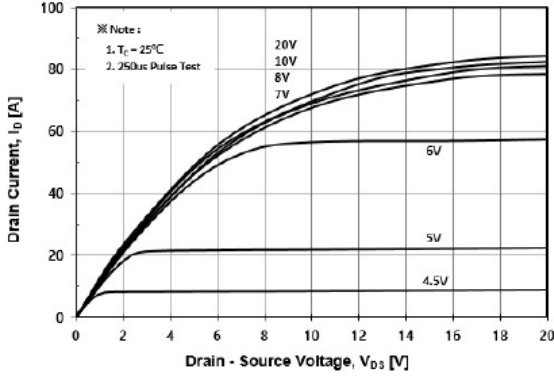

Fig. 2 Typical Transfer Characteristics

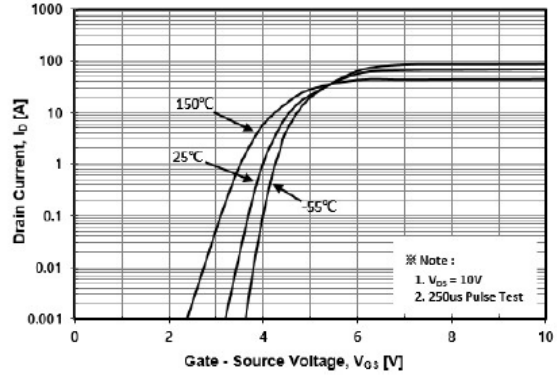

Fig.3 On-Resistance Variation with Drain Current and Gate Voltage

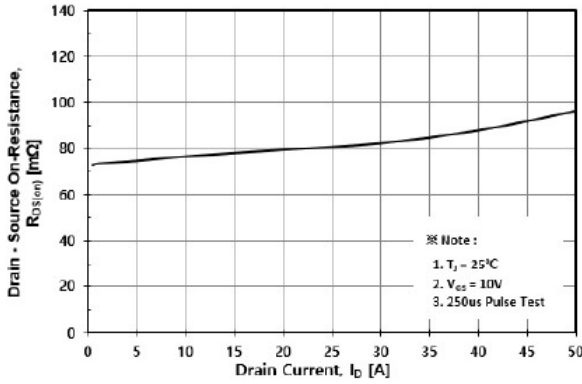

Fig. 4 Body Diode Forward Voltage Variation with Source Current

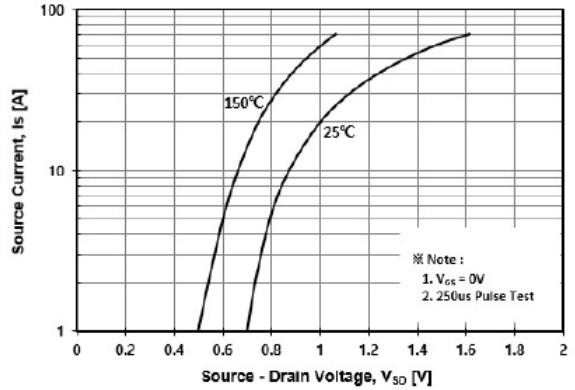

Fig. 5 Typical Capacitance Characteristics

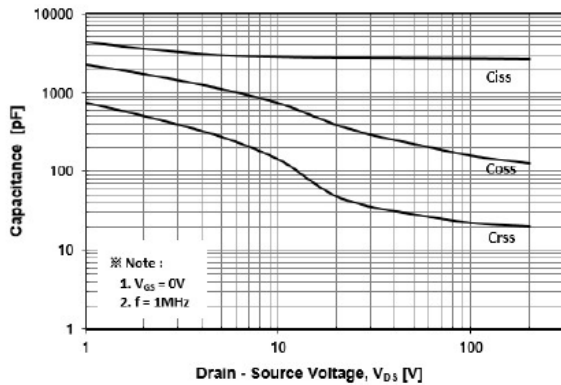
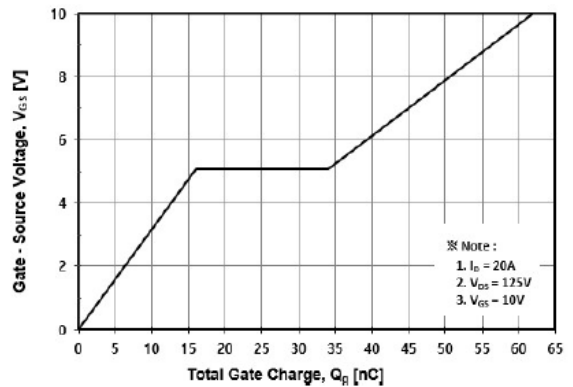

Fig. 6 Typical Total Gate Charge Characteristics



# Typical Electrical Characteristics Curves

Fig. 7 Breakdown Voltage Variation vs. Temperature

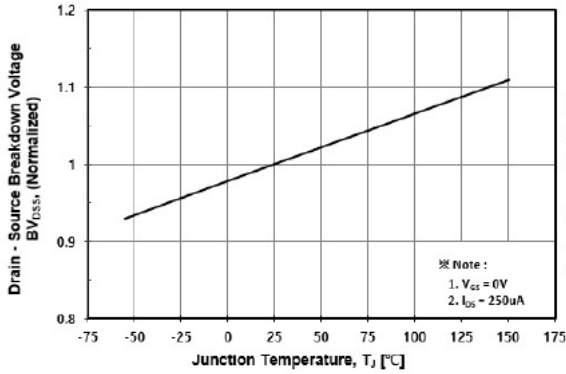

Fig. 8 On-Resistance Variation vs. Temperature

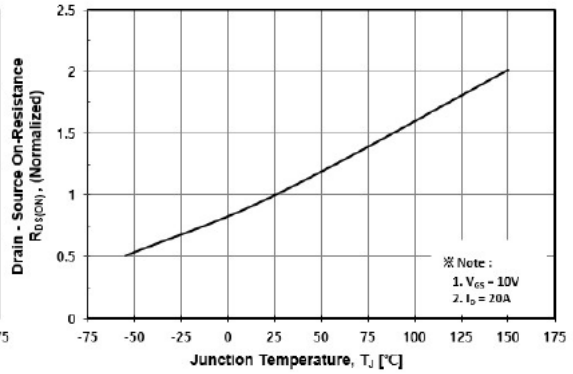

Fig. 9 Maximum Drain Current vs. Case Temperature

Fig. 9 Maximum Drain Current vs. Case Temperature

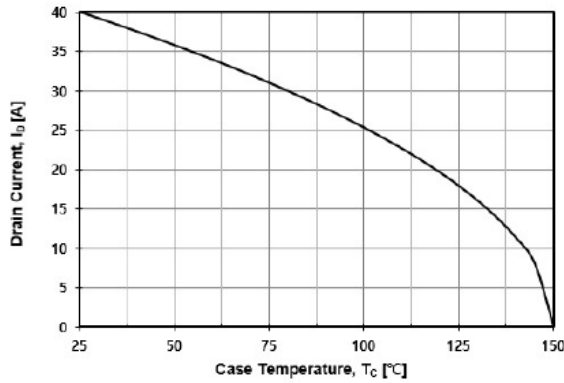

Fig. 10 Maximum Safe Operating Area

Fig. 10 Maximum Safe Operating Area

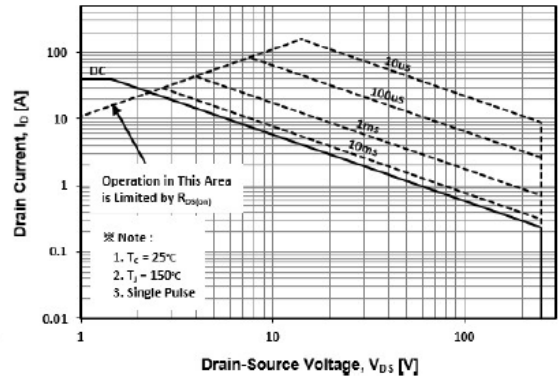
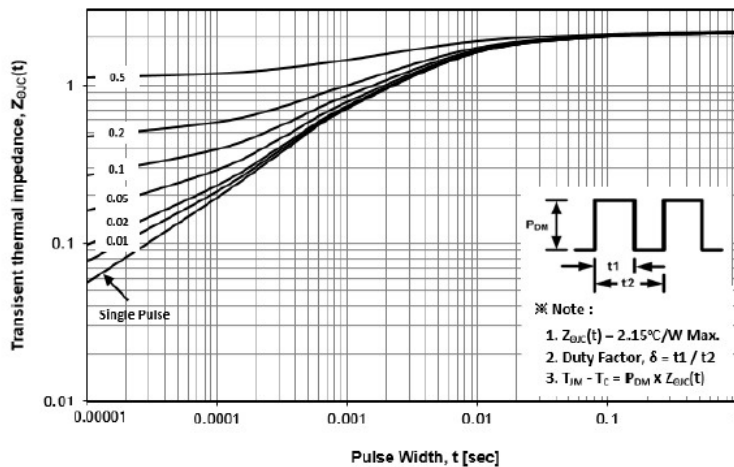
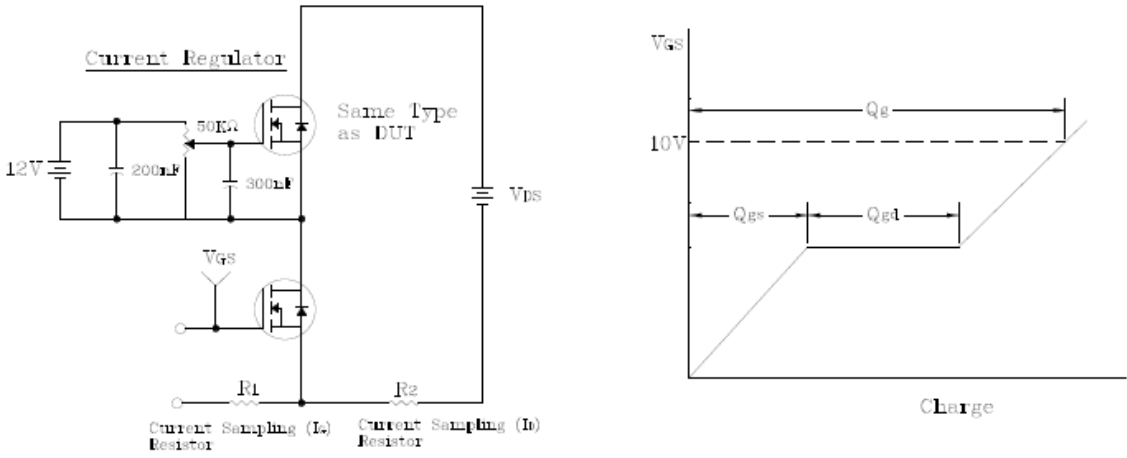

Fig. 11 Transient Thermal Impedance



**Fig. 12 Gate Charge Test Circuit & Waveform**



**Fig. 13 Resistive Switching Test Circuit & Waveform**

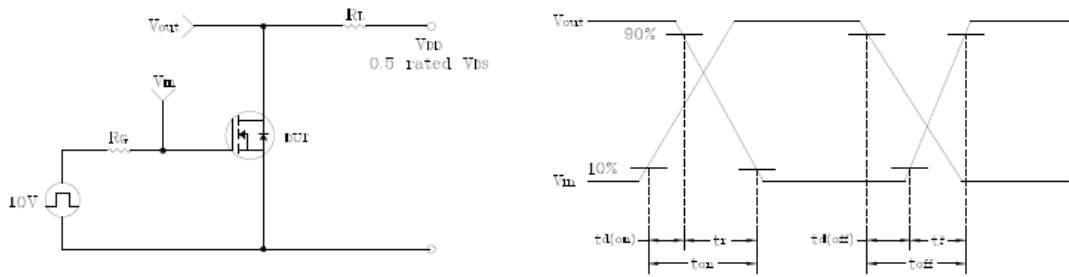

**Fig. 14 EAS Test Circuit & Waveform**

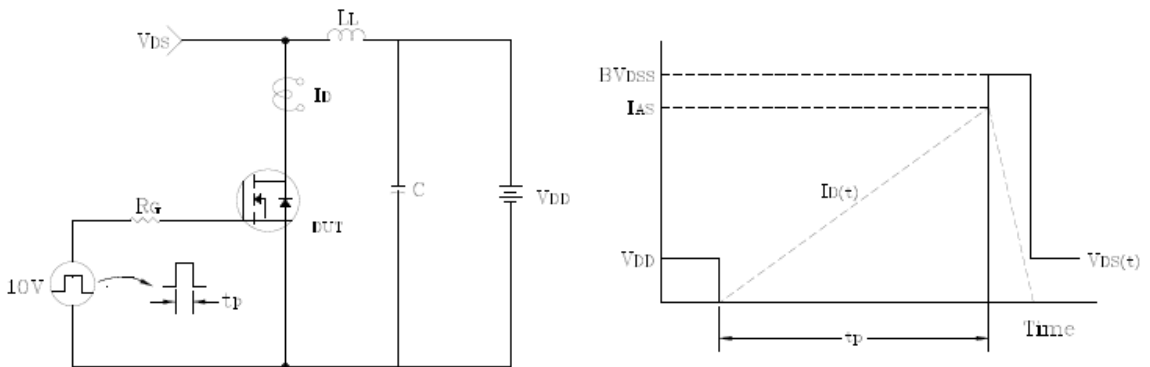
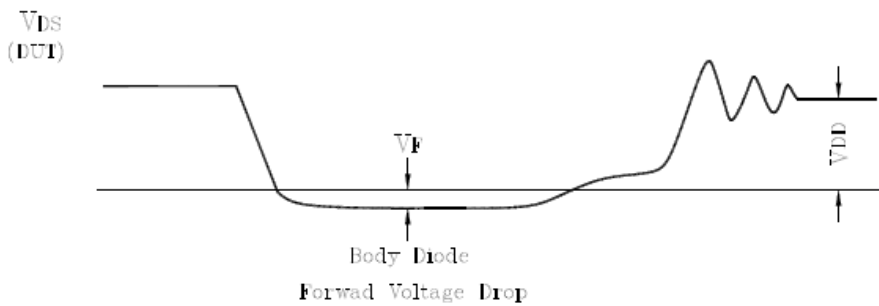
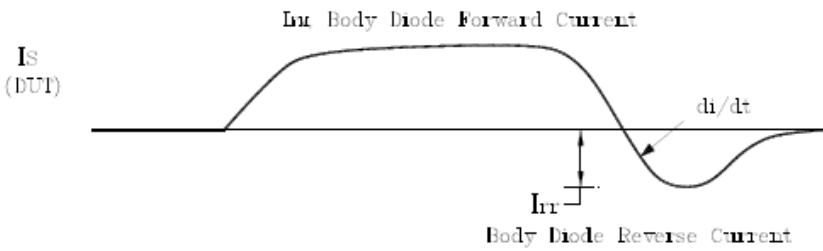
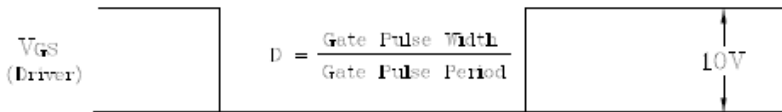
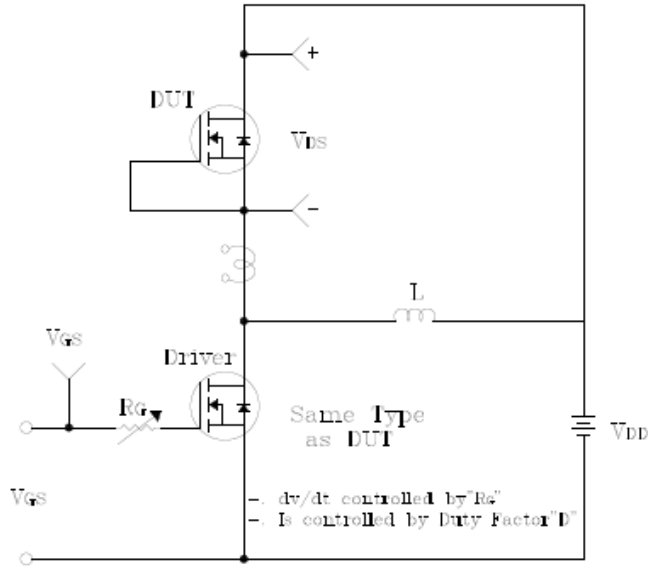

Fig. 15 Diode Reverse Recovery Time Test Circuit & Waveform



## X-ON Electronics

Largest Supplier of Electrical and Electronic Components

*Click to view similar products for [MOSFET](#) category:*

*Click to view products by [Truesemi](#) manufacturer:*

Other Similar products are found below :

[614233C](#) [648584F](#) [IRFD120](#) [IRFF430](#) [JANTX2N5237](#) [2N7000](#) [FCA20N60\\_F109](#) [FDZ595PZ](#) [AOD464](#) [2SK2267\(Q\)](#) [2SK2545\(Q,T\)](#)  
[405094E](#) [423220D](#) [MIC4420CM-TR](#) [VN1206L](#) [614234A](#) [715780A](#) [SSM6J414TU,LF\(T](#) [751625C](#) [PSMN4R2-30MLD](#)  
[TK31J60W5,S1VQ\(O](#) [2SK2614\(TE16L1,Q\)](#) [DMN1017UCP3-7](#) [EFC2J004NUZTDG](#) [FCAB21350L1](#) [P85W28HP2F-7071](#) [DMN1053UCP4-7](#)  
[NTE2384](#) [NTE2969](#) [NTE6400A](#) [DMN2080UCB4-7](#) [DMN61D9UWQ-13](#) [US6M2GTR](#) [DMN31D5UDJ-7](#) [SSM6P54TU,LF](#) [DMP22D4UFO-](#)  
[7B](#) [IPS60R3K4CEAKMA1](#) [DMN1006UCA6-7](#) [DMN16M9UCA6-7](#) [STF5N65M6](#) [STU5N65M6](#) [C3M0021120D](#) [DMN13M9UCA6-7](#)  
[BSS340NWH6327XTSA1](#) [MCM3400A-TP](#) [DMTH10H4M6SPS-13](#) [IRF40SC240ARMA1](#) [IPS60R1K0PFD7SAKMA1](#)  
[IPS60R360PFD7SAKMA1](#) [IPS60R600PFD7SAKMA1](#)