

# TSD18N20M

## 200V N-Channel MOSFET

### General Description

This Power MOSFET is produced using Truesemi's advanced planar stripe DMOS technology. This advanced technology has been especially tailored to minimize on-state resistance, provide superior switching performance, and withstand high energy pulse in the avalanche and commutation mode. These devices are well suited for high efficiency switched mode power supplies, active power factor correction based on half bridge topology.

### Features

- 18A,200V,Max. $R_{DS(on)}=0.17\ \Omega$  @  $V_{GS}=10V$
- Low gate charge(typical 22nC)
- High ruggedness
- Fast switching
- 100% avalanche tested
- Improved dv/dt capability

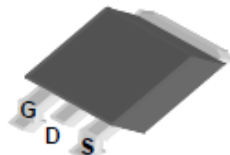

**D-PAK ( TO-252 )**

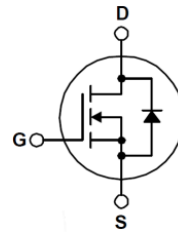

### Absolute Maximum Ratings $T_C=25^\circ\text{C}$ unless otherwise specified

Symbol	Parameter	Value	Units
$V_{DSS}$	Drain-Source Voltage	200	V
$V_{GS}$	Gate-Source Voltage	$\pm 30$	V
$I_D$	Drain Current	$T_C = 25^\circ\text{C}$	18*
		$T_C = 100^\circ\text{C}$	11.3*
$I_{DM}$	Pulsed Drain Current (Note 1)	72*	A
$I_{AS}$	Single Pulsed Avalanche Current (Note 2)	18	A
$E_{AS}$	Single Pulsed Avalanche Energy (Note 2)	453	Mj
$E_{AR}$	Repetitive Avalanche Energy (Note 1)	13.9	mJ
$I_{AR}$	Repetitive Avalanche current (Note 1)	18	A
$P_D$	Power Dissipation ( $T_C = 25^\circ\text{C}$ )	70	W
$T_J, T_{STG}$	Operating and Storage Temperature Range	-55 to +150	$^\circ\text{C}$

### Thermal Resistance Characteristics

Symbol	Parameter	Typ	Max	Units
$R_{\theta JC}$	Thermal Resistance, Junction-to-Case	--	1.79	$^\circ\text{C/W}$
$R_{\theta JA}$	Thermal Resistance, Junction-to-Ambient	--	50	$^\circ\text{C/W}$

\* Drain current limited by maximum junction temperature.

## Electrical Characteristics $T_c=25\text{ }^\circ\text{C}$ unless otherwise specified

Symbol	Parameter	Test Conditions	Min	Typ	Max	Units
--------	-----------	-----------------	-----	-----	-----	-------

### On Characteristics

$V_{GS(th)}$	Gate Threshold Voltage	$V_{DS} = V_{GS}, I_D = 250\text{ }\mu\text{A}$	2.0	--	4.0	V
$R_{DS(ON)}$	Static Drain-Source On-Resistance	$V_{GS} = 10\text{ V}, I_D = 9\text{ A}$	--	0.14	0.17	$\Omega$
$g_{fs}$	Forward transfer conductance(note 3)	$V_{DS} = 10\text{ V}, I_D = 9\text{ A}$	--	10.5	--	S

### Off Characteristics

$BV_{DSS}$	Drain-Source Breakdown Voltage	$V_{GS} = 0\text{ V}, I_D = 250\text{ }\mu\text{A}$	200	--	--	V
$I_{DSS}$	Zero Gate Voltage Drain Current	$V_{DS} = 200\text{ V}, V_{GS} = 0\text{ V}$	--	--	1	$\mu\text{A}$
		$V_{DS} = 160\text{ V}, T_c = 125\text{ }^\circ\text{C}$	--	--	100	$\mu\text{A}$
$I_{GSSF}$	Gate-Body Leakage Current, Forward	$V_{GS} = 30\text{ V}, V_{DS} = 0\text{ V}$	--	--	100	nA
$I_{GSSR}$	Gate-Body Leakage Current, Reverse	$V_{GS} = -30\text{ V}, V_{DS} = 0\text{ V}$	--	--	-100	nA

### Dynamic Characteristics

$C_{iss}$	Input Capacitance	$V_{DS} = 25\text{ V}, V_{GS} = 0\text{ V},$ $f = 1.0\text{ MHz}$	--	942	1240	pF
$C_{oss}$	Output Capacitance		--	227	310	pF
$C_{rss}$	Reverse Transfer Capacitance		--	55	71	pF

### Switching Characteristics

$t_{d(on)}$	Turn-On Time	$V_{DS} = 125\text{ V}, I_D = 18\text{ A},$ $R_G = 25\text{ }\Omega$  (Note 3,4)	--	15	--	ns
$t_r$	Turn-On Rise Time		--	130	--	ns
$t_{d(off)}$	Turn-Off Delay Time		--	135	--	ns
$t_f$	Turn-Off Fall Time		--	105	--	ns
$Q_g$	Total Gate Charge	$V_{DS} = 160\text{ V}, I_D = 18\text{ A},$ $V_{GS} = 10\text{ V}$  (Note 3,4)	--	22	28	nC
$Q_{gs}$	Gate-Source Charge		--	6.6	--	nC
$Q_{gd}$	Gate-Drain Charge		--	7.2	--	nC

### Source-Drain Diode Maximum Ratings and Characteristics

$I_S$	Continuous Source-Drain Diode Forward Current	--	--	18	A	
$I_{SM}$	Pulsed Source-Drain Diode Forward Current (Note 4)	--	--	72		
$V_{SD}$	Source-Drain Diode Forward Voltage	$I_S = 18\text{ A}, V_{GS} = 0\text{ V}$ (Note 4)	--	--	1.4	V
$t_{rr}$	Reverse Recovery Time	$I_S = 18\text{ A}, V_{GS} = 0\text{ V}$ $di_F/dt = 100\text{ A}/\mu\text{s}$	--	208	--	ns
$Q_{rr}$	Reverse Recovery Charge		--	1.63	--	$\mu\text{C}$

#### NOTES:

1. Repetitive Rating: Pulse width limited by maximum junction temperature
2.  $L=2.1\text{ mH}, I_{AS}=18\text{ A}, V_{DD}=50\text{ V}, R_G=25\text{ }\Omega,$  Starting  $T_J=25\text{ }^\circ\text{C}$
3. Pulse Test: Pulse width  $\leq 300\mu\text{s}$ , Duty Cycle  $\leq 2\%$
4. Essentially Independent of Operating Temperature Typical Characteristics

# Typical Characteristics

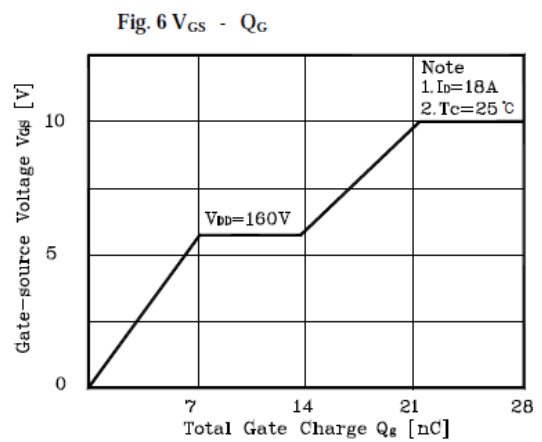
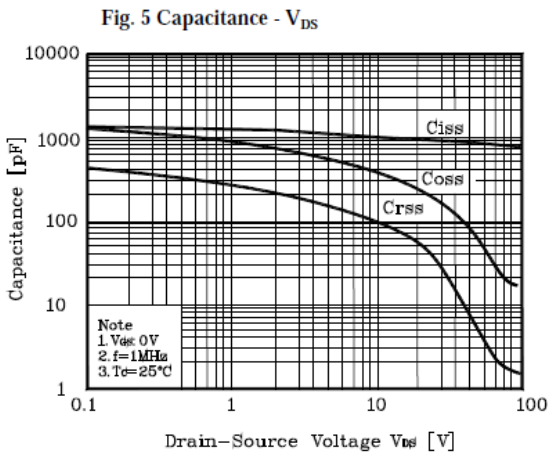
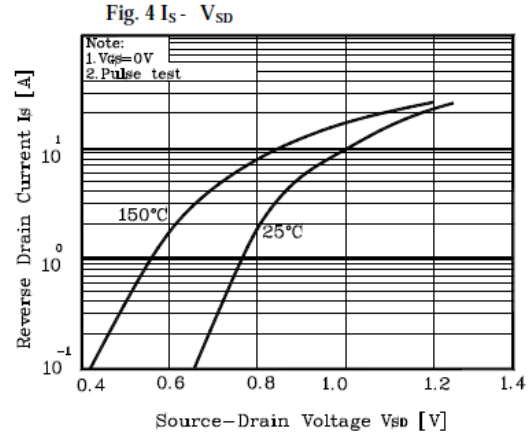
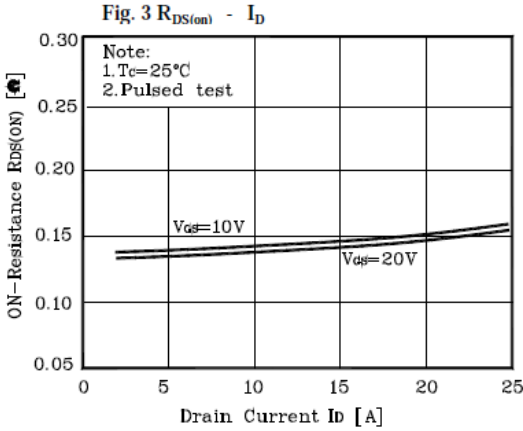
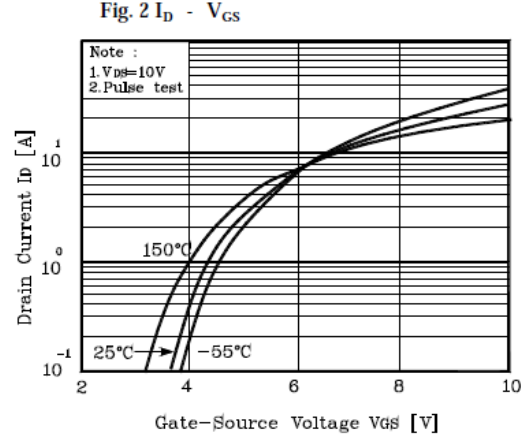
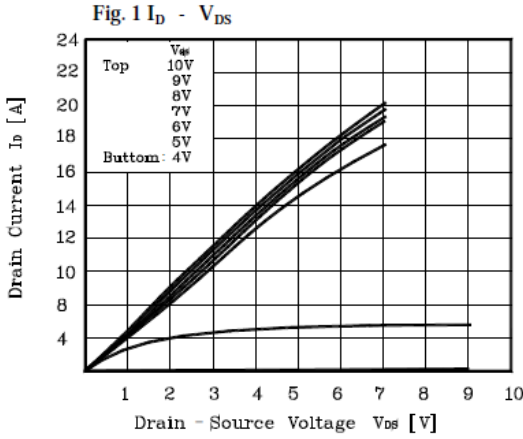

Typical Characteristics

Fig. 7  $V_{DSS} - T_J$

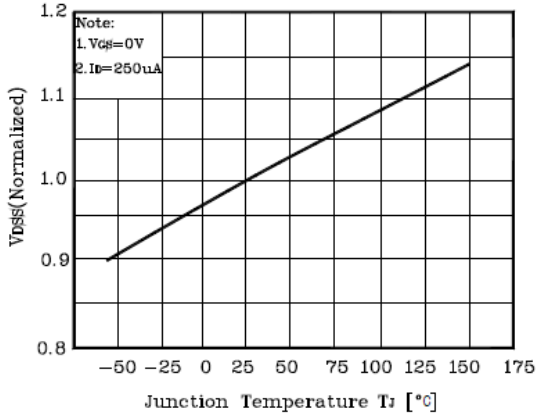

Fig. 8  $R_{DS(on)} - T_J$

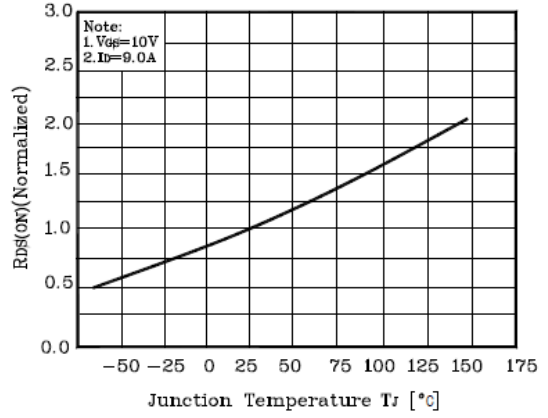

Fig. 9  $I_D - T_C$

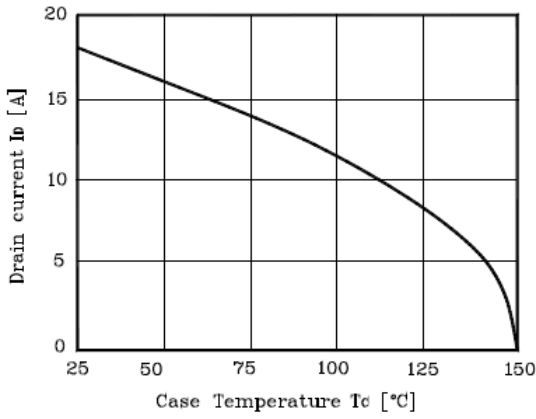

Fig. 10 Safe Operating Area

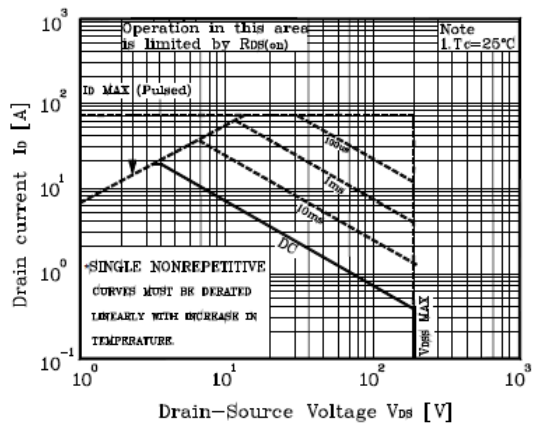

Fig 11. Gate Charge Test Circuit & Waveform

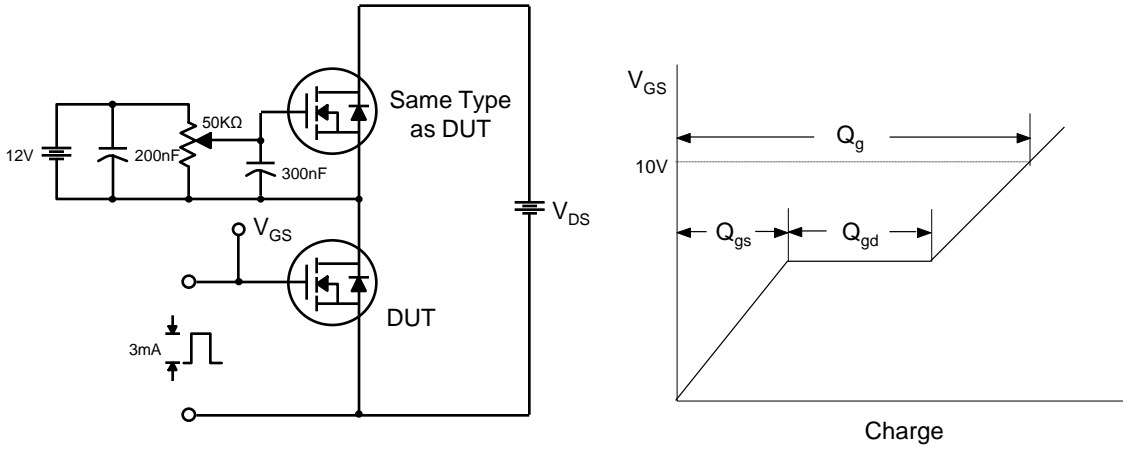

Fig 12. Resistive Switching Test Circuit & Waveforms

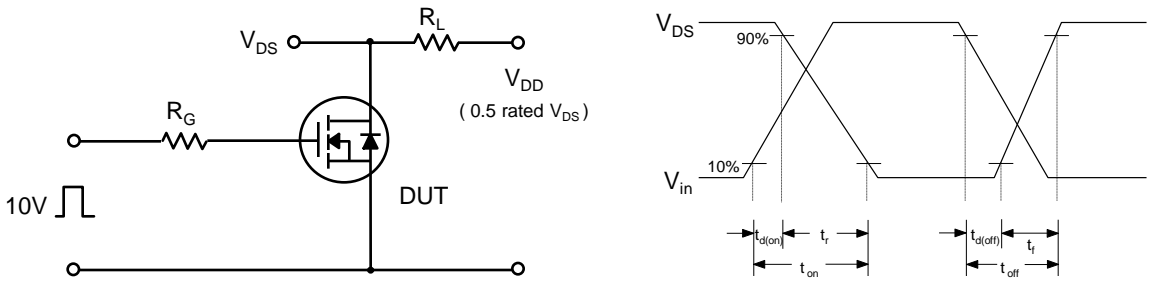

Fig 13. Unclamped Inductive Switching Test Circuit & Waveforms

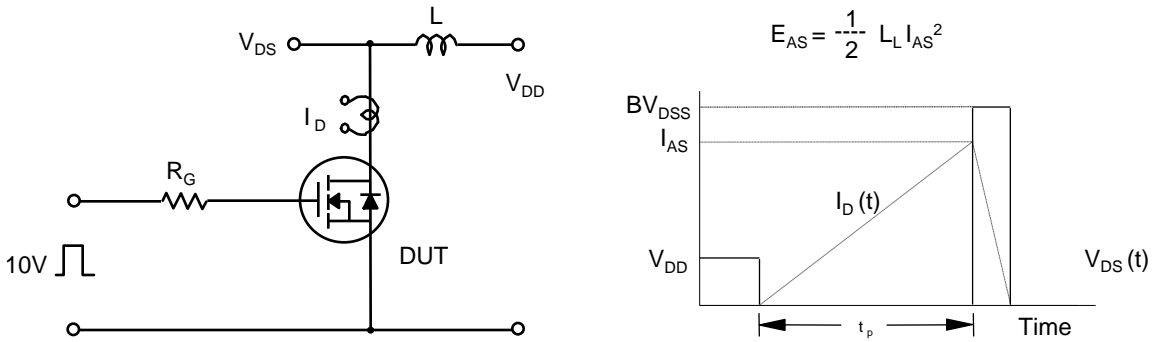
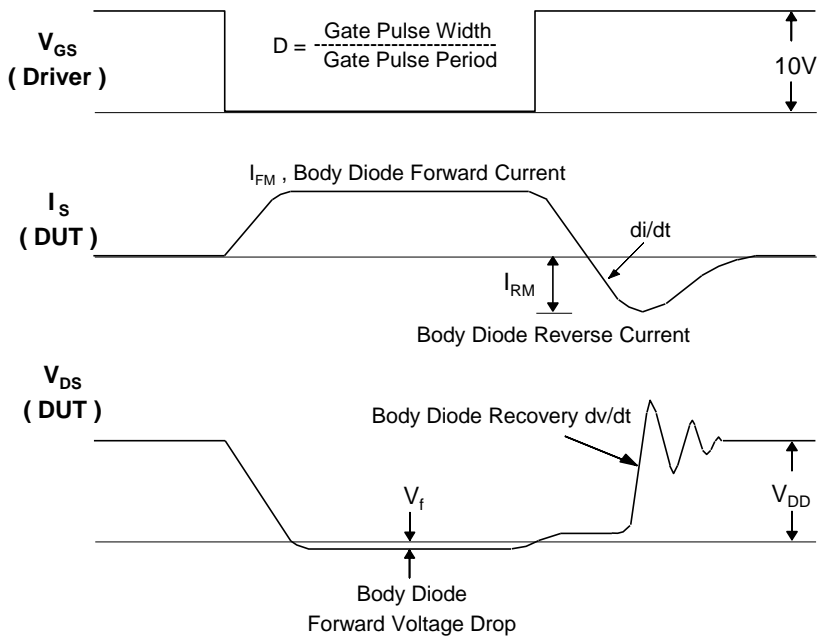
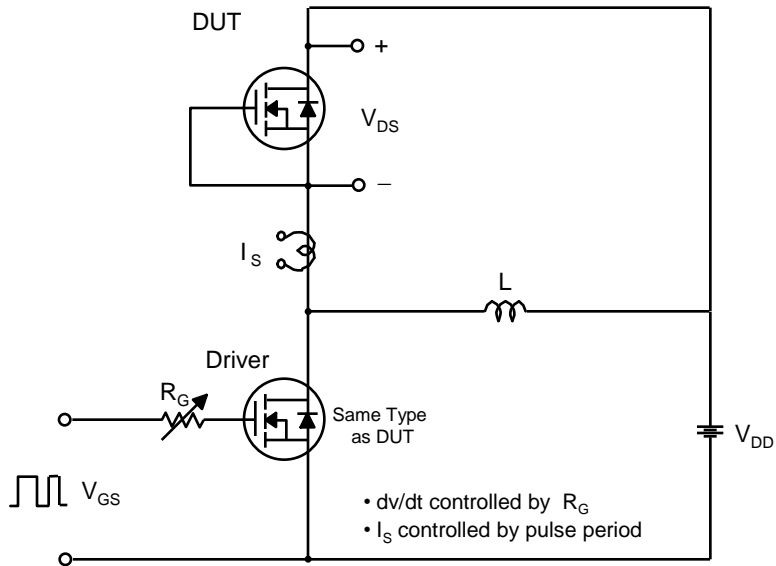

Fig 14. Peak Diode Recovery dv/dt Test Circuit & Waveforms



## X-ON Electronics

Largest Supplier of Electrical and Electronic Components

*Click to view similar products for [MOSFET](#) category:*

*Click to view products by [Truesemi](#) manufacturer:*

Other Similar products are found below :

[614233C](#) [648584F](#) [IRFD120](#) [IRFF430](#) [JANTX2N5237](#) [2N7000](#) [FCA20N60\\_F109](#) [FDZ595PZ](#) [AOD464](#) [2SK2267\(Q\)](#) [2SK2545\(Q,T\)](#)  
[405094E](#) [423220D](#) [MIC4420CM-TR](#) [VN1206L](#) [614234A](#) [715780A](#) [SSM6J414TU,LF\(T](#) [751625C](#) [BSC884N03MS G](#) [BSF024N03LT3 G](#)  
[PSMN4R2-30MLD](#) [TK31J60W5,S1VQ\(O](#) [2SK2614\(TE16L1,Q\)](#) [DMN1017UCP3-7](#) [EFC2J004NUZTDG](#) [FCAB21350L1](#) [P85W28HP2F-](#)  
[7071](#) [DMN1053UCP4-7](#) [NTE2384](#) [NTE2969](#) [NTE6400A](#) [DMN2080UCB4-7](#) [DMN61D9UWQ-13](#) [US6M2GTR](#) [DMN31D5UDJ-7](#)  
[SSM6P54TU,LF](#) [DMP22D4UFO-7B](#) [IPS60R3K4CEAKMA1](#) [DMN1006UCA6-7](#) [DMN16M9UCA6-7](#) [STF5N65M6](#) [STU5N65M6](#)  
[C3M0021120D](#) [DMN13M9UCA6-7](#) [BSS340NWH6327XTSA1](#) [MCM3400A-TP](#) [DMTH10H4M6SPS-13](#) [IRF40SC240ARMA1](#)  
[IPS60R1K0PFD7SAKMA1](#)