



TSK50N30M

300V N-Channel MOSFET

Features

This Power MOSFET is produced using Truesemi's advanced planar stripe DMOS technology. This advanced technology has been especially tailored to minimize on-state resistance, provide superior switching performance, and withstand high energy pulse in the avalanche and commutation mode.

- 50A,300V,Max.RDS(on)=0.06Ω @ VGS =10V
- Drain-Source breakdown voltage: BVDSS=300V (Min.)
- Low gate charge: Qg=122nC (Typ.)
- 100% avalanche tested
- RoHS compliant device

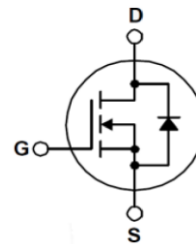
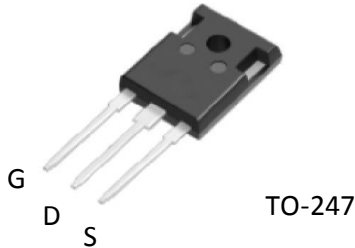

Absolute Maximum Ratings Tc=25°C unless otherwise specified

Symbol	Parameter	Value	Units	
V _{DSS}	Drain-Source Voltage	300	V	
V _{GS}	Gate-Source Voltage	± 30	V	
I _D	Drain Current	T _C = 25°C	50	A
		T _C = 100°C	31	A
I _{DM}	Pulsed Drain Current (Note 1)	200	A	
E _{AS}	Single Pulsed Avalanche Energy (Note 2)	1875	mJ	
I _{AS}	Single avalanche current (Note 2)	25	A	
E _{AR}	Repetitive Avalanche Energy (Note 1)	19.80	mJ	
P _D	Power Dissipation (T _C = 25°C)	198	W	
T _J	Junction temperature	150	°C	
T _{stg}	Storage temperature range	-55~150	°C	

Thermal Resistance Characteristics

Symbol	Parameter	Typ.	Max.	Units
R _{θJC}	Thermal Resistance,Junction-to-Case	--	0.63	°C/W
R _{θJA}	Thermal Resistance,Junction-to-Ambient	--	62.5	°C/W

Electrical Characteristics $T_c=25\text{ }^\circ\text{C}$ unless otherwise specified

Symbol	Parameter	Test Conditions	Min	Typ	Max	Units
--------	-----------	-----------------	-----	-----	-----	-------

On Characteristics

$V_{GS(th)}$	Gate Threshold Voltage	$V_{DS} = V_{GS}, I_D = 250\text{ }\mu\text{A}$	2.0	--	4.0	V
$R_{DS(ON)}$	Static Drain-Source On-Resistance	$V_{GS} = 10\text{ V}, I_D = 25\text{ A}$	--	0.05	0.06	Ω
R_g	Internal gate resistance	Open drain, $f=1\text{ MHz}$	--	1	--	Ω

Off Characteristics

BV_{DSS}	Drain-Source Breakdown Voltage	$V_{GS} = 0\text{ V}, I_D = 250\text{ }\mu\text{A}$	300	--	--	V
I_{DSS}	Drain-source cut-off current	$V_{DS} = 300\text{ V}, V_{GS} = 0\text{ V}$	--	--	1	μA
		$V_{DS}=300\text{ V}, T_c=125\text{ }^\circ\text{C}$	--	--	100	μA
I_{GSS}	Gate leakage current	$V_{DS}=0\text{ V}, V_{GS}=\pm 30\text{ V}$	--	--	± 100	Na

Dynamic Characteristics

C_{iss}	Input Capacitance	$V_{DS} = 25\text{ V}, V_{GS} = 0\text{ V},$ $f = 1.0\text{ MHz}$	--	5490	--	pF
C_{oss}	Output Capacitance		--	600	--	pF
C_{riss}	Reverse Transfer Capacitance		--	65	--	pF

Switching Characteristics

$t_{d(on)}$	Turn-On Time (Note 3,4)	$V_{DD} = 150\text{ V}, I_D = 50\text{ A},$ $R_G = 25\text{ }\Omega$	--	71	--	ns
t_r	Turn-On Rise Time (Note 3,4)		--	35	--	ns
$t_{d(off)}$	Turn-Off Delay Time (Note 4,5)		--	324	--	ns
t_f	Turn-Off Fall Time (Note 3,4)		--	51	--	ns
Q_g	Total Gate Charge (Note 3,4)	$V_{DS}=240\text{ V}, I_D = 50\text{ A},$ $V_{GS} = 10\text{ V}$	--	122	--	nC
Q_{gs}	Gate-Source Charge (Note 3,4)		--	28	--	nC
Q_{gd}	Gate-Drain Charge (Note 3,4)		--	42	--	nC

Source-Drain Diode Maximum Ratings and Characteristics

I_S	Continuous Source-Drain Diode Forward Current	--	--	50	A	
I_{SM}	Pulsed Source-Drain Diode Forward Current	--	--	200		
V_{SD}	Source-Drain Diode Forward Voltage	$I_S = 50\text{ A}, V_{GS} = 0\text{ V}$	--	--	1.5	V
t_{rr}	Reverse Recovery Time	$I_S = 50\text{ A}, V_{GS} = 0\text{ V}$ $di_r/dt = 100\text{ A}/\mu\text{s}$	--	318	--	ns
Q_{rr}	Reverse Recovery Charge	(Note 3, 4)	--	3.4	--	μC

NOTES:

1. Repeated rating: Pulse width limited by safe operating area
2. $L=5\text{ mH}, I_{AS}=25\text{ A}, V_{DD}=50\text{ V}, R_G=25\text{ }\Omega$, Starting $T_J=25\text{ }^\circ\text{C}$
3. Pulse test: Pulse width $\leq 300\text{ }\mu\text{s}$, Duty cycle $\leq 2\%$
4. Essentially independent of operating temperature typical characteristics

Typical Characteristics Curve

Fig. 1 $I_D - V_{DS}$

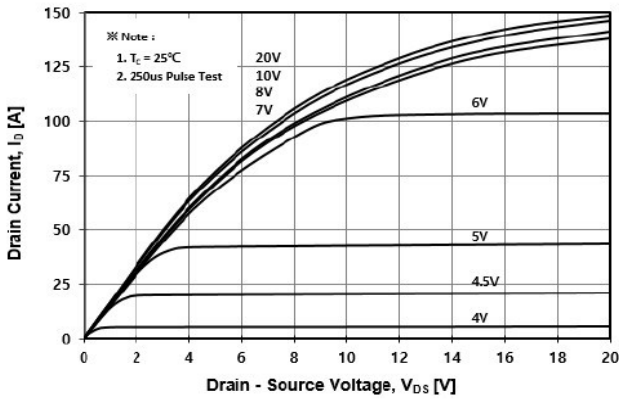

Fig. 2 $I_D - V_{GS}$

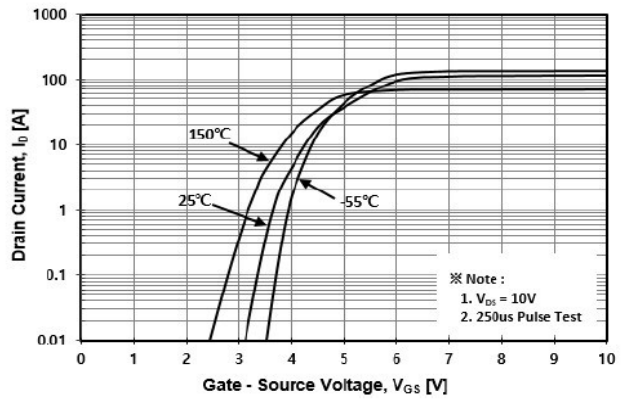

Fig. 3 $R_{DS(ON)} - I_D$

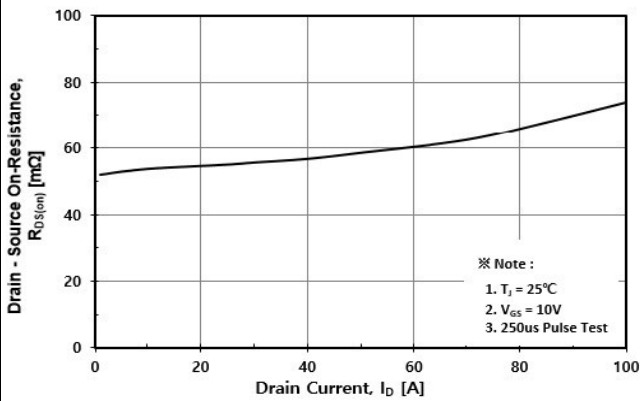

Fig. 4 $I_S - V_{SD}$

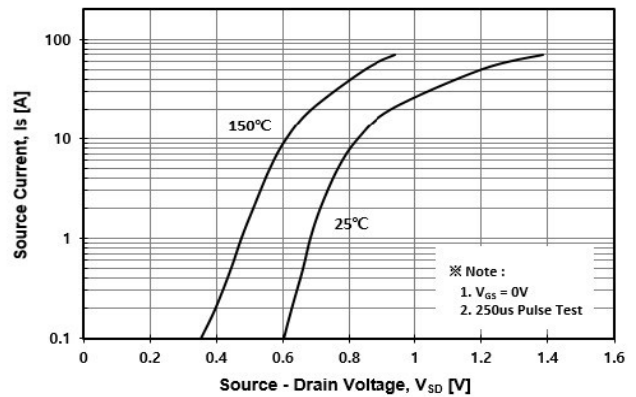

Fig. 5 Capacitance - V_{DS}

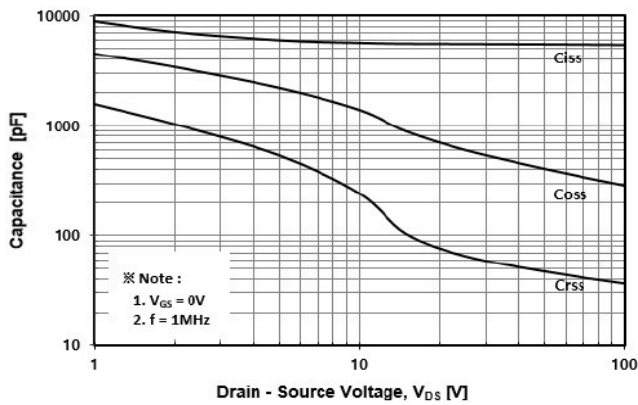
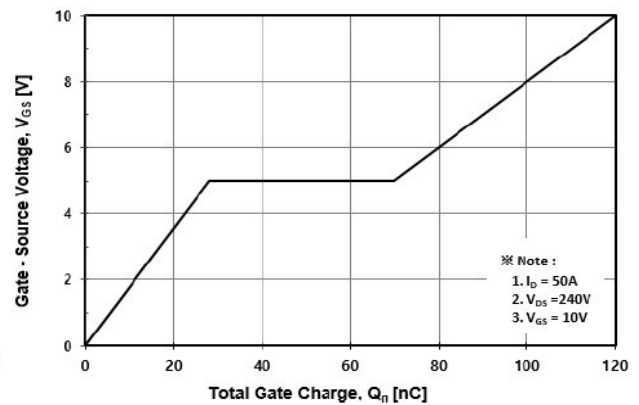

Fig. 6 $V_{GS} - Q_G$



Typical Characteristics Curve (Continue)

Fig. 7 $BV_{DSS} - T_J$

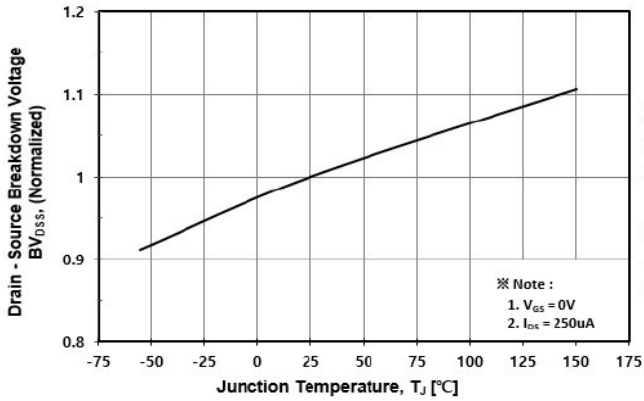

Fig. 8 $R_{DS(ON)} - T_J$

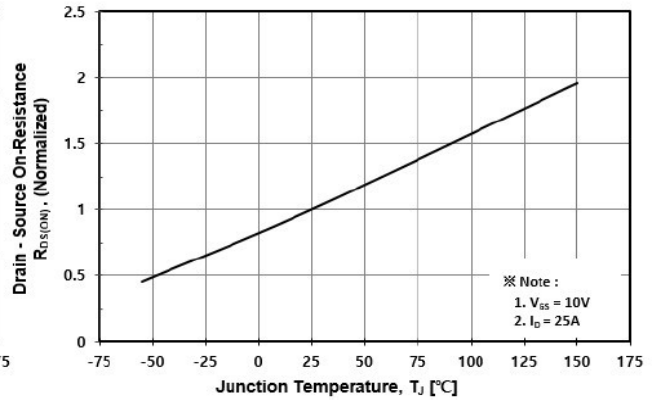

Fig. 9 $I_D - T_C$

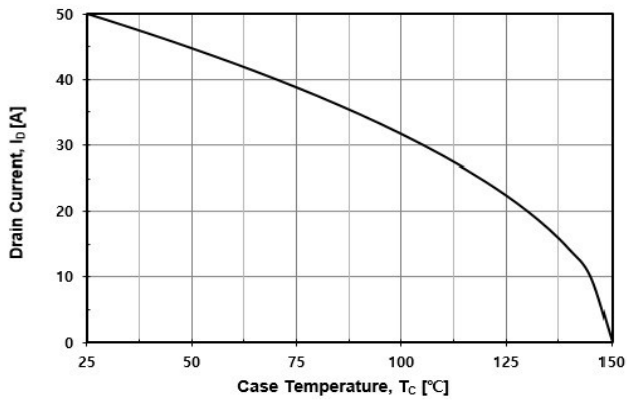

Fig. 10 Safe Operating Area

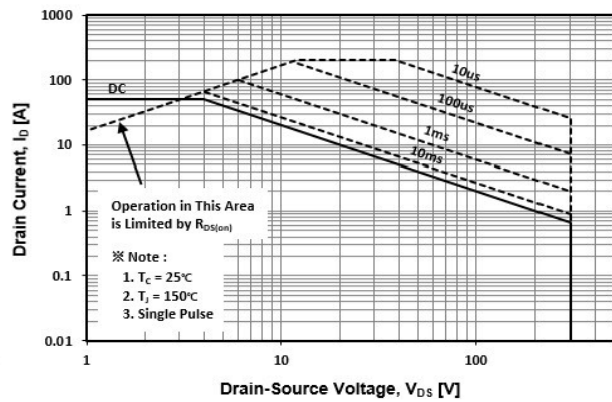

Fig. 11 Transient Thermal Impedance

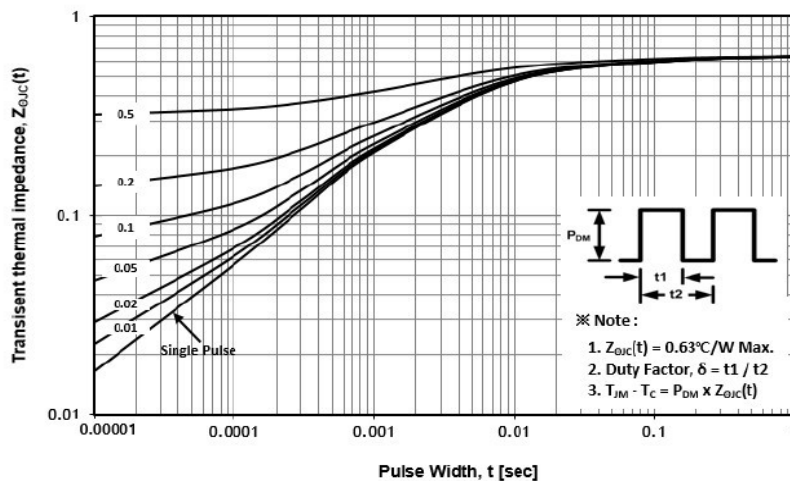

Fig. 12 Gate Charge Test Circuit & Waveform

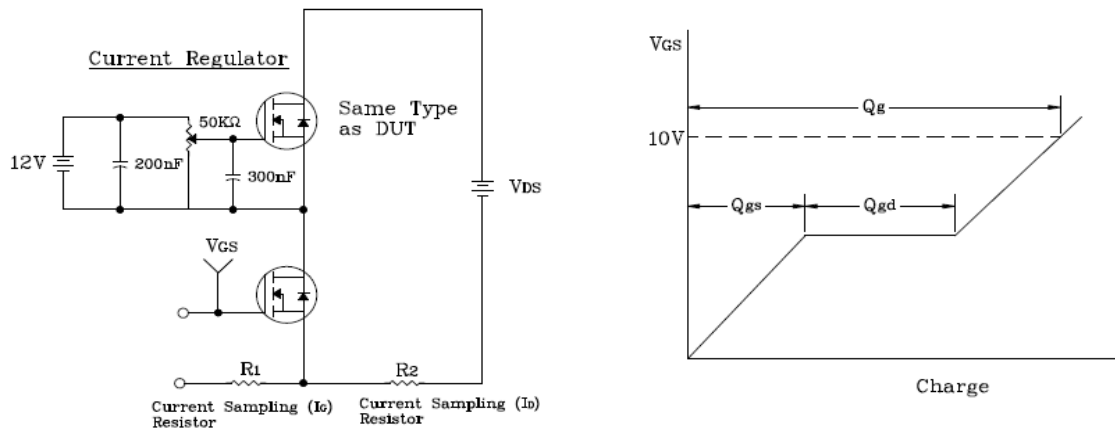

Fig. 13 Resistive Switching Test Circuit & Waveform

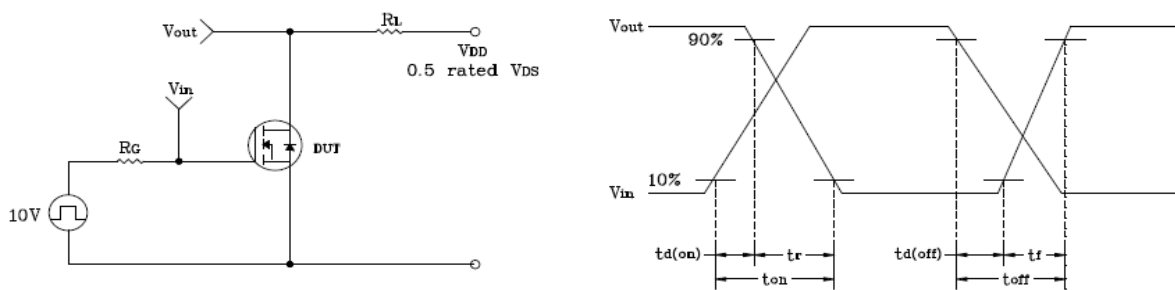

Fig. 14 E_{AS} Test Circuit & Waveform

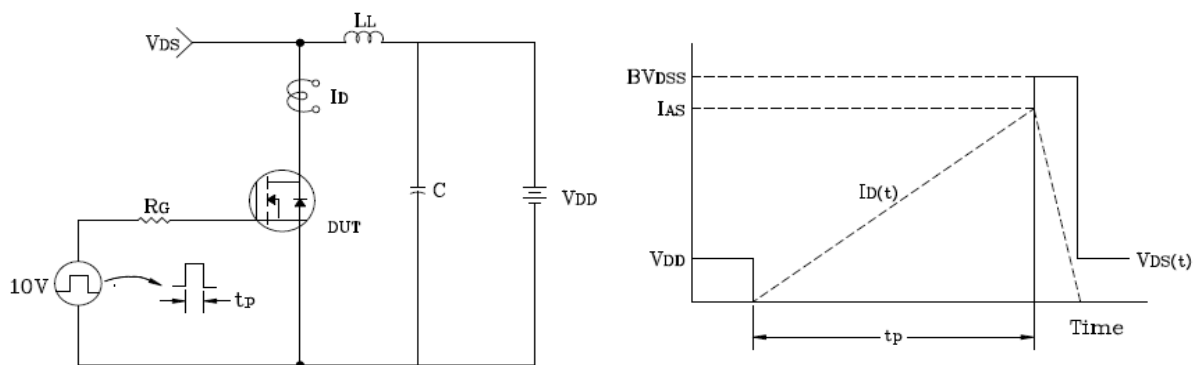
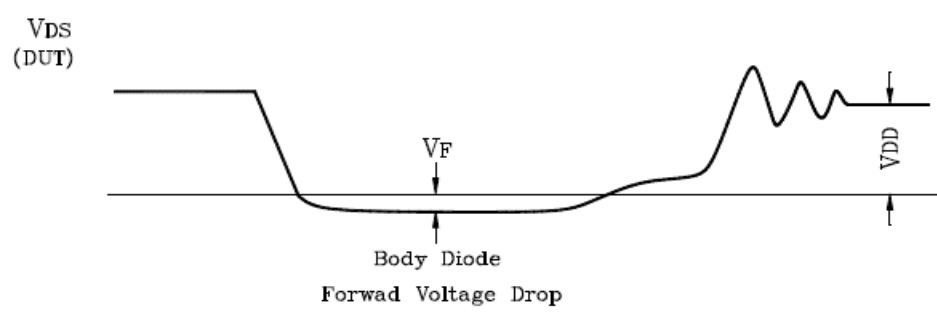
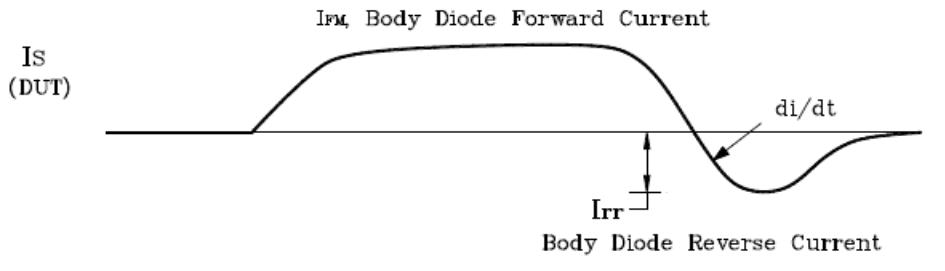
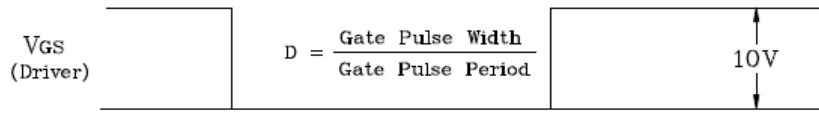
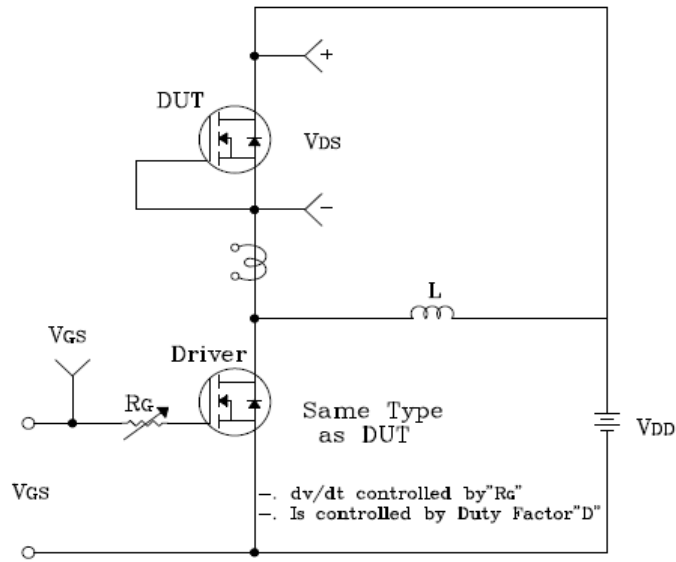

Fig. 15 Diode Reverse Recovery Time Test Circuit & Waveform



X-ON Electronics

Largest Supplier of Electrical and Electronic Components

Click to view similar products for [MOSFET](#) category:

Click to view products by [Truesemi](#) manufacturer:

Other Similar products are found below :

[IRFD120](#) [JANTX2N5237](#) [BUK455-60A/B](#) [MIC4420CM-TR](#) [VN1206L](#) [NDP4060](#) [SI4482DY](#) [IPS70R2K0CEAKMA1](#) [SQD23N06-31L-GE3](#)
[TK16J60W,S1VQ\(O](#) [2SK2614\(TE16L1,Q\)](#) [DMN1017UCP3-7](#) [DMN1053UCP4-7](#) [SQJ469EP-T1-GE3](#) [NTE2384](#) [DMC2700UDMQ-7](#)
[DMN2080UCB4-7](#) [DMN61D9UWQ-13](#) [US6M2GTR](#) [DMN31D5UDJ-7](#) [DMP22D4UFO-7B](#) [DMN1006UCA6-7](#) [DMN16M9UCA6-7](#)
[STF5N65M6](#) [IRF40H233XTMA1](#) [STU5N65M6](#) [DMN6022SSD-13](#) [DMN13M9UCA6-7](#) [DMTH10H4M6SPS-13](#) [DMN2990UFB-7B](#)
[IPB80P04P405ATMA2](#) [2N7002W-G](#) [MCAC30N06Y-TP](#) [MCQ7328-TP](#) [BXP7N65D](#) [BXP4N65F](#) [AOL1454G](#) [WMJ80N60C4](#) [BXP2N20L](#)
[BXP2N65D](#) [BXT1150N10J](#) [BXT1700P06M](#) [TSM60NB380CP](#) [ROG](#) [RQ7L055BGTCR](#) [DMNH15H110SK3-13](#) [SLF10N65ABV2](#)
[BSO203SP](#) [BSO211P](#) [IPA60R230P6](#) [IPA60R460CE](#)