

TSP16N25M

250V N-Channel MOSFET

General Description

This Power MOSFET is produced using Truesemi's advanced planar stripe DMOS technology. This advanced technology has been especially tailored to minimize on-state resistance, provide superior switching performance, and withstand high energy pulse in the avalanche and commutation mode. These devices are well suited for high efficiency switched mode power supplies, active power factor correction based on half bridge topology.

Features

- 16A,250V,Max. $R_{DS(on)}=0.25\Omega @ V_{GS} =10V$

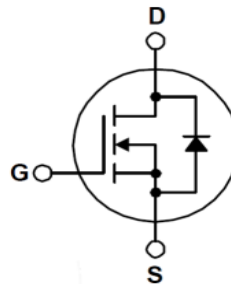
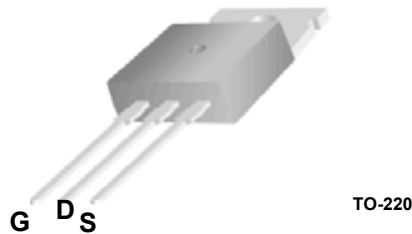

Absolute maximum ratings ($T_C=25^\circ\text{C}$ unless otherwise noted)

Characteristic	Symbol	Rating	Unit	
Drain-source voltage	V_{DSS}	250	V	
Gate-source voltage	V_{GSS}	± 30	V	
Drain current (DC) *	I_D	$T_C=25^\circ\text{C}$	16	A
		$T_C=100^\circ\text{C}$	7.2	A
Drain current (Pulsed) *	I_{DM}	64	A	
Power dissipation	P_D	85	W	
Avalanche current (Single) ②	I_{AS}	16	A	
Single pulsed avalanche energy ②	E_{AS}	480	mJ	
Avalanche current (Repetitive) ①	I_{AR}	16	A	
Repetitive avalanche energy ①	E_{AR}	13.9	mJ	
Junction temperature	T_J	150	°C	
Storage temperature range	T_{stg}	-55~150		

* Limited by maximum junction temperature

Characteristic	Symbol	Typ.	Max.	Unit
Thermal resistance	Junction-case	-	1.47	°C/W
	Junction-ambient	-	62.5	

Electrical Characteristics ($T_C=25^\circ\text{C}$ unless otherwise noted)

Characteristic	Symbol	Test Condition	Min.	Typ.	Max.	Unit
Drain-source breakdown voltage	BV_{DSS}	$I_D=250\mu\text{A}$, $V_{GS}=0\text{V}$	250	-	-	V
Gate threshold voltage	$V_{GS(th)}$	$I_D=250\mu\text{A}$, $V_{DS}=V_{GS}$	2.0	-	4.0	V
Drain-source cut-off current	I_{DSS}	$V_{DS}=250\text{V}$, $V_{GS}=0\text{V}$	-	-	1	μA
Gate leakage current	I_{GSS}	$V_{DS}=0\text{V}$, $V_{GS}=\pm 30\text{V}$	-	-	± 100	nA
Drain-source on-resistance ④	$R_{DS(on)}$	$V_{GS}=10\text{V}$, $I_D=8.0\text{A}$	-	0.22	0.25	Ω
Forward transfer conductance ④	g_{fs}	$V_{DS}=10\text{V}$, $I_D=8.0\text{A}$	-	10.5	-	S
Input capacitance	C_{iss}	$V_{GS}=0\text{V}$, $V_{DS}=25\text{V}$ $f=1\text{ MHz}$	-	968	1275	pF
Output capacitance	C_{oss}		-	204	278	
Reverse transfer capacitance	C_{rss}		-	49	64	
Turn-on delay time	$t_{d(on)}$	$V_{DD}=125\text{V}$, $I_D=16\text{A}$ $R_G=25\Omega$ ③④	-	15	-	ns
Rise time	t_r		-	45	-	
Turn-off delay time	$t_{d(off)}$		-	50	-	
Fall time	t_f		-	50	-	
Total gate charge	Q_g	$V_{DS}=200\text{V}$, $V_{GS}=10\text{V}$ $I_D=16\text{A}$ ③④	-	45	50	nC
Gate-source charge	Q_{gs}		-	7.1	-	
Gate-drain charge	Q_{gd}		-	5.9	-	

Source-Drain Diode Ratings and Characteristics ($T_C=25^\circ\text{C}$ unless otherwise noted)

Characteristic	Symbol	Test Condition	Min.	Typ.	Max.	Unit
Source current (DC)	I_S	Integral reverse diode in the MOSFET	-	-	16	A
Source current (Pulsed) ①	I_{SM}		-	-	64	
Forward voltage ④	V_{SD}	$V_{GS}=0\text{V}$, $I_S=16\text{A}$	-	-	1.4	V
Reverse recovery time	t_{rr}	$I_S=16\text{A}$, $V_{GS}=0\text{V}$ $dI_F/dt=100\text{A}/\mu\text{s}$	-	208	-	ns
Reverse recovery charge	Q_{rr}		-	2.63	-	μC

Note ;

- ① Repetitive rating : Pulse width limited by maximum junction temperature
- ② $L=3.0\text{mH}$, $I_{AS}=16\text{A}$, $V_{DD}=50\text{V}$, $R_G=25\Omega$, Starting $T_J=25^\circ\text{C}$
- ③ Pulse Test : Pulse width $\leq 300\mu\text{s}$, Duty cycle $\leq 2\%$
- ④ Essentially independent of operating temperature

Electrical Characteristic Curves

Fig. 1 $I_D - V_{DS}$

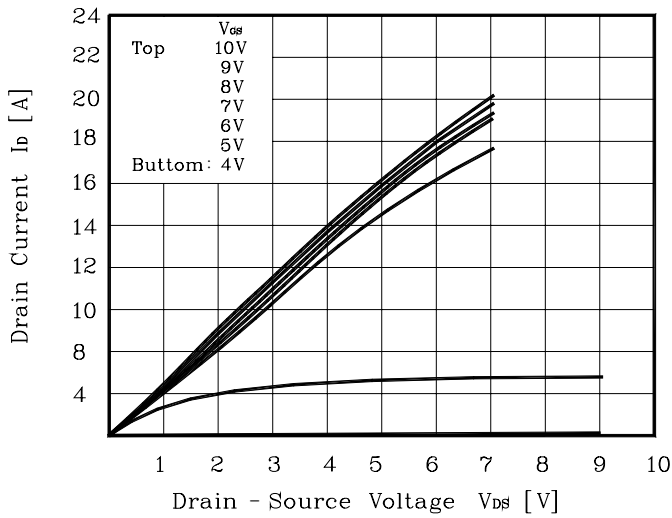

Fig. 2 $I_D - V_{GS}$

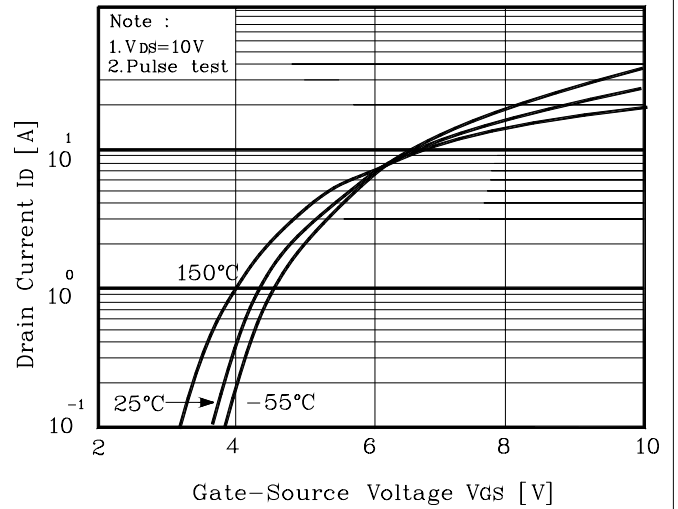

Fig. 3 $R_{DS(on)} - I_D$

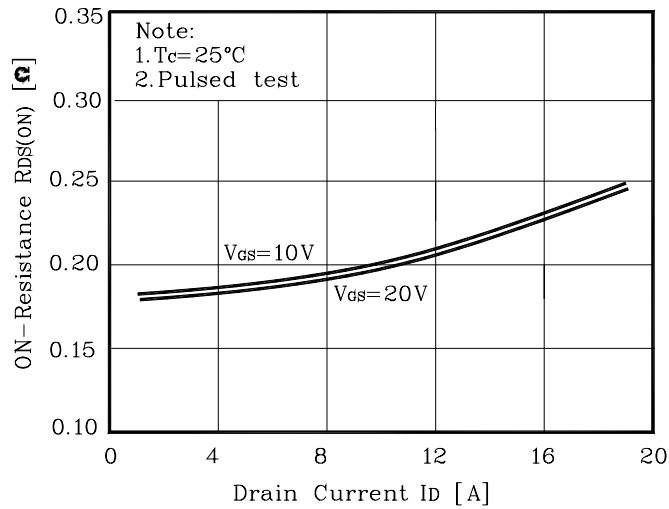

Fig. 4 $I_S - V_{SD}$

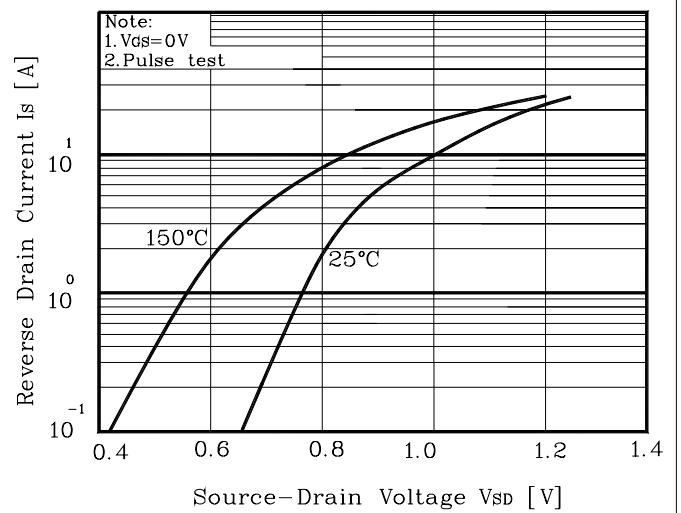

Fig. 5 Capacitance - V_{DS}

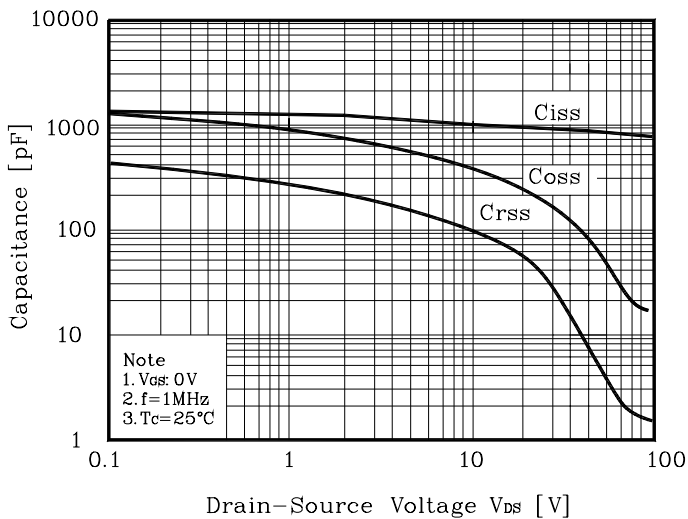

Fig. 6 $V_{GS} - Q_G$

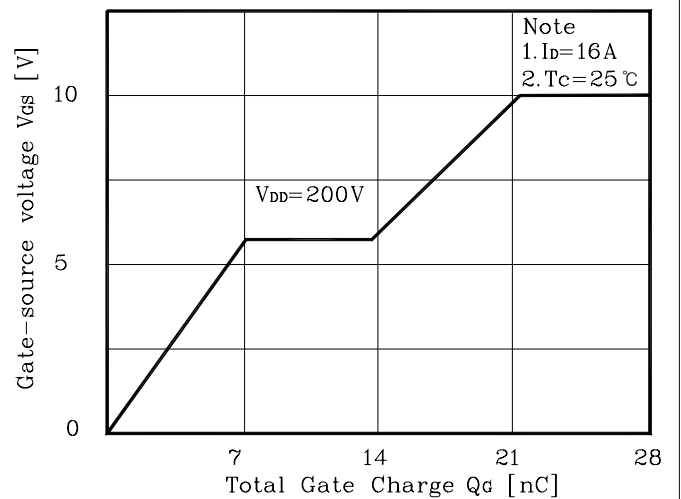

Fig. 7 $V_{DSS} - T_J$

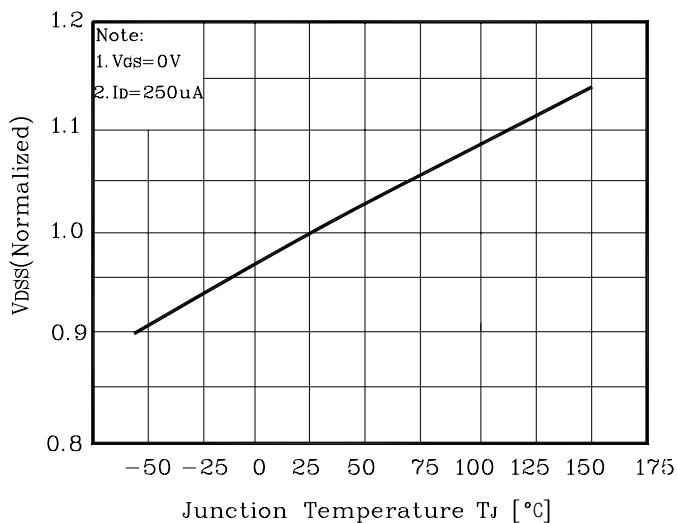

Fig. 8 $R_{DS(on)} - T_J$

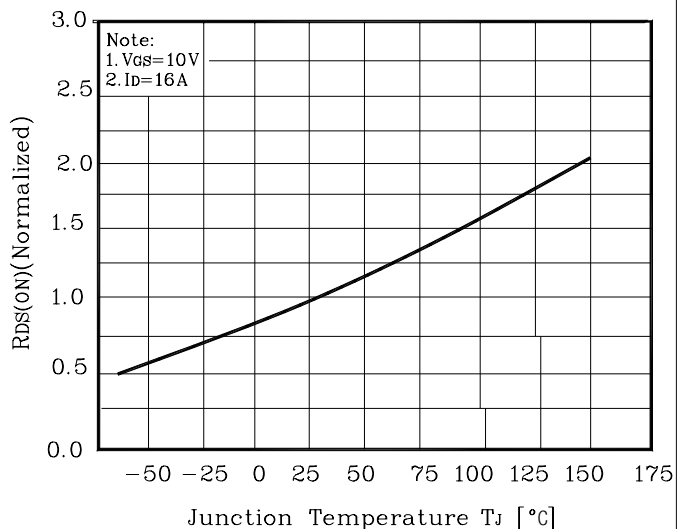

Fig. 9 $I_D - T_C$

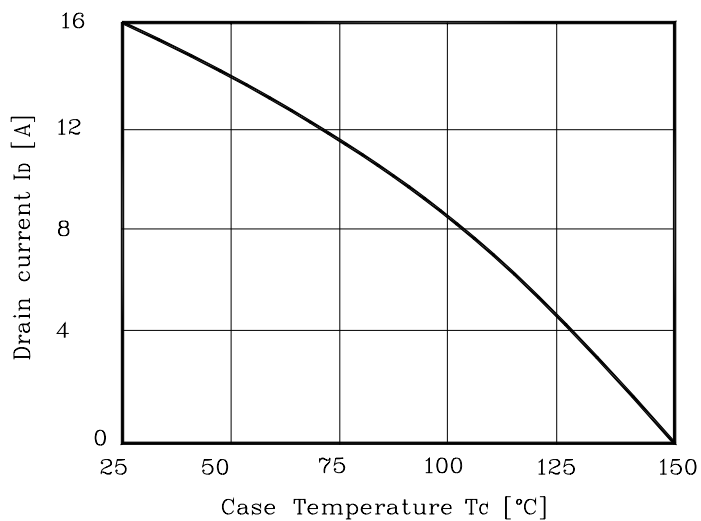

Fig. 10 Safe Operating Area

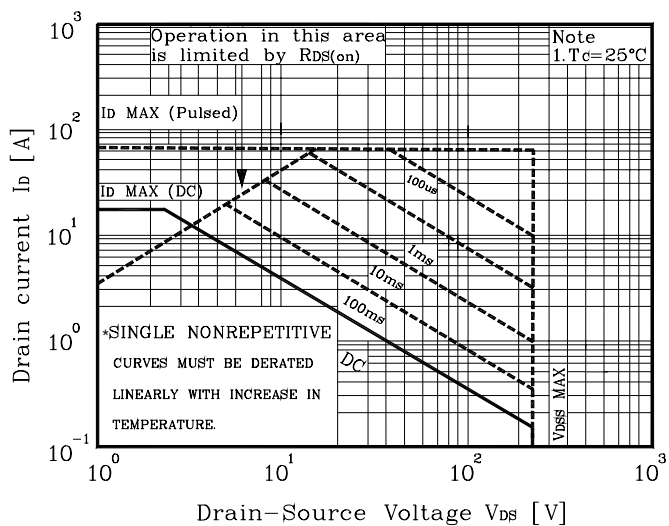

Fig. 11 Gate Charge Test Circuit & Waveform

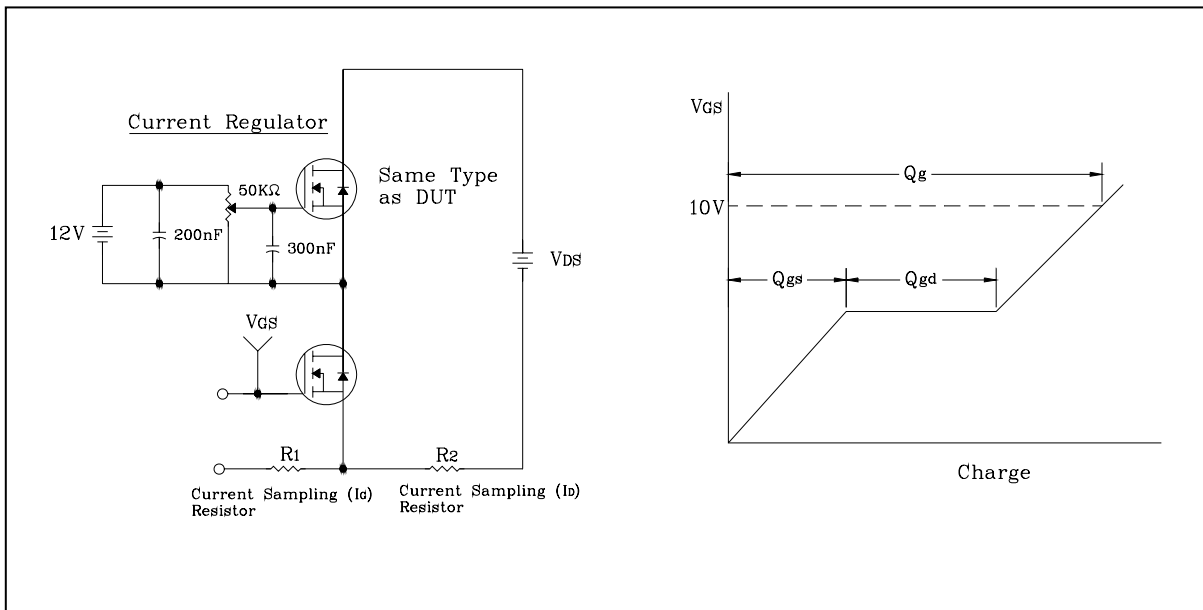

Fig. 12 Resistive Switching Test Circuit & Waveform

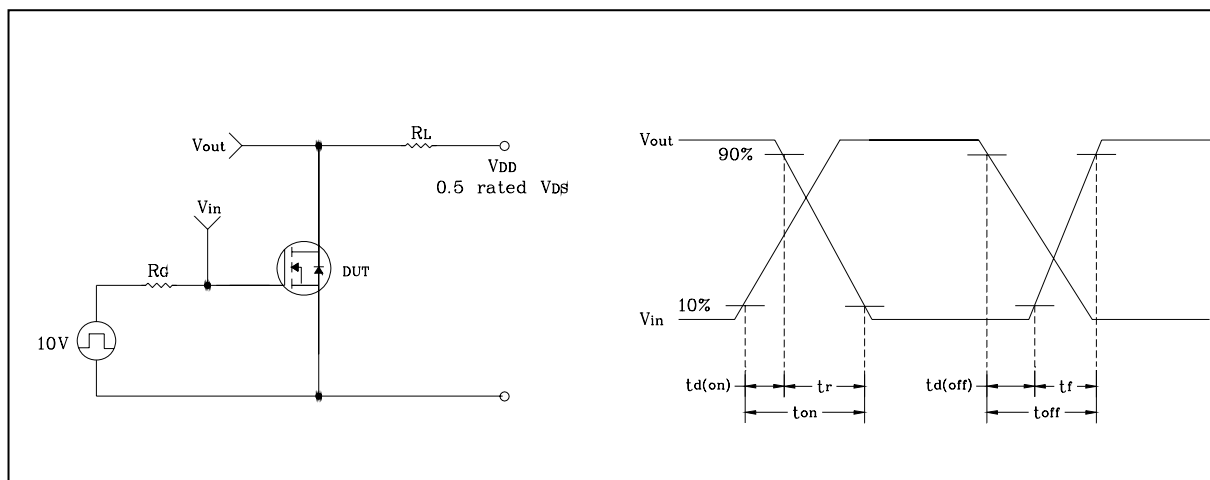

Fig. 13 E_{AS} Test Circuit & Waveform

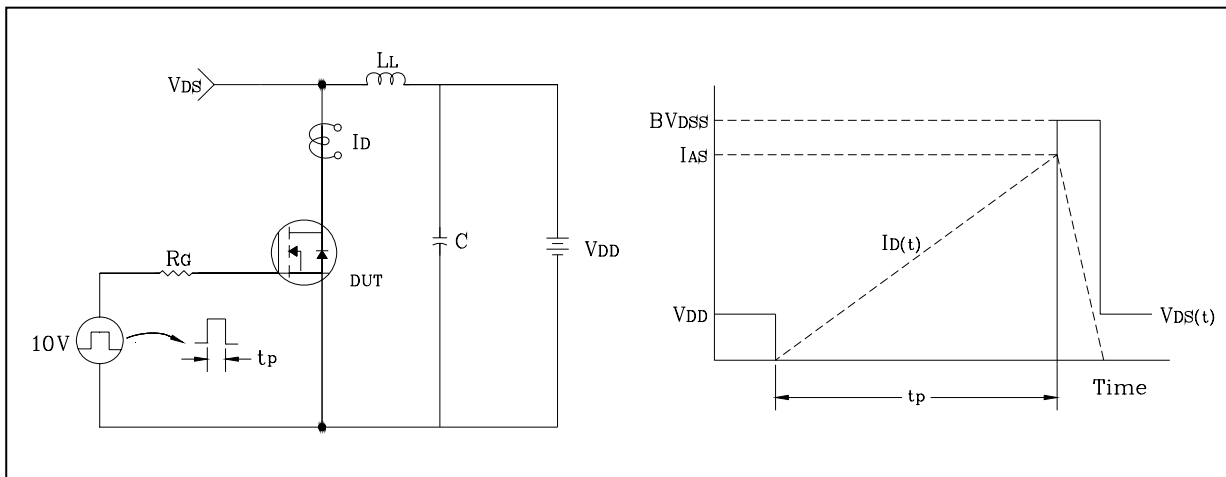
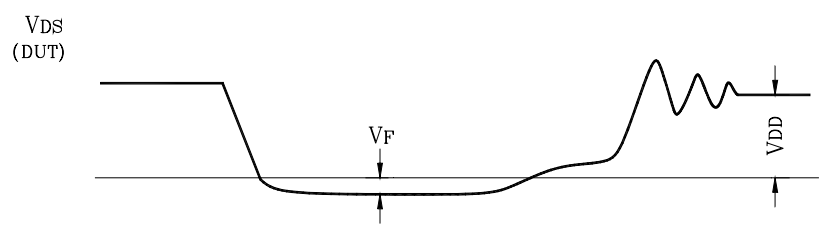
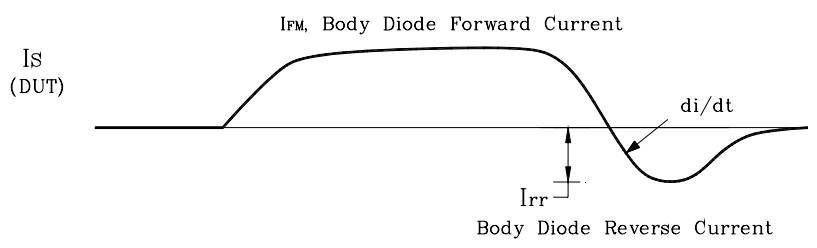
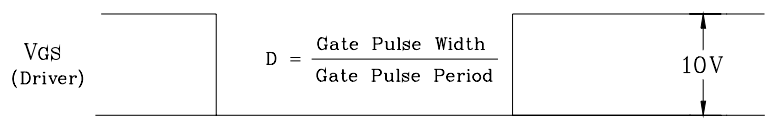
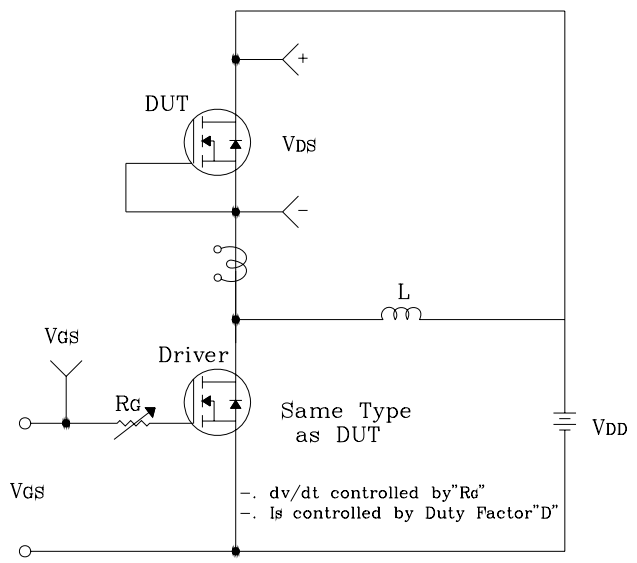

Fig. 14 Diode Reverse Recovery Time Test Circuit & Waveform



X-ON Electronics

Largest Supplier of Electrical and Electronic Components

Click to view similar products for [MOSFET](#) category:

Click to view products by [Truesemi](#) manufacturer:

Other Similar products are found below :

[IRFD120](#) [JANTX2N5237](#) [BUK455-60A/B](#) [MIC4420CM-TR](#) [VN1206L](#) [NDP4060](#) [SI4482DY](#) [IPS70R2K0CEAKMA1](#) [SQD23N06-31L-GE3](#)
[TK16J60W,S1VQ\(O](#) [2SK2614\(TE16L1,Q\)](#) [DMN1017UCP3-7](#) [DMN1053UCP4-7](#) [SQJ469EP-T1-GE3](#) [NTE2384](#) [DMC2700UDMQ-7](#)
[DMN2080UCB4-7](#) [DMN61D9UWQ-13](#) [US6M2GTR](#) [DMN31D5UDJ-7](#) [DMP22D4UFO-7B](#) [DMN1006UCA6-7](#) [DMN16M9UCA6-7](#)
[STF5N65M6](#) [IRF40H233XTMA1](#) [STU5N65M6](#) [DMN6022SSD-13](#) [DMN13M9UCA6-7](#) [DMTH10H4M6SPS-13](#) [DMN2990UFB-7B](#)
[IPB80P04P405ATMA2](#) [2N7002W-G](#) [MCAC30N06Y-TP](#) [MCQ7328-TP](#) [BXP7N65D](#) [BXP4N65F](#) [AOL1454G](#) [WMJ80N60C4](#) [BXP2N20L](#)
[BXP2N65D](#) [BXT1150N10J](#) [BXT1700P06M](#) [TSM60NB380CP](#) [ROG](#) [RQ7L055BGTCR](#) [DMNH15H110SK3-13](#) [SLF10N65ABV2](#)
[BSO203SP](#) [BSO211P](#) [IPA60R230P6](#) [IPA60R460CE](#)