



IR Receiver Modules for Remote Control Systems



23051

FEATURES

- Improved dark sensitivity
- Improved immunity against optical noise
- Very low supply current
- Photo detector and preamplifier in one package
- Internal filter for PCM frequency
- Supply voltage: 2.0 V to 3.6 V
- Insensitive to supply voltage ripple and noise
- Material categorization:
for definitions of compliance please see www.vishay.com/doc?99912



RoHS
COMPLIANT
HALOGEN
FREE
GREEN
(5-2008)

DESIGN SUPPORT TOOLS

[click logo to get started](#)



MECHANICAL DATA

1 = OUT, 2 = GND, 3 = V_S

DESCRIPTION

The TSOP93... series devices are the latest generation miniaturized IR receiver modules for infrared remote control systems. These series provide improvements in sensitivity to remote control signals in dark ambient as well as in sensitivity in the presence of optical disturbances e.g. from CFLs.

The devices contain a PIN diode and a preamplifier assembled on a lead frame. The epoxy package contains an IR filter. The demodulated output signal can be directly connected to a microprocessor for decoding.

The TSOP933.. and TSOP935.., series devices are designed to receive short burst codes (6 or more carrier cycles per burst). The third digit designates the AGC level (AGC3 or AGC5) and the last two digits designate the band-pass frequency (see table below). The higher the AGC, the better noise is suppressed, but the lower the code compatibility. AGC3 provides enhanced noise suppression and AGC5 provides maximized noise suppression. Generally, we advise to select the highest AGC that satisfactorily receives the desired remote code.

These components have not been qualified to automotive specifications.

PARTS TABLE			
AGC		ENHANCED NOISE SUPPRESSION (AGC3)	MAXIMIZED NOISE SUPPRESSION (AGC5)
Carrier frequency	30 kHz	TSOP93330	TSOP93530
	33 kHz	TSOP93333	TSOP93533
	36 kHz	TSOP93336 ⁽¹⁾⁽⁵⁾	TSOP93536
	38 kHz	TSOP93338 ⁽²⁾⁽⁴⁾	TSOP93538
	40 kHz	TSOP93340	TSOP93540
	56 kHz	TSOP93356	TSOP93556 ⁽³⁾
Package		Minimold	
Pinning		1 = OUT, 2 = GND, 3 = V _S	
Dimensions (mm)		5.4 W x 6.35 H x 4.9 D	
Mounting		Leaded	
Application		Remote control	
Best choice for		⁽¹⁾ RCMM ⁽²⁾ RECS-80 Code ⁽³⁾ r-map ⁽⁴⁾ XMP-1, XMP-2 ⁽⁵⁾ MCIR	

Note

- 30 kHz and 33 kHz only available on written request

BLOCK DIAGRAM

APPLICATION CIRCUIT

ABSOLUTE MAXIMUM RATINGS

PARAMETER	TEST CONDITION	SYMBOL	VALUE	UNIT
Supply voltage		V_S	-0.3 to +3.6	V
Supply current		I_S	3	mA
Output voltage		V_O	-0.3 to $(V_S + 0.3)$	V
Output current		I_O	5	mA
Junction temperature		T_j	100	°C
Storage temperature range		T_{stg}	-25 to +85	°C
Operating temperature range		T_{amb}	-25 to +85	°C
Power consumption	$T_{amb} \leq 85\text{ °C}$	P_{tot}	10	mW
Soldering temperature	$t \leq 10\text{ s}$, 1 mm from case	T_{sd}	260	°C

Note

- Stresses beyond those listed under “Absolute Maximum Ratings” may cause permanent damage to the device. This is a stress rating only and functional operation of the device at these or any other conditions beyond those indicated in the operational sections of this specification is not implied. Exposure to absolute maximum rating conditions for extended periods may affect the device reliability

ELECTRICAL AND OPTICAL CHARACTERISTICS ($T_{amb} = 25\text{ °C}$, unless otherwise specified)

PARAMETER	TEST CONDITION	SYMBOL	MIN.	TYP.	MAX.	UNIT
Supply current	$E_v = 0$, $V_S = 3.3\text{ V}$	I_{SD}	0.25	0.37	0.45	mA
	$E_v = 40\text{ klx}$, sunlight	I_{SH}	-	0.50	-	mA
Supply voltage		V_S	2.0	-	3.6	V
Transmission distance	$E_v = 0$, test signal see Fig. 1, IR diode TSAL6200, $I_F = 50\text{ mA}$	d	-	28	-	m
Output voltage low	$I_{OSL} = 0.5\text{ mA}$, $E_e = 0.7\text{ mW/m}^2$, test signal see Fig. 1	V_{OSL}	-	-	100	mV
Minimum irradiance	Test signal: XMP code	$E_e\text{ min.}$	-	0.12	0.25	mW/m ²
	Test signal: NEC code		-	0.09	0.20	
Maximum irradiance	$t_{pi} - 3.0/f_0 < t_{po} < t_{pi} + 3.5/f_0$, test signal see Fig. 1	$E_e\text{ max.}$	30	-	-	W/m ²
Directivity	Angle of half transmission distance	$\phi_{1/2}$	-	± 45	-	deg

TYPICAL CHARACTERISTICS ($T_{amb} = 25\text{ }^{\circ}\text{C}$, unless otherwise specified)



Fig. 1 - Output Delay and Pulse-Width



Fig. 4 - Pulse-Width vs. Irradiance in Dark Ambient



Fig. 2 - Pulse-Width vs. Irradiance in Dark Ambient



Fig. 5 - Frequency Dependence of Responsivity

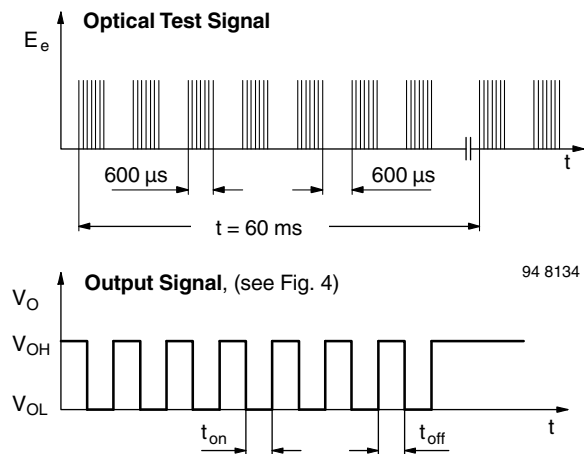

Fig. 3 - Test Signal

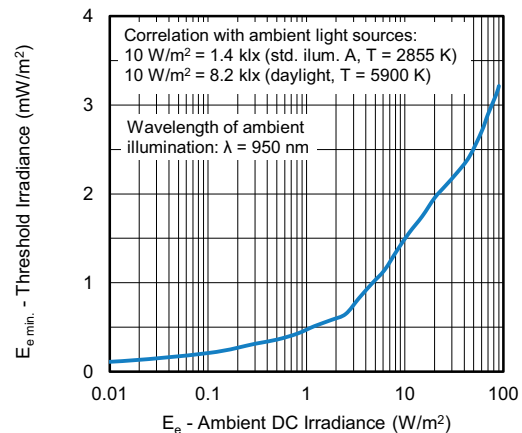

Fig. 6 - Sensitivity in Bright Ambient



Fig. 7 - Sensitivity vs. Supply Voltage Disturbances



Fig. 10 - Relative Spectral Sensitivity vs. Wavelength



Fig. 8 - Max. Envelope Duty Cycle vs. Burst Length

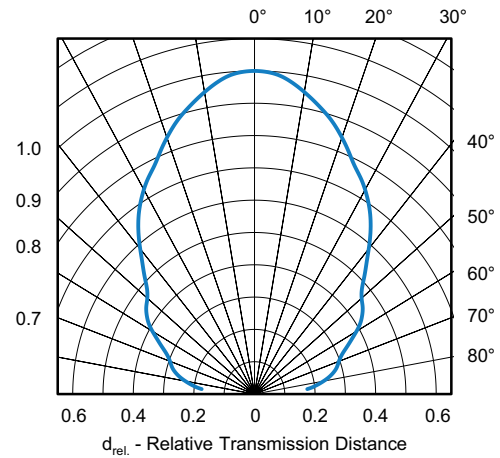

Fig. 11 - Directivity



Fig. 9 - Sensitivity vs. Ambient Temperature

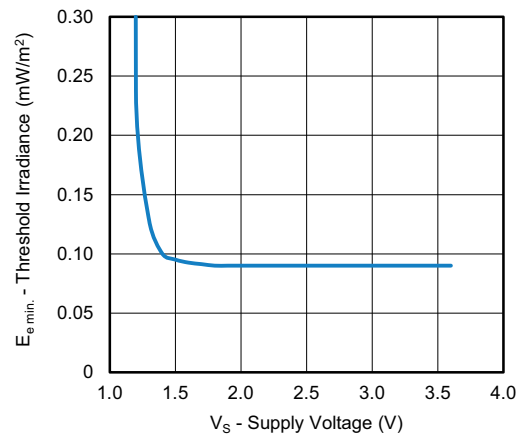

Fig. 12 - Sensitivity vs. Supply Voltage

SUITABLE DATA FORMAT

This series is designed to suppress spurious output pulses due to noise or disturbance signals. The devices can distinguish data signals from noise due to differences in frequency, burst length, and envelope duty cycle. The data signal should be close to the device's band-pass center frequency (e.g. 38 kHz) and fulfill the conditions in the table below.

When a data signal is applied to the product in the presence of a disturbance, the sensitivity of the receiver is automatically reduced by the AGC to insure that no spurious pulses are present at the receiver's output. Some examples which are suppressed are:

- DC light (e.g. from tungsten bulbs sunlight)
- Continuous signals at any frequency
- Strongly or weakly modulated patterns from fluorescent lamps with electronic ballasts (see Fig. 13 or Fig. 14)



Fig. 13 - IR Emission from Fluorescent Lamp With Low Modulation



Fig. 14 - IR Emission from Fluorescent Lamp With High Modulation

	TSOP933..	TSOP935..
Minimum burst length	6 cycles/burst	6 cycles/burst
After each burst of length A gap time is required of	6 to 20 cycles ≥ 8 cycles	6 to 38 cycles ≥ 8 cycles
For bursts greater than a minimum gap time in the data stream is needed of	20 cycles > 6 x burst length	38 cycles > 20 ms
Maximum number of continuous short bursts/second	2500	2500
RCMM code	Preferred	Yes
XMP-1 code	Preferred	Yes
r-map code	Yes	Preferred
RECS-80 code	Preferred	Yes
MCIR	Preferred	Yes
Suppression of interference from fluorescent lamps	Fig. 13 and Fig. 14	Fig. 13 and Fig. 14

Note

- For data formats with long bursts (more than 10 carrier cycles) please see the datasheet for TSOP932..., TSOP934..., or TSOP936..



PACKAGE DIMENSIONS in millimeters

Cav. no. Marking area

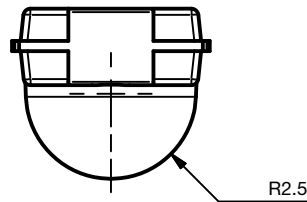
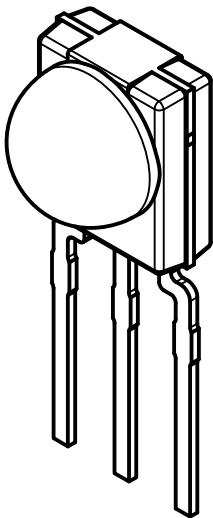
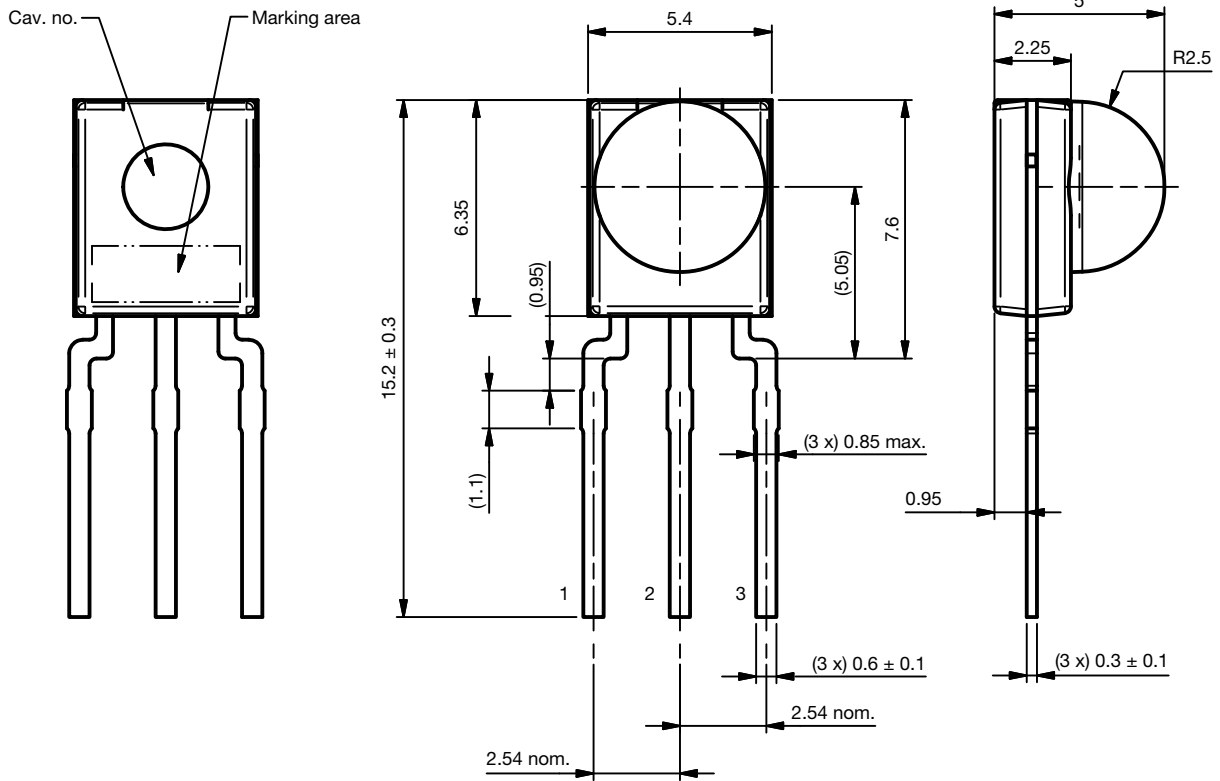

Not indicated tolerances ± 0.2

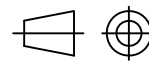

Technical drawings according to DIN specification.

Drawing no.: 6.550-5335.01-4
Issue: 1; 16.09.15



BULK PACKAGING

Standard shipping for minimold is in conductive plastic bags. The packing quantity is determined by weight and the number of components per carton may vary by a maximum of $\pm 0.3\%$.

ORDERING INFORMATION

Examples: TSOP93338
 TSOP93356V11
 TSOP93338SS1F

For more information, see: www.vishay.com/doc?80076

PACKAGING QUANTITY

- 300 pieces per bag (each bag is individually boxed)
- 6 bags per carton



Disclaimer

ALL PRODUCT, PRODUCT SPECIFICATIONS AND DATA ARE SUBJECT TO CHANGE WITHOUT NOTICE TO IMPROVE RELIABILITY, FUNCTION OR DESIGN OR OTHERWISE.

Vishay Intertechnology, Inc., its affiliates, agents, and employees, and all persons acting on its or their behalf (collectively, "Vishay"), disclaim any and all liability for any errors, inaccuracies or incompleteness contained in any datasheet or in any other disclosure relating to any product.

Vishay makes no warranty, representation or guarantee regarding the suitability of the products for any particular purpose or the continuing production of any product. To the maximum extent permitted by applicable law, Vishay disclaims (i) any and all liability arising out of the application or use of any product, (ii) any and all liability, including without limitation special, consequential or incidental damages, and (iii) any and all implied warranties, including warranties of fitness for particular purpose, non-infringement and merchantability.

Statements regarding the suitability of products for certain types of applications are based on Vishay's knowledge of typical requirements that are often placed on Vishay products in generic applications. Such statements are not binding statements about the suitability of products for a particular application. It is the customer's responsibility to validate that a particular product with the properties described in the product specification is suitable for use in a particular application. Parameters provided in datasheets and / or specifications may vary in different applications and performance may vary over time. All operating parameters, including typical parameters, must be validated for each customer application by the customer's technical experts. Product specifications do not expand or otherwise modify Vishay's terms and conditions of purchase, including but not limited to the warranty expressed therein.

Except as expressly indicated in writing, Vishay products are not designed for use in medical, life-saving, or life-sustaining applications or for any other application in which the failure of the Vishay product could result in personal injury or death. Customers using or selling Vishay products not expressly indicated for use in such applications do so at their own risk. Please contact authorized Vishay personnel to obtain written terms and conditions regarding products designed for such applications.

No license, express or implied, by estoppel or otherwise, to any intellectual property rights is granted by this document or by any conduct of Vishay. Product names and markings noted herein may be trademarks of their respective owners.

X-ON Electronics

Largest Supplier of Electrical and Electronic Components

Click to view similar products for [Infrared Receivers](#) category:

Click to view products by [Vishay](#) manufacturer:

Other Similar products are found below :

[TSOP38436](#) [TSOP38438CZ1](#) [TSOP6136TR](#) [IRM-3638N3](#) [TSOP2456](#) [TSOP31456](#) [TSOP34356](#) [TSOP34456](#) [TSOP38336](#) [TSOP6130TT](#)
[TSOP6940TT](#) [TSOP34438SS1V](#) [TSOP36438TT](#) [GP1UX511QS](#) [TSOP34336SS1F](#) [TSSP57038ETT1](#) [TSOP57438ETT1](#) [TSOP37438HTT1](#)
[TSOP6140TR](#) [TSOP53356](#) [TSOP53238](#) [TSOP33238](#) [TSOP33256](#) [TSOP53256](#) [TSOP33138](#) [TSOP6133TT](#) [R903V1-7C\(L\)](#) [ZPT034B-N](#) [ZPT034C](#)
[ZPT054B](#) [ZPT054C](#) [ZPTP28C](#) [ZPTP08C](#) [ZPD818B](#) [ZPD808B](#) [ZPD053B-90-S90](#) [ZPT-1608B-08-Z3](#) [HL-PST-1608PT1F](#) [HL-503PT1C-T](#) [HL-](#)
[304PT1C-T](#) [ZPD053B-60-S40](#) [ZIRM38NL-7](#) [LC191PTDT](#) [L-C153PTDT-Lens-HD](#) [DY-PT4133B-A2](#) [PT334-6B-52](#) [PT2424-6B](#)
[E6C0805PRAC1UDA](#) [TSOP31136](#) [TSOP31140](#)