

# Rotary Encoder

## Model EN11 Series



### Features:

- 11 mm
- 2 bits gray code
- Incremental/contacting type
- Metal bushing/shaft
- Push-on switch option



### Model Styles Available

Top Adjust, with Switch, Threaded Bushing	EN11-HSM
Top Adjust, without Switch, Threaded Bushing	EN11-HNM
Top Adjust, with Switch, Plain Bushing	EN11-HSB
Top Adjust, without Switch, Plain Bushing	EN11-HNB
Side Adjust, with Switch, Threaded Bushing	EN11-VSM
Side Adjust, without Switch, Threaded Bushing	EN11-VNM
Side Adjust, with Switch, Plain Bushing	EN11-VSB
Side Adjust, without Switch, Plain Bushing	EN11-VNB

### Electrical

Pulses ( Per Revolution )	15, 20
Encoder Closed Circuit Resistance	3 Ohms, max.
Encoder Contact Rating	10mA/ 5Vdc
Operating Current, Maximum	10mA
Dielectric Strength	300Vac/1mA, 1 minute
Insulation Resistance, Minimum	100M ohms at 250Vdc/ 1mA
Sliding Noise ( at 60 RPM )	2.0ms max.
Contact Bounce ( at 15 RPM)	5.0ms max.
Operating Speed ( RPM )	100 RPM max.
Switch Power rating	10mA/ 5Vdc
Switch Contact Resistance	100 milliohms
Actual Electrical Travel, Nominal	Continuous

### Mechanical

Total Mechanical Travel	Continuous
Detents ( per Revolution)	0, 20 and 30
Rotational Torque of Detent, Maximum	2.5 oz-in
Switch Operating Force	550 gf
Switch Travel	0.5mm

#### General Note

TT Electronics reserves the right to make changes in product specification without notice or liability. All information is subject to TT Electronics' own data and is considered accurate at time of going to print.

### Environmental

Rotational Life

30,000 cycles

### Ordering

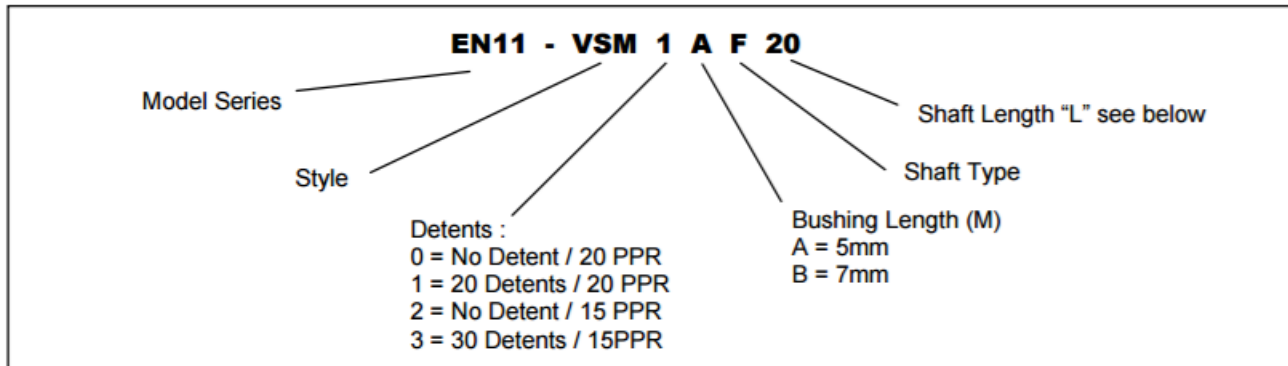

### Shaft Types

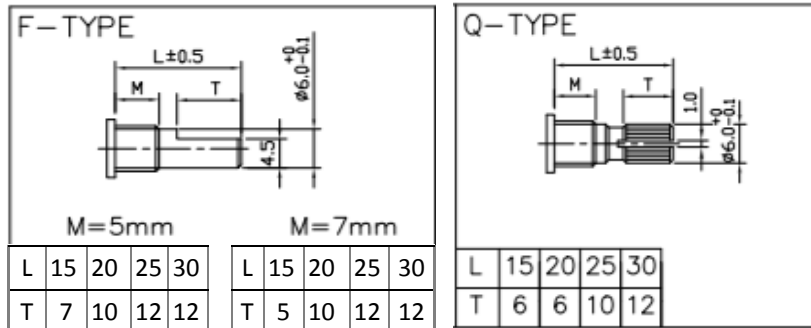

### Circuit Diagram

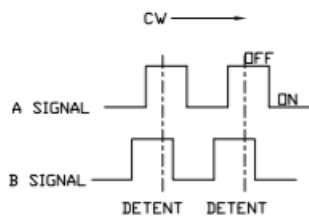

**For 20 PPR (B leads A)**

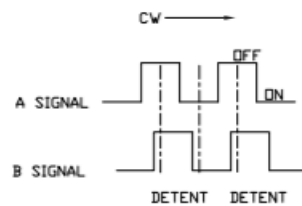

**For 15 PPR (A leads B)**



### Outline Drawings

**MODEL EN11-HSM**  
(Top Adjust, with Switch, Threaded Bushing)

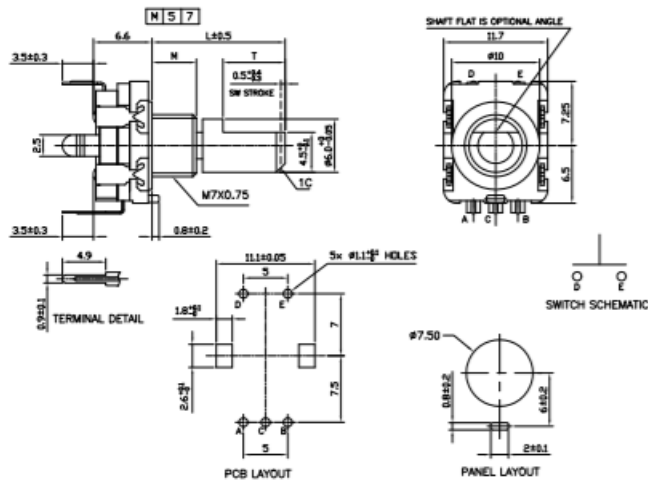

**MODEL EN11-HNM**  
(Top Adjust, without Switch, Threaded Bushing)

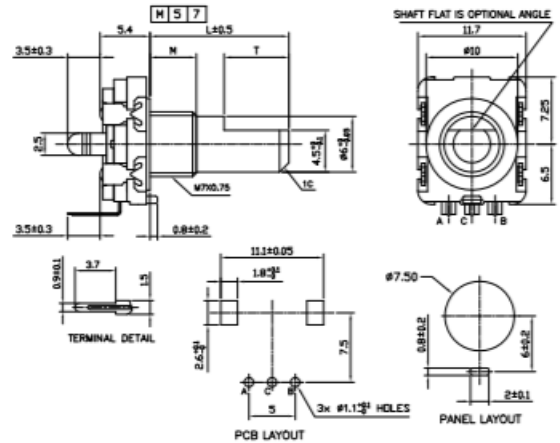

**MODEL EN11-HSB**  
(Top Adjust, with Switch, Plain Bushing)

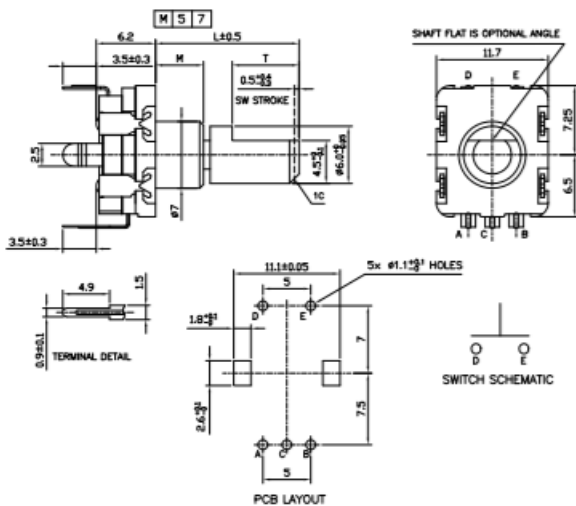

**MODEL EN11-HNB**  
(Top Adjust, without Switch, Plain Bushing)

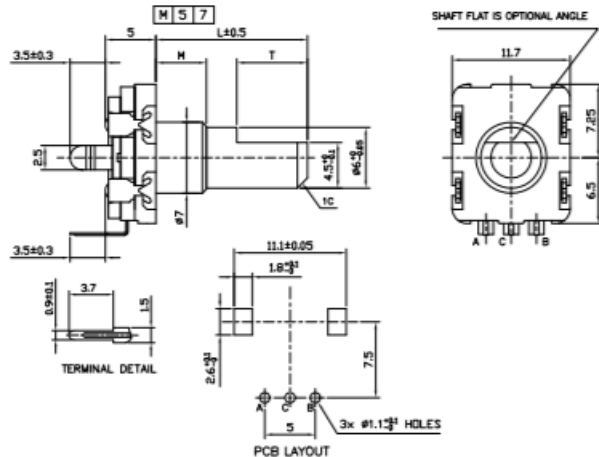

## X-ON Electronics

Largest Supplier of Electrical and Electronic Components

*Click to view similar products for [Encoders](#) category:*

*Click to view products by [TT Electronics](#) manufacturer:*

Other Similar products are found below :

[6-1393048-0](#) [6-1393048-5](#) [62AG22-H5-P](#) [700-09-36](#) [1393047-3](#) [ECW1J-C36-SE0/077L](#) [2-1393047-2](#) [25LB22-G-Z](#) [T101-5C3-111-M1](#)  
[385001M0439](#) [385001M0216](#) [V23401H1409B101](#) [V23401T8002B802](#) [V23401U6019B609](#) [62B11-LPP-040C](#) [62HS22-H0-040S](#) [700-16-16](#)  
[700-24-24](#) [V23401D1001B102](#) [3-1393048-1](#) [288T220R161A2](#) [1-1879391-5](#) [GH65C11-N-SO](#) [1393047-1](#) [702-01-24](#) [703-20-00](#) [62V22-02-P](#)  
[62D15-02-140S](#) [61K128-075](#) [EC21C1520402](#) [62AG18-L5-020C](#) [E6F-AG5C 720 2M](#) [62B22-SPP-030C](#) [60016-005](#) [31215-003](#) [01039-2677](#)  
[ACZ11BR2E-20FD1-20CZ-0546](#) [DXM510-2000S002](#) [01002-2133](#) [01002-9375](#) [01002-9572](#) [01026-476](#) [01039-1102](#) [01039-1981](#) [01070-](#)  
[1315](#) [01072-513](#) [01080-056](#) [01084-089](#) [01094-017](#) [01102-031](#)