

# Power Inductors

## Model HA72L-0420 series

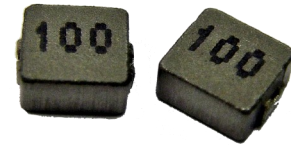

### Features:

- Operating Temperature Range  $-55^{\circ}\text{C}$  to  $+155^{\circ}\text{C}$
- Ambient Temperature, Maximum  $+115^{\circ}\text{C}$
- Temperature Rise,  $40^{\circ}\text{C}$
- RoHS Compliant
- AEC-Q200 Certified

### Schematic

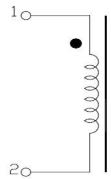

### Specifications @ $25^{\circ}\text{C}$

Part Number	Inductance ( $\mu\text{H} \pm 20\%$ @0A)	DCR ( $\text{m}\Omega$ ) Typ	DCR ( $\text{m}\Omega$ ) Max	I <sub>rms</sub> (A)	I <sub>sat</sub> (A)	Part Number	Inductance ( $\mu\text{H} \pm 20\%$ @0A)	DCR ( $\text{m}\Omega$ ) Typ.	DCR ( $\text{m}\Omega$ ) Max	I <sub>rms</sub> (A)	I <sub>sat</sub> (A)
HA72L-0420R10LFTR	0.10	3.5	4.0	12.0	22.0	HA72L-04201R5LFTR	1.50	38.0	46.0	4.0	6.0
HA72L-0420R22LFTR	0.22	6.0	6.6	9.0	12.5	HA72L-04202R2LFTR	2.20	52.0	58.0	3.0	5.0
HA72L-0420R33LFTR	0.33	9.6	13.0	8.0	12.0	HA72L-04203R3LFTR	3.30	74.0	87.0	2.5	4.0
HA72L-0420R47LFTR	0.47	12.5	14.0	7.0	9.5	HA72L-04204R7LFTR	4.70	98.0	110.0	2.0	3.5
HA72L-0420R56LFTR	0.56	14.0	16.0	6.5	10.0	HA72L-04205R6LFTR	5.60	105.0	115.0	1.8	3.0
HA72L-0420R68LFTR	0.68	16.0	18.0	6.0	9.0	HA72L-04206R8LFTR	6.80	160.0	175.0	1.5	2.5
HA72L-04201R0LFTR	1.00	24.0	27.0	4.5	7.0	HA72L-0420100LFTR	10.0	256.0	282.0	1.2	2.2
HA72L-04201R2LFTR	1.20	24.0	27.0	4.5	7.0						

- Notes:
- (1) I<sub>sat</sub> is the saturation current at which inductance rolls off approximately 30% from its initial (zero DC)
  - (2) I<sub>rms</sub> is the approximate current at which  $\Delta T = 40^{\circ}\text{C}$
  - (3) Operating Temperature Range  $-55^{\circ}\text{C}$  to  $+155^{\circ}\text{C}$
  - (4) Test condition for all case sizes is 100kHz @ 1V

#### General Note

TT Electronics reserves the right to make changes in product specification without notice or liability. All information is subject to TT Electronics' own data and is considered accurate at time of going to print.

### Electrical Specifications @ 25°C

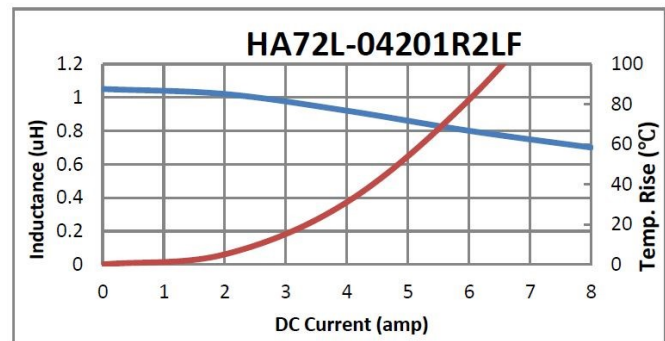
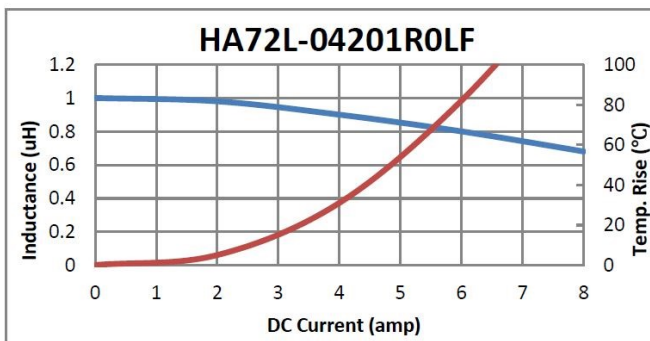
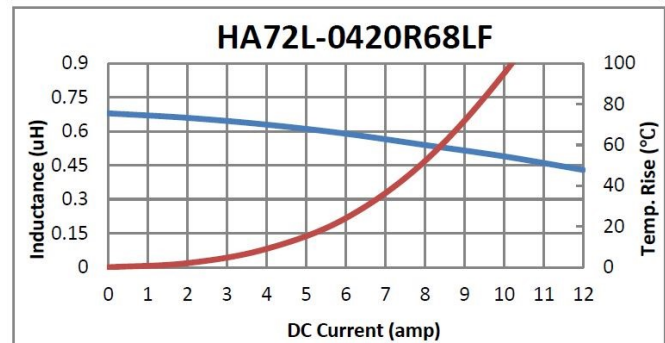
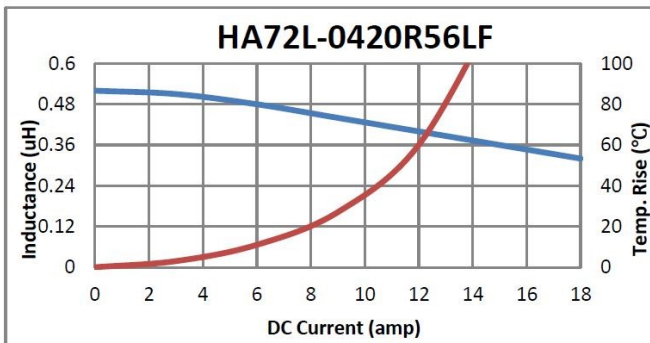
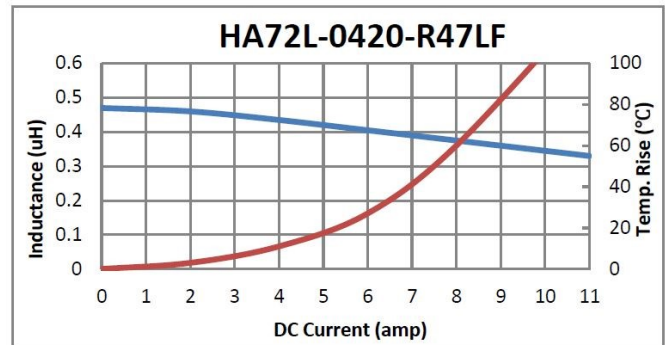
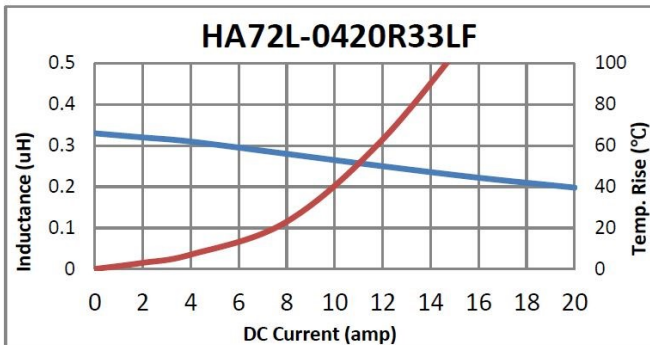
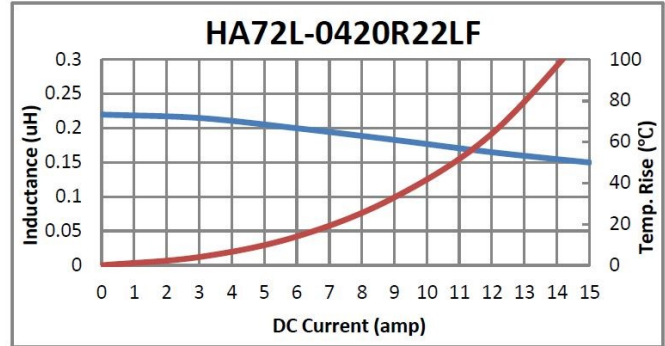
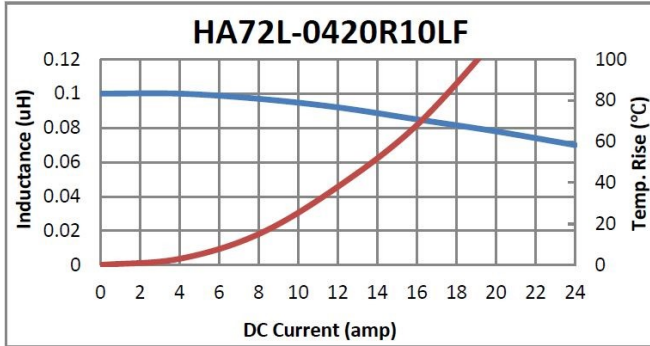

General Note  
 TT Electronics reserves the right to make changes in product specification without notice or liability. All information is subject to TT Electronics' own data and is considered accurate at time of going to print.

### Electrical Characteristics @ 25°C

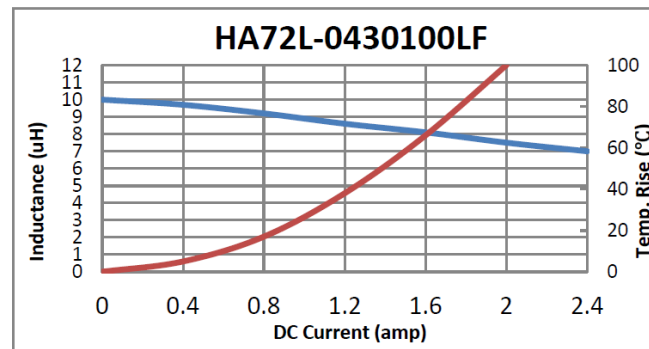
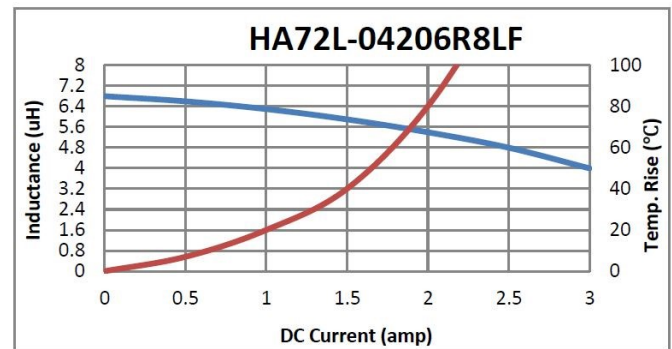
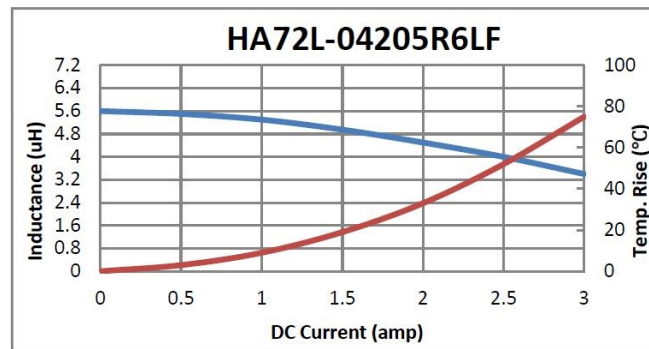
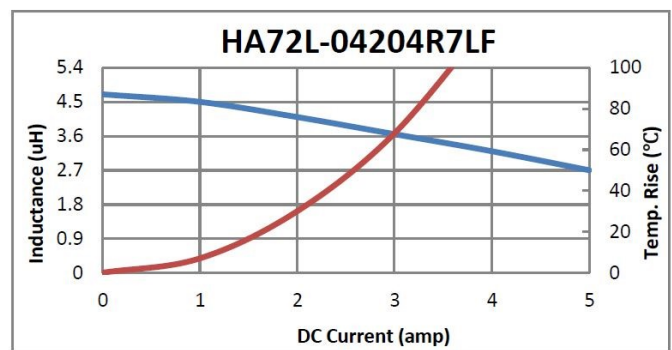
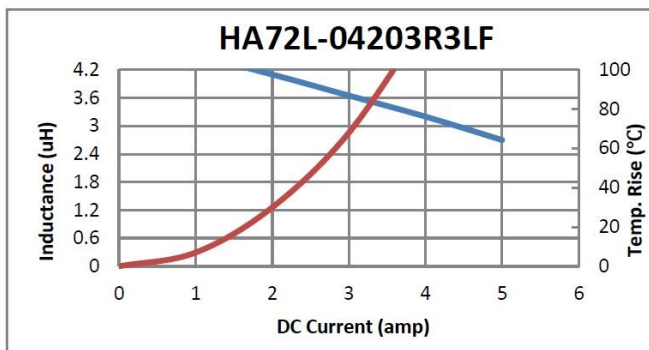
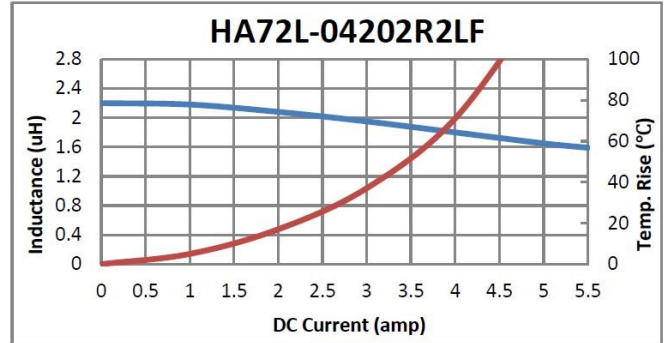
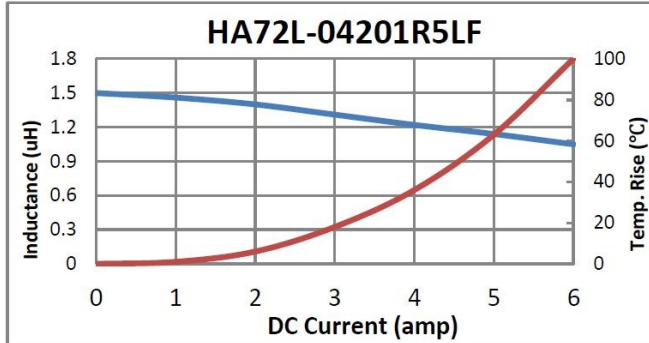

General Note  
 TT Electronics reserves the right to make changes in product specification without notice or liability. All information is subject to TT Electronics' own data and is considered accurate at time of going to print.

TT Electronics | BI Technologies  
 A-1445, Jalan Tanjung Api  
 25050 Kuantan Pahang Darul Makmur, Malaysia | Ph: +60 9 565 8888  
[www.ttelectronicsmagnetics.com/customer-service-enquiry](http://www.ttelectronicsmagnetics.com/customer-service-enquiry)

### Outline dimensions (mm)

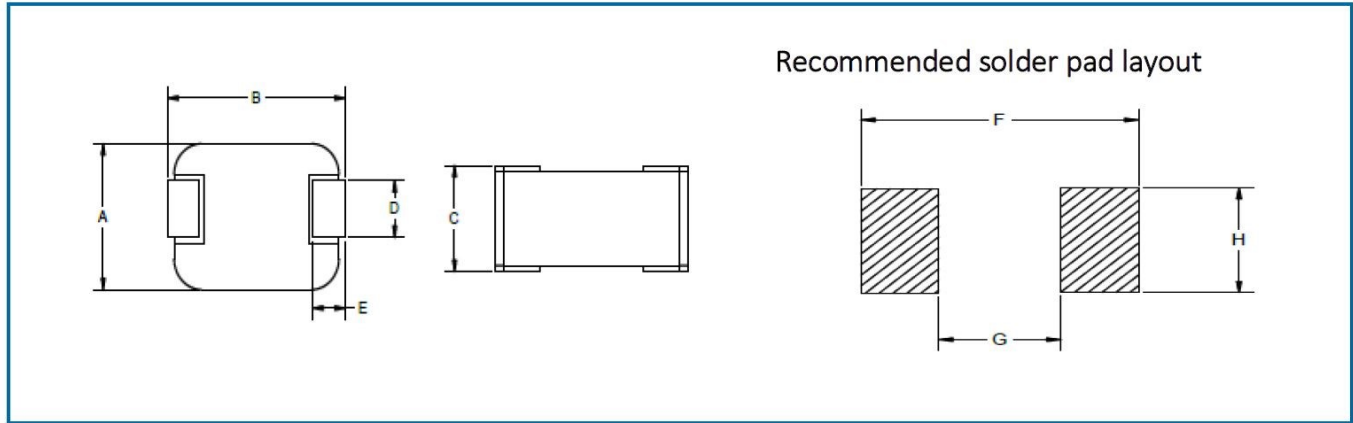

CASE SIZE	A(mm)	B(mm)	C(mm)	D(mm)	E(mm)	F(mm)	G(mm)	H(mm)
0420 series	4.05 ± 0.25	4.45 ± 0.25	2	1.5 ± 0.3	0.8 ± 0.3	4.95	2.15	2.30

### Packaging

Standard:	Embossed Tape and Reel			
	Reel:	Diameter	All case size	= 13" (330mm)
		Capacity	Case size 0420	= 2,000 units

### Ordering information

HA72L – XXXX XXX LF TR XX

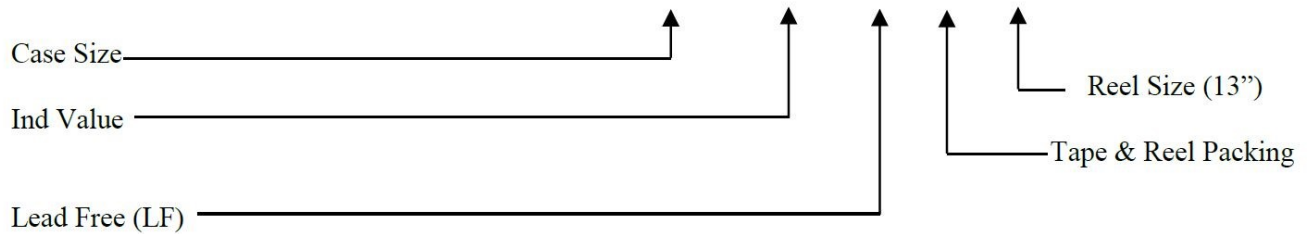

## X-ON Electronics

Largest Supplier of Electrical and Electronic Components

*Click to view similar products for [TT ELECTRONICS](#) manufacturer:*

Other Similar products are found below :

[L061S391LF](#) [L091S224LF](#) [L061S220LF](#) [BCN164A562J7](#) [62PR25KLF](#) [56BW-FIFTY-PKG](#) [CHP1501R00FLF](#) [BCN164AB470J7](#) [898-3-R150K](#) [66XR10](#) [66XR200K](#) [66XR2K](#) [66XR50](#) [67WR1MEG](#) [67WR200KLFTB](#) [67ZR200](#) [68WR5K](#) [68XR2MEG](#) [72PXR10K](#) [72XR2.5K](#) [8109](#) [82PR25K](#) [84WR10KTR](#) [OPB660N](#) [OPB748WZ](#) [OPB870T55](#) [OPI1266](#) [P110KV1-0Y20BR50K](#) [JANTX4N24A](#) [89XHR10K](#) [L083C101](#) [91XR5K](#) [SML100M12MSF](#) [PFC-W0805LF-03-2870-B](#) [2627](#) [CR200L.5](#) [RC07GF220J](#) [RC20GF272J](#) [RC55LF-D-196R-B-B](#) [HM00-01800](#) [HM71-10220LFTR](#) [3371R5KL.25](#) [L083C122](#) [W23-330RJI](#) [WH25-47RJI](#) [040585XM](#) [6679-420-0](#) [OP231](#) [OPB471T11](#) [OPB817Z](#)