

Power Inductors

Model HA72L-1265 series



Features:

- Operating Temperature Range -55°C to $+155^{\circ}\text{C}$
- Ambient Temperature, Maximum $+115^{\circ}\text{C}$
- Temperature Rise, 40°C
- RoHS Compliant
- AEC-Q200 Certified

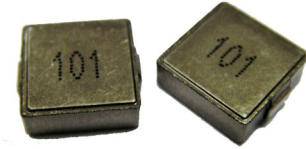

Schematic

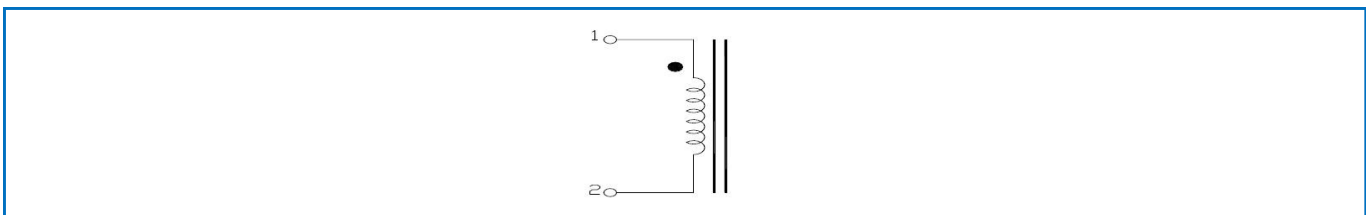

Specifications @ 25°C

| Part Number | Inductance ($\mu\text{H} \pm 20\%$ @0A) | DCR ($\text{m}\Omega$) Typ | DCR ($\text{m}\Omega$) Max | I _{rms} (A) | Isat (A) | Part Number | Inductance ($\mu\text{H} \pm 20\%$ @0A) | DCR ($\text{m}\Omega$) Typ. | DCR ($\text{m}\Omega$) Max | I _{rms} (A) | Isat (A) |
|-------------------|--|------------------------------|------------------------------|----------------------|----------|-------------------|--|-------------------------------|------------------------------|----------------------|----------|
| HA72L-1265R10LFTR | 0.10 | 0.47 | 0.50 | 60.0 | 80.0 | HA72L-12652R8LFTR | 2.80 | 4.20 | 4.80 | 20.0 | 25.0 |
| HA72L-1265R15LFTR | 0.15 | 0.53 | 0.60 | 55.0 | 80.0 | HA72L-12653R3LFTR | 3.30 | 5.70 | 6.80 | 18.0 | 35.0 |
| HA72L-1265R22LFTR | 0.22 | 0.63 | 0.70 | 53.0 | 80.0 | HA72L-12654R2LFTR | 4.20 | 5.80 | 7.20 | 11.0 | 28.0 |
| HA72L-1265R30LFTR | 0.30 | 0.70 | 0.80 | 48.0 | 72.0 | HA72L-12654R7LFTR | 4.70 | 9.30 | 11.20 | 13.5 | 30.0 |
| HA72L-1265R33LFTR | 0.33 | 0.83 | 0.90 | 46.0 | 65.0 | HA72L-12655R6LFTR | 5.60 | 11.80 | 12.80 | 12.0 | 26.5 |
| HA72L-1265R40LFTR | 0.40 | 0.90 | 1.00 | 44.0 | 64.0 | HA72L-12656R8LFTR | 6.80 | 13.10 | 14.00 | 11.5 | 16.5 |
| HA72L-1265R47LFTR | 0.47 | 1.00 | 1.20 | 41.0 | 63.0 | HA72L-12658R2LFTR | 8.20 | 14.50 | 15.50 | 10.5 | 16.0 |
| HA72L-1265R56LFTR | 0.56 | 1.20 | 1.40 | 37.0 | 62.0 | HA72L-1265100LFTR | 10.0 | 15.80 | 16.80 | 10.0 | 15.5 |
| HA72L-1265R68LFTR | 0.68 | 1.40 | 1.60 | 35.0 | 60.0 | HA72L-1265120LFTR | 12.0 | 23.00 | 26.00 | 9.0 | 14.0 |
| HA72L-1265R82LFTR | 0.82 | 1.60 | 1.90 | 33.0 | 50.0 | HA72L-1265150LFTR | 15.0 | 25.00 | 29.00 | 6.0 | 9.0 |
| HA72L-12651R0LFTR | 1.00 | 1.70 | 2.00 | 32.0 | 49.0 | HA72L-1265220LFTR | 22.0 | 34.00 | 39.50 | 5.0 | 7.5 |
| HA72L-12651R2LFTR | 1.20 | 2.10 | 2.50 | 30.0 | 48.0 | HA72L-1265330LFTR | 33.0 | 55.00 | 65.00 | 4.0 | 6.0 |
| HA72L-12651R5LFTR | 1.50 | 2.50 | 3.00 | 27.0 | 45.0 | HA72L-1265470LFTR | 47.0 | 80.00 | 92.00 | 3.0 | 5.0 |
| HA72L-12651R8LFTR | 1.80 | 2.80 | 3.20 | 24.0 | 41.0 | HA72L-1265680LFTR | 68.0 | 122.0 | 134.0 | 2.0 | 3.5 |
| HA72L-12652R2LFTR | 2.20 | 3.50 | 4.20 | 22.0 | 40.0 | | | | | | |

- Notes:
- (1) Isat is the saturation current at which inductance rolls off approximately 30% from its initial (zero DC)
 - (2) I_{rms} is the approximate current at which $\Delta T = 40^{\circ}\text{C}$
 - (3) Operating Temperature Range -55°C to $+155^{\circ}\text{C}$
 - (4) Test conditions for all case sizes is 100kHz @ 1V

General Note

TT Electronics reserves the right to make changes in product specification without notice or liability. All information is subject to TT Electronics' own data and is considered accurate at time of going to print.

TT Electronics | BI Technologies
A-1445, Jalan Tanjung Api

25050 Kuantan Pahang Darul Makmur, Malaysia | Ph: +60 9 565 8888
www.ttelectronicsmagnetics.com/customer-service-enquiry

Electrical Specifications

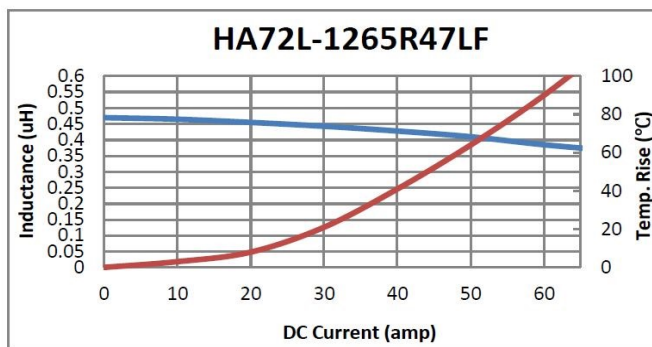
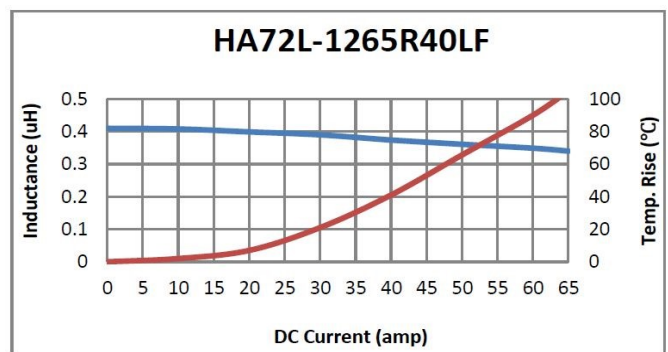
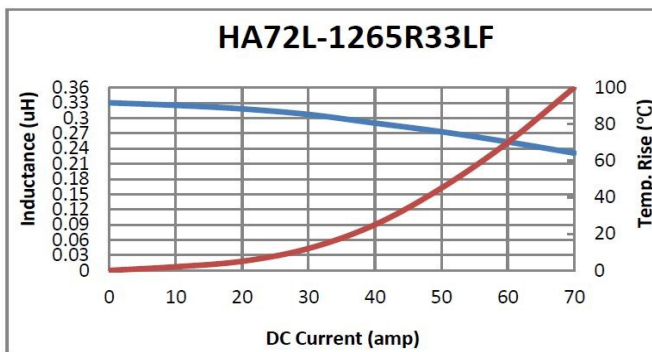
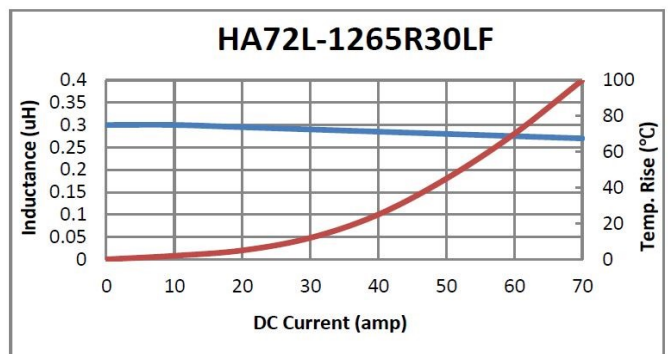
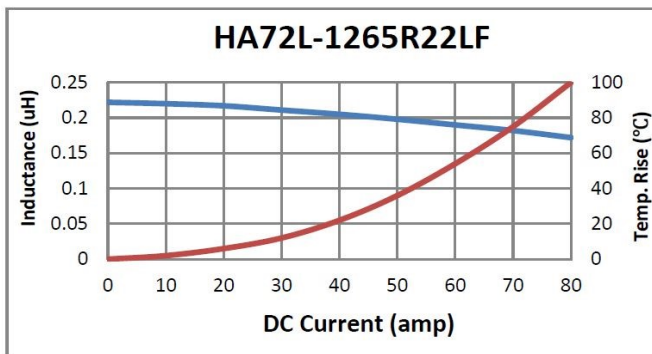
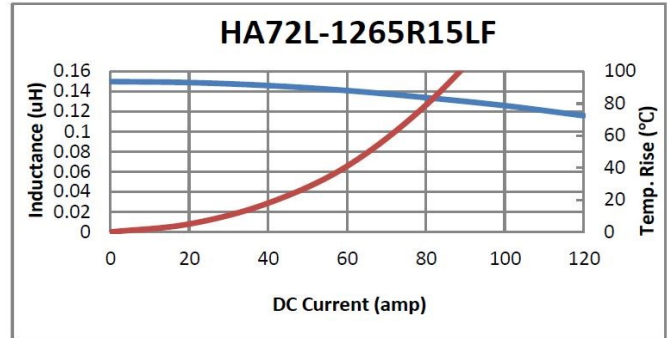
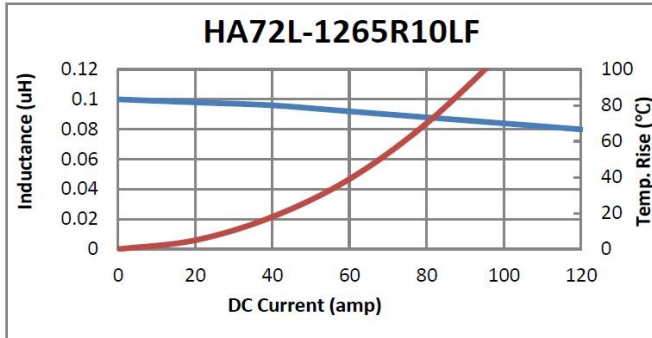

General Note
 TT Electronics reserves the right to make changes in product specification without notice or liability. All information is subject to TT Electronics' own data and is considered accurate at time of going to print.

TT Electronics | BI Technologies
 A-1445, Jalan Tanjung Api
 25050 Kuantan Pahang Darul Makmur, Malaysia | Ph: +60 9 565 8888
www.ttelectronicsmagnetics.com/customer-service-enquiry

Electrical Characteristics

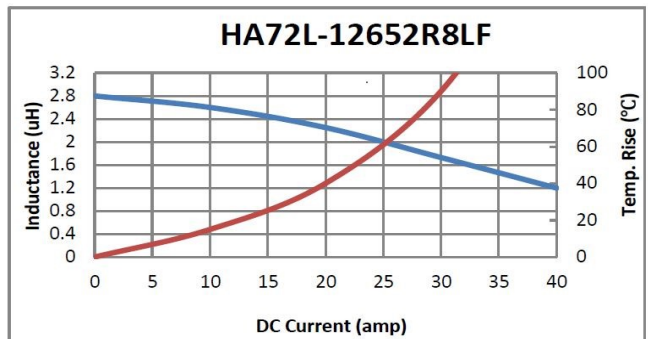
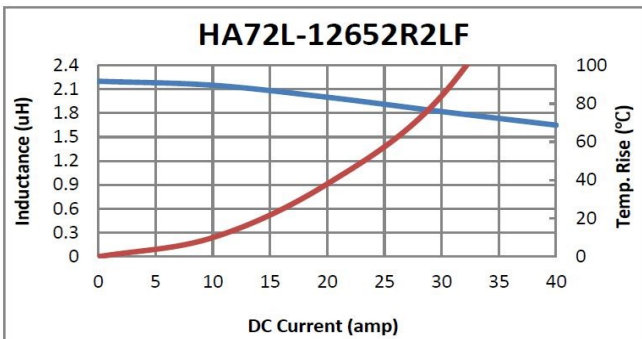
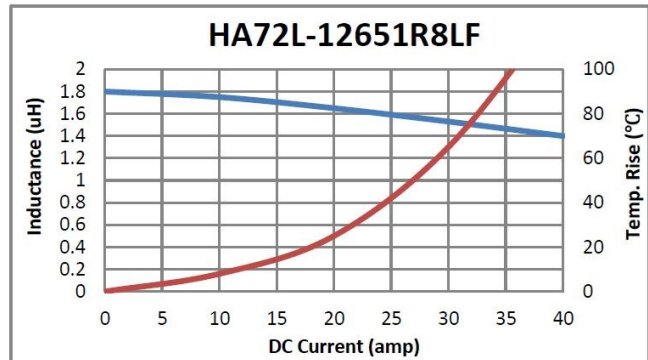
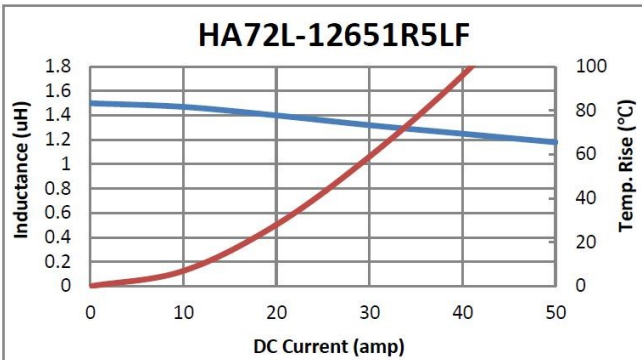
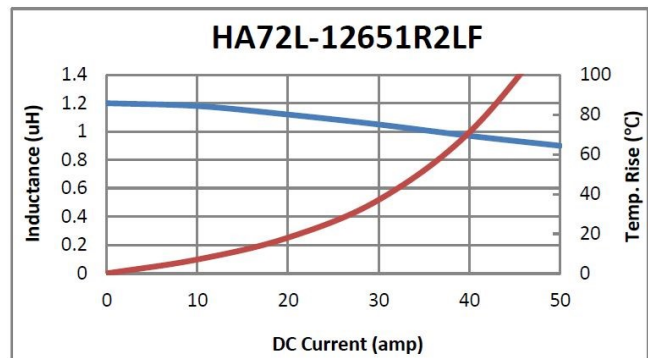
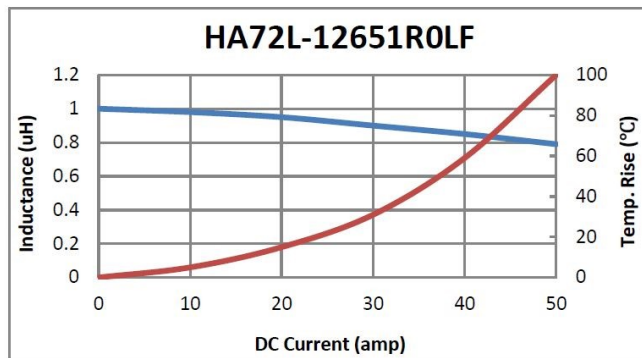
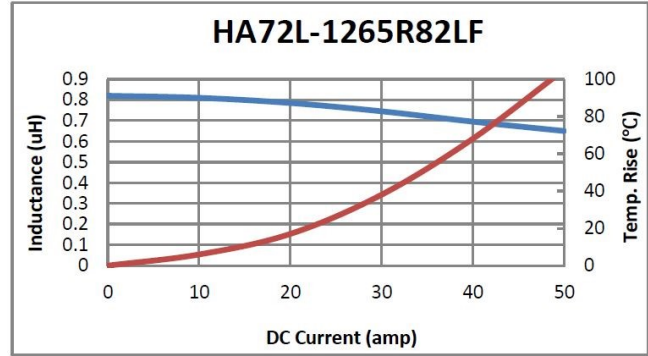
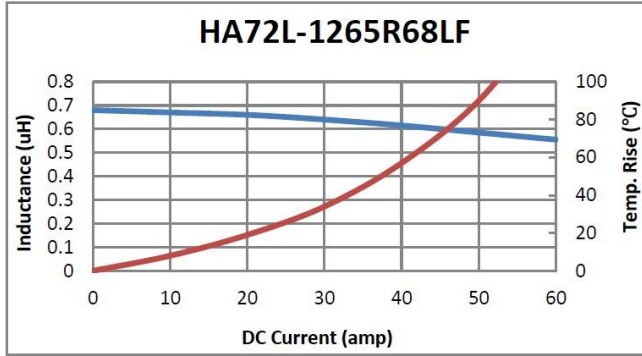

General Note
 TT Electronics reserves the right to make changes in product specification without notice or liability. All information is subject to TT Electronics' own data and is considered accurate at time of going to print.

TT Electronics | BI Technologies
 A-1445, Jalan Tanjung Api
 25050 Kuantan Pahang Darul Makmur, Malaysia | Ph: +60 9 565 8888
www.ttelectronicsmagnetics.com/customer-service-enquiry

Electrical Characteristics

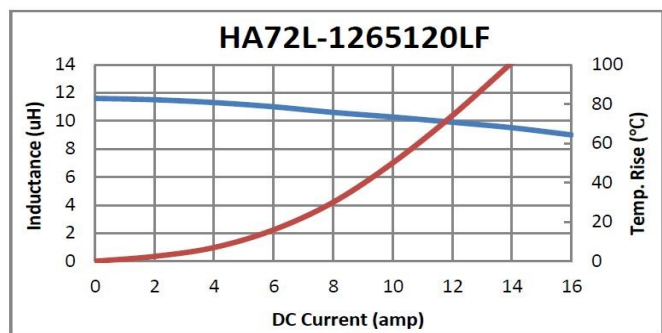
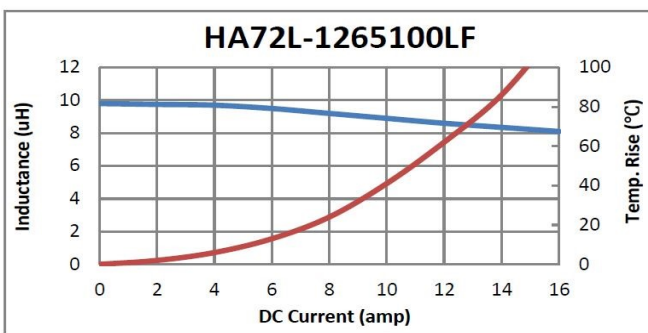
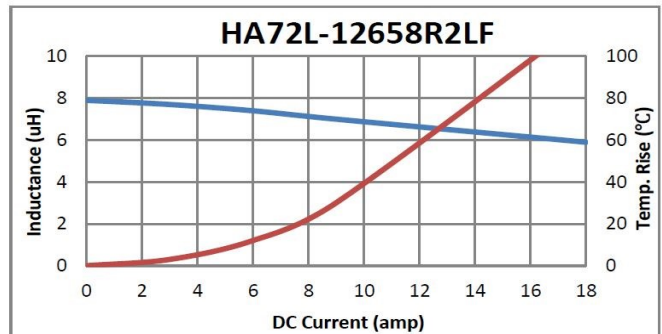
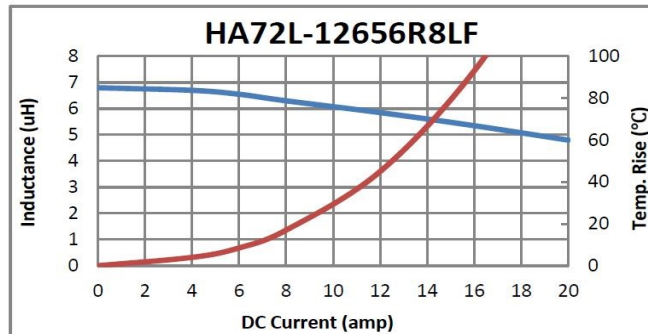
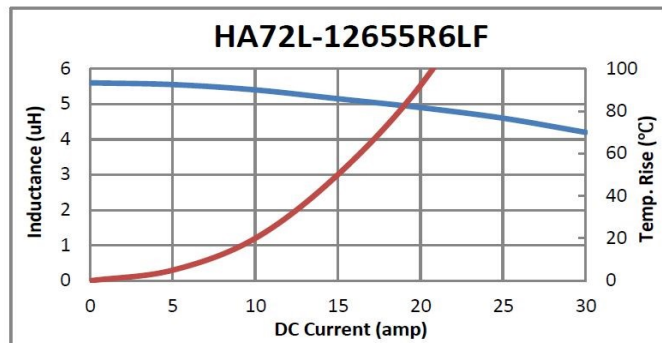
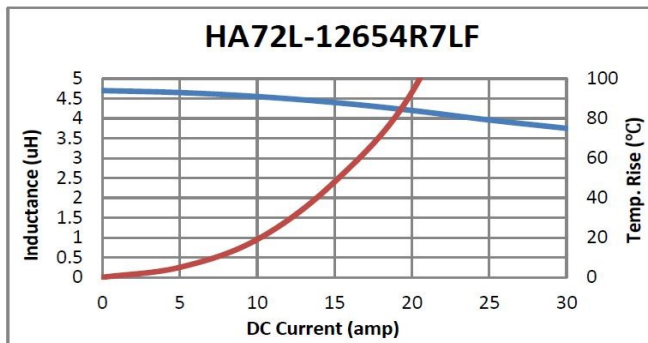
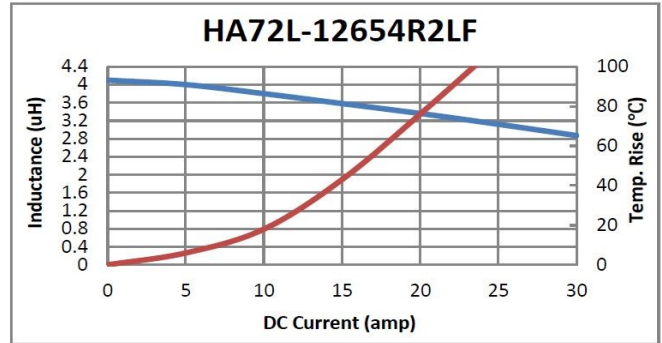
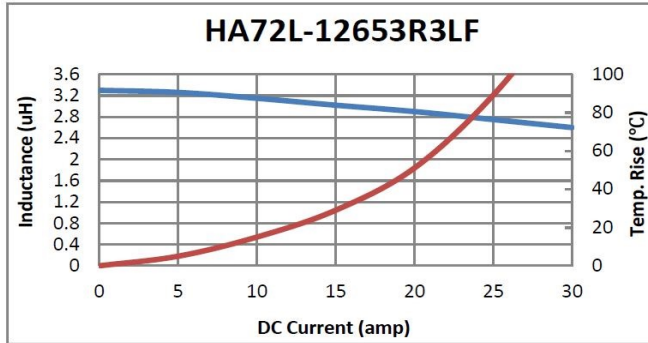

General Note
 TT Electronics reserves the right to make changes in product specification without notice or liability. All information is subject to TT Electronics' own data and is considered accurate at time of going to print.

TT Electronics | BI Technologies
 A-1445, Jalan Tanjung Api
 25050 Kuantan Pahang Darul Makmur, Malaysia | Ph: +60 9 565 8888
www.ttelectronicsmagnetics.com/customer-service-enquiry

Power Inductors

Model HA72L-1265 series

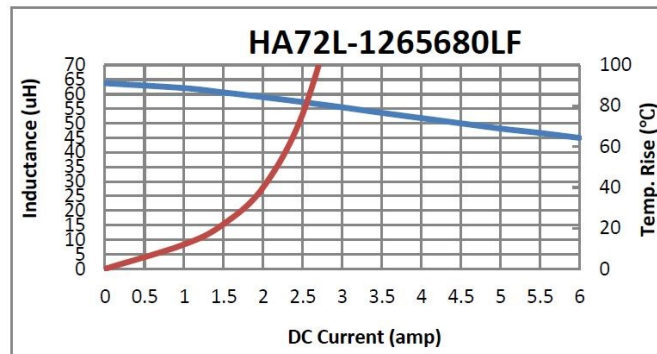
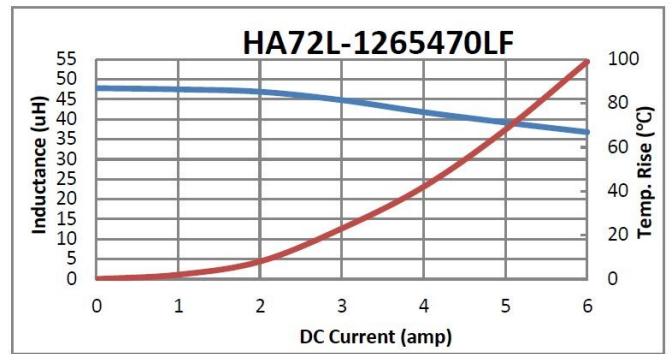
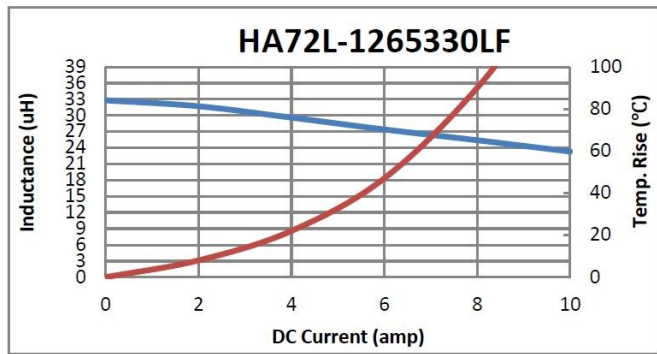
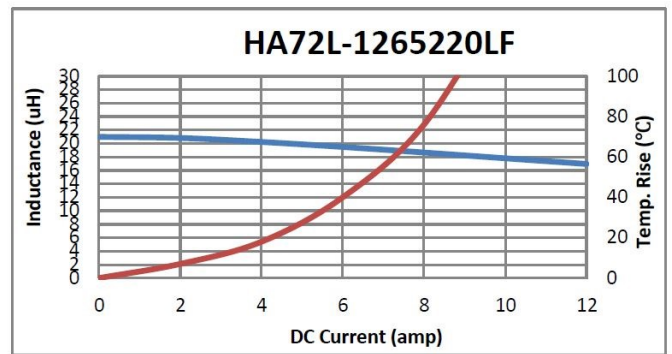
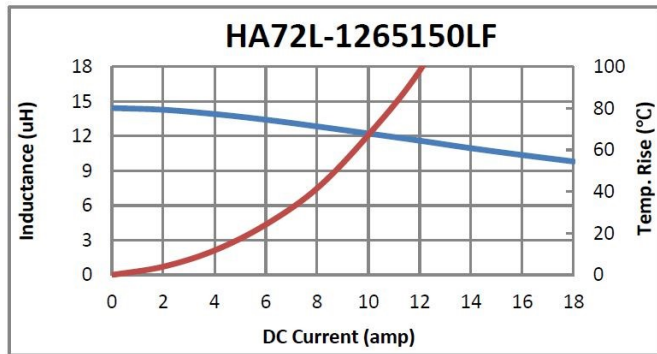

General Note
 TT Electronics reserves the right to make changes in product specification without notice or liability. All information is subject to TT Electronics' own data and is considered accurate at time of going to print.

TT Electronics | BI Technologies
 A-1445, Jalan Tanjung Api
 25050 Kuantan Pahang Darul Makmur, Malaysia | Ph: +60 9 565 8888
www.ttelectronicsmagnetics.com/customer-service-enquiry

Outline dimensions (mm)

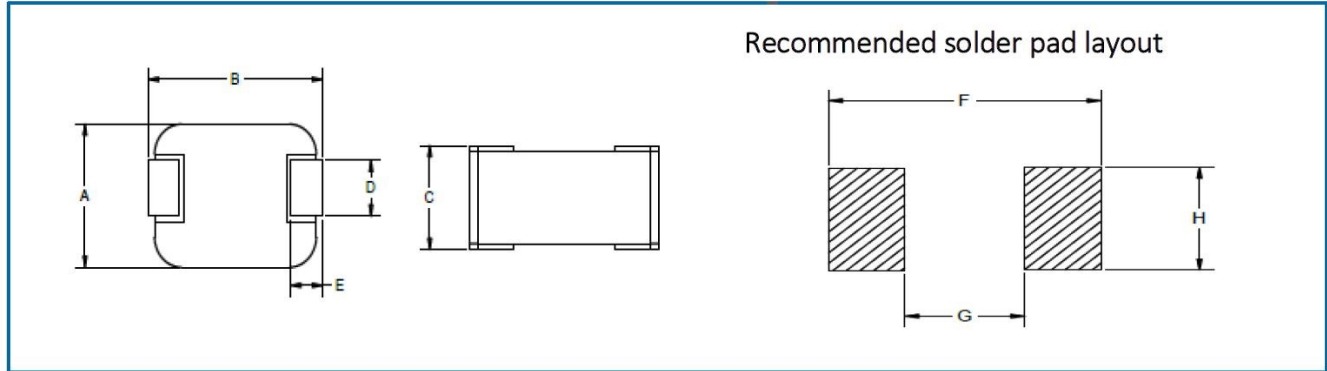

| CASE SIZE | A(mm) | B(mm) | C(mm) | D(mm) | E(mm) | F(mm) | G(mm) | H(mm) |
|-------------|------------|------------|-------|-----------|-----------|-------|-------|-------|
| 1265 series | 12.8 ± 0.3 | 13.5 ± 0.5 | 6.5 | 3.5 ± 0.5 | 2.5 ± 0.5 | 15 | 6 | 5 |

Packaging

| | | | | |
|-----------|------------------------|----------|----------------|---------------|
| Standard: | Embossed Tape and Reel | | | |
| | Reel: | Diameter | All case size | = 13" (330mm) |
| | | Capacity | Case size 1265 | = 400 units |

Ordering information

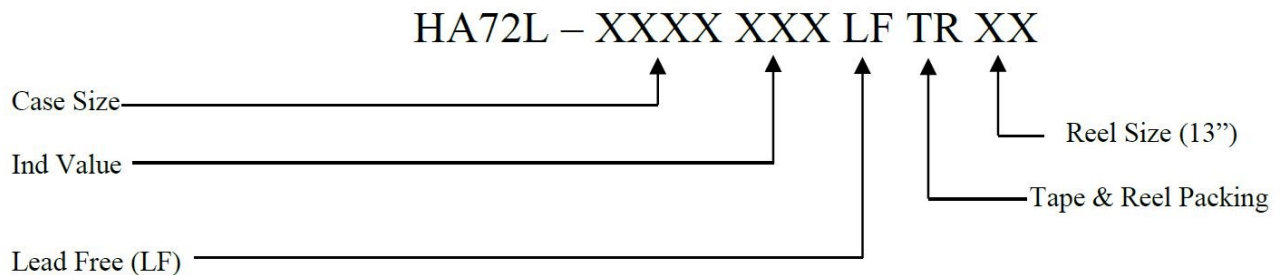

X-ON Electronics

Largest Supplier of Electrical and Electronic Components

Click to view similar products for [TT ELECTRONICS](#) manufacturer:

Other Similar products are found below :

[L061S391LF](#) [L091S224LF](#) [L061S220LF](#) [BCN164A562J7](#) [62PR25KLF](#) [56BW-FIFTY-PKG](#) [CHP1501R00FLF](#) [BCN164AB470J7](#) [898-3-R150K](#) [66XR10](#) [66XR200K](#) [66XR2K](#) [66XR50](#) [67WR1MEG](#) [67WR200KLFTB](#) [67ZR200](#) [68WR5K](#) [68XR2MEG](#) [72PXR10K](#) [72XR2.5K](#) [8109](#) [82PR25K](#) [84WR10KTR](#) [OPB660N](#) [OPB748WZ](#) [OPB870T55](#) [OPI1266](#) [P110KV1-0Y20BR50K](#) [JANTX4N24A](#) [89XHR10K](#) [L083C101](#) [91XR5K](#) [SML100M12MSF](#) [PFC-W0805LF-03-2870-B](#) [2627](#) [CR200L.5](#) [RC07GF220J](#) [RC20GF272J](#) [RC55LF-D-196R-B-B](#) [HM00-01800](#) [HM71-10220LFTR](#) [3371R5KL.25](#) [L083C122](#) [W23-330RJI](#) [WH25-47RJI](#) [040585XM](#) [6679-420-0](#) [OP231](#) [OPB471T11](#) [OPB817Z](#)