

# Power Inductors

## Model HA72L-1265 series



### Features:

- Operating Temperature Range  $-55^{\circ}\text{C}$  to  $+155^{\circ}\text{C}$
- Ambient Temperature, Maximum  $+115^{\circ}\text{C}$
- Temperature Rise,  $40^{\circ}\text{C}$
- RoHS Compliant
- AEC-Q200 Certified

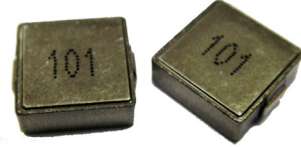

### Schematic

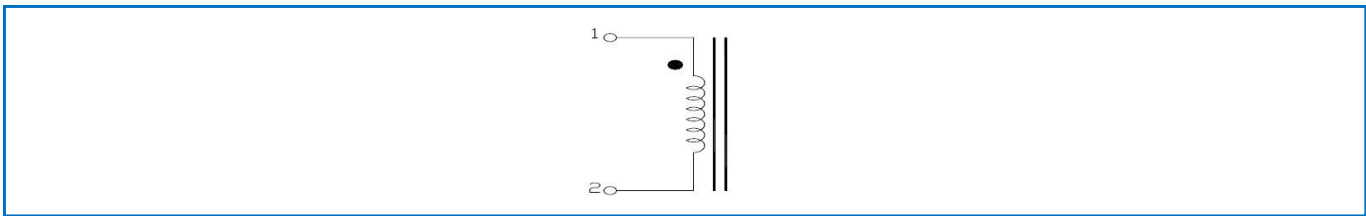

### Specifications @ 25°C

Part Number	Inductance ( $\mu\text{H} \pm 20\%$ @0A)	DCR ( $\text{m}\Omega$ ) Typ	DCR ( $\text{m}\Omega$ ) Max	I <sub>rms</sub> (A)	I <sub>sat</sub> (A)	Part Number	Inductance ( $\mu\text{H} \pm 20\%$ @0A)	DCR ( $\text{m}\Omega$ ) Typ.	DCR ( $\text{m}\Omega$ ) Max	I <sub>rms</sub> (A)	I <sub>sat</sub> (A)
HA72L-1265R10LFTR	0.10	0.47	0.50	60.0	80.0	HA72L-12652R8LFTR	2.80	4.20	4.80	20.0	25.0
HA72L-1265R15LFTR	0.15	0.53	0.60	55.0	80.0	HA72L-12653R3LFTR	3.30	5.70	6.80	18.0	35.0
HA72L-1265R22LFTR	0.22	0.63	0.70	53.0	80.0	HA72L-12654R2LFTR	4.20	5.80	7.20	11.0	28.0
HA72L-1265R30LFTR	0.30	0.70	0.80	48.0	72.0	HA72L-12654R7LFTR	4.70	9.30	11.20	13.5	30.0
HA72L-1265R33LFTR	0.33	0.83	0.90	46.0	65.0	HA72L-12655R6LFTR	5.60	11.80	12.80	12.0	26.5
HA72L-1265R40LFTR	0.40	0.90	1.00	44.0	64.0	HA72L-12656R8LFTR	6.80	13.10	14.00	11.5	16.5
HA72L-1265R47LFTR	0.47	1.00	1.20	41.0	63.0	HA72L-12658R2LFTR	8.20	14.50	15.50	10.5	16.0
HA72L-1265R56LFTR	0.56	1.20	1.40	37.0	62.0	HA72L-1265100LFTR	10.0	15.80	16.80	10.0	15.5
HA72L-1265R68LFTR	0.68	1.40	1.60	35.0	60.0	HA72L-1265120LFTR	12.0	23.00	26.00	9.0	14.0
HA72L-1265R82LFTR	0.82	1.60	1.90	33.0	50.0	HA72L-1265150LFTR	15.0	25.00	29.00	6.0	9.0
HA72L-12651R0LFTR	1.00	1.70	2.00	32.0	49.0	HA72L-1265220LFTR	22.0	34.00	39.50	5.0	7.5
HA72L-12651R2LFTR	1.20	2.10	2.50	30.0	48.0	HA72L-1265330LFTR	33.0	55.00	65.00	4.0	6.0
HA72L-12651R5LFTR	1.50	2.50	3.00	27.0	45.0	HA72L-1265470LFTR	47.0	80.00	92.00	3.0	5.0
HA72L-12651R8LFTR	1.80	2.80	3.20	24.0	41.0	HA72L-1265680LFTR	68.0	122.0	134.0	2.0	3.5
HA72L-12652R2LFTR	2.20	3.50	4.20	22.0	40.0						

- Notes: (1) I<sub>sat</sub> is the saturation current at which inductance rolls off approximately 30% from its initial (zero DC)  
 (2) I<sub>rms</sub> is the approximate current at which  $\Delta T = 40^{\circ}\text{C}$   
 (3) Operating Temperature Range  $-55^{\circ}\text{C}$  to  $+155^{\circ}\text{C}$   
 (4) Test conditions for all case sizes is 100kHz @ 1V

#### General Note

TT Electronics reserves the right to make changes in product specification without notice or liability. All information is subject to TT Electronics' own data and is considered accurate at time of going to print.

TT Electronics | BI Technologies  
 A-1445, Jalan Tanjung Api

25050 Kuantan Pahang Darul Makmur, Malaysia | Ph: +60 9 565 8888  
[www.ttelectronicsmagnetics.com/customer-service-enquiry](http://www.ttelectronicsmagnetics.com/customer-service-enquiry)

### Electrical Specifications

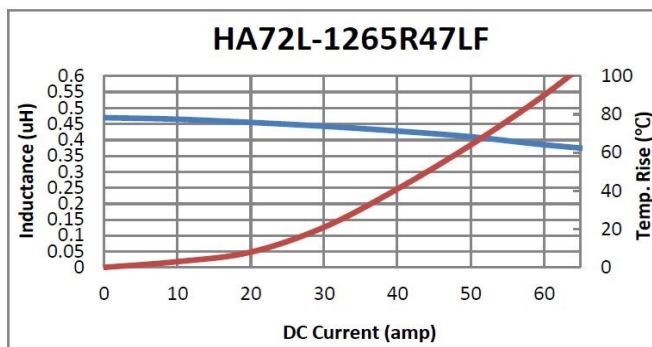
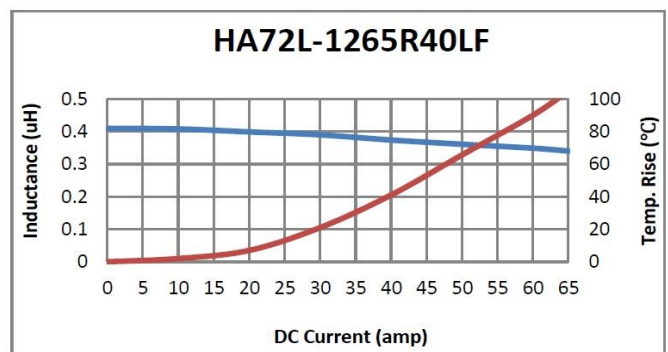
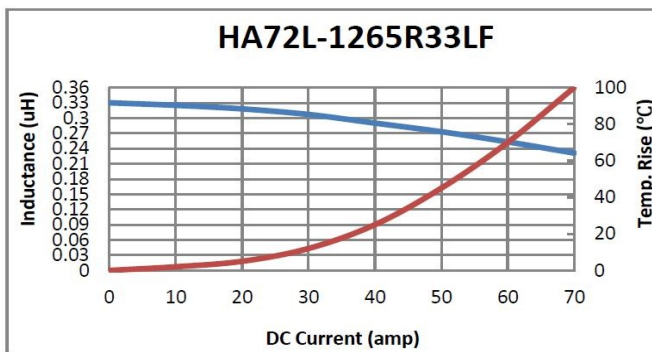
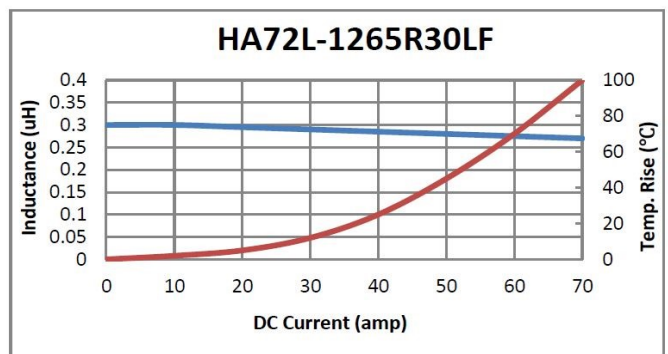
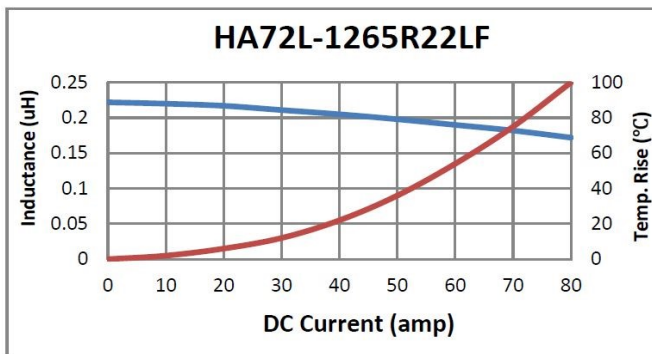
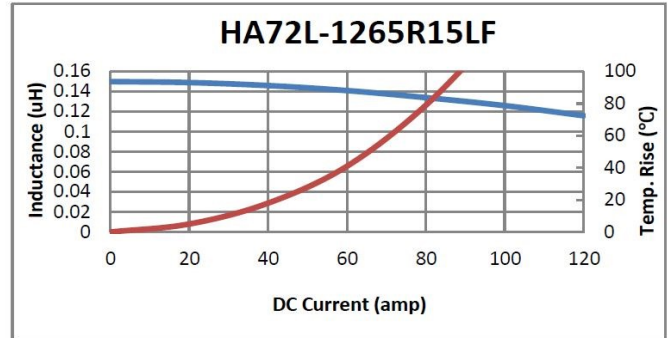
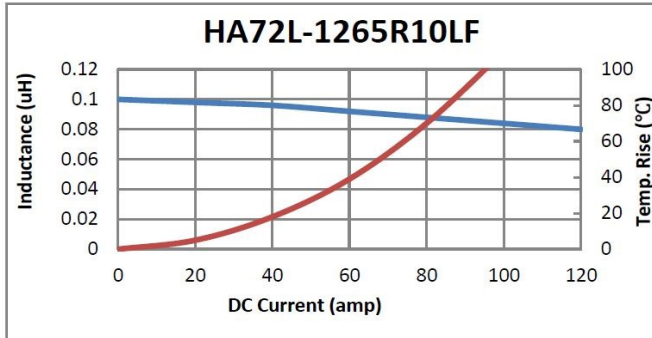

General Note  
 TT Electronics reserves the right to make changes in product specification without notice or liability. All information is subject to TT Electronics' own data and is considered accurate at time of going to print.

TT Electronics | BI Technologies  
 A-1445, Jalan Tanjung Api  
 25050 Kuantan Pahang Darul Makmur, Malaysia | Ph: +60 9 565 8888  
[www.ttelectronicsmagnetics.com/customer-service-enquiry](http://www.ttelectronicsmagnetics.com/customer-service-enquiry)

### Electrical Characteristics

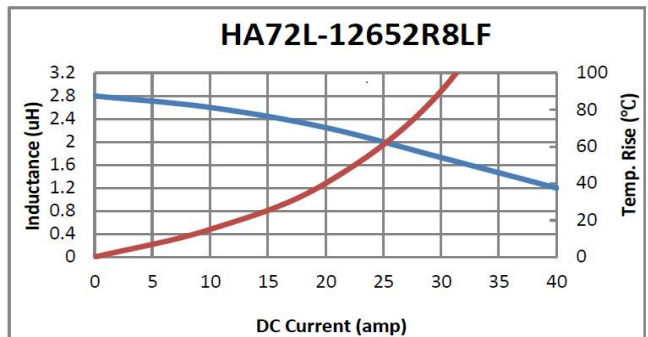
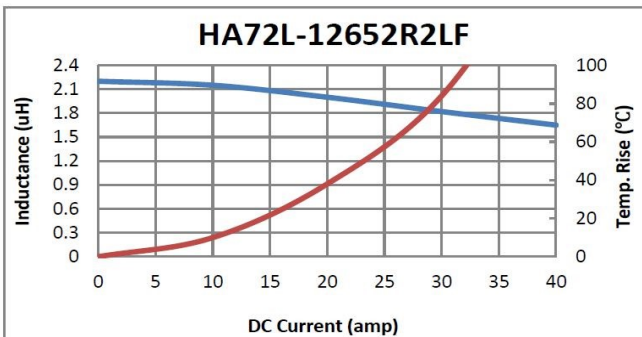
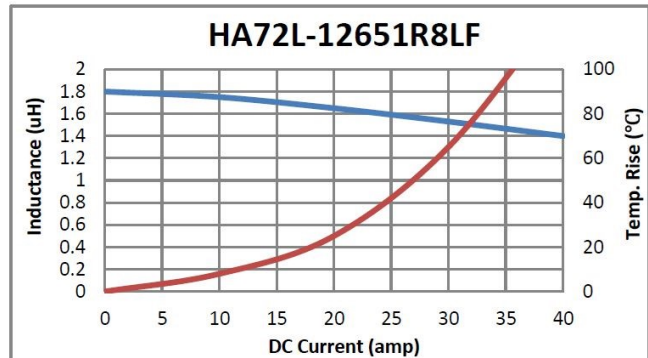
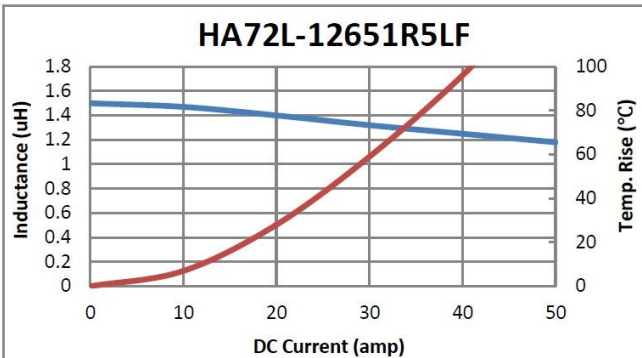
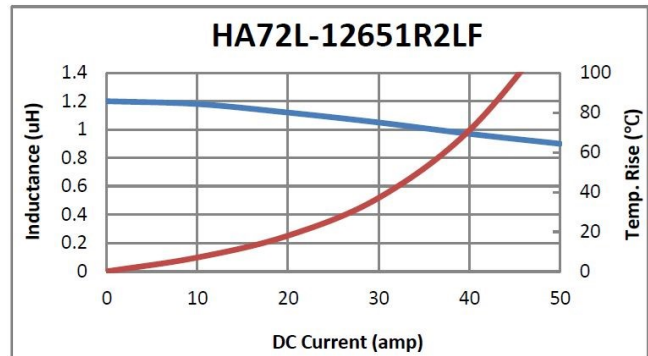
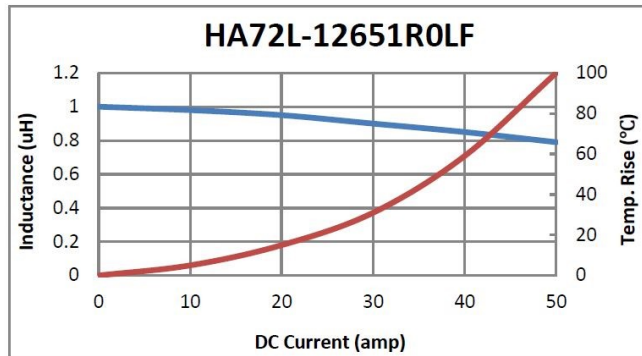
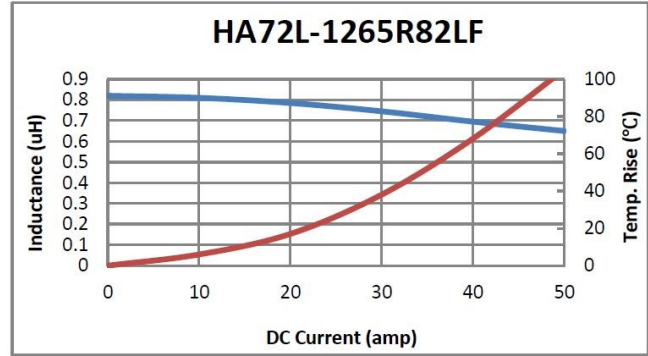
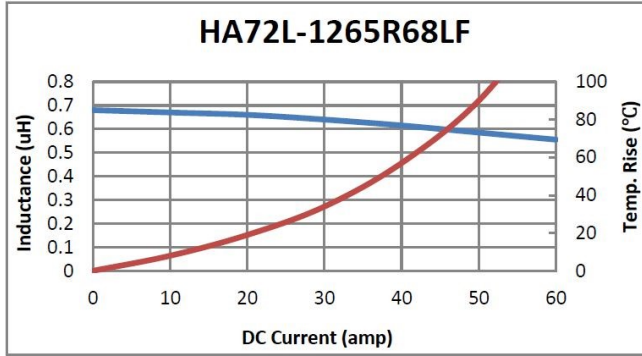

General Note  
 TT Electronics reserves the right to make changes in product specification without notice or liability. All information is subject to TT Electronics' own data and is considered accurate at time of going to print.

TT Electronics | BI Technologies  
 A-1445, Jalan Tanjung Api  
 25050 Kuantan Pahang Darul Makmur, Malaysia | Ph: +60 9 565 8888  
[www.ttelectronicsmagnetics.com/customer-service-enquiry](http://www.ttelectronicsmagnetics.com/customer-service-enquiry)

### Electrical Characteristics

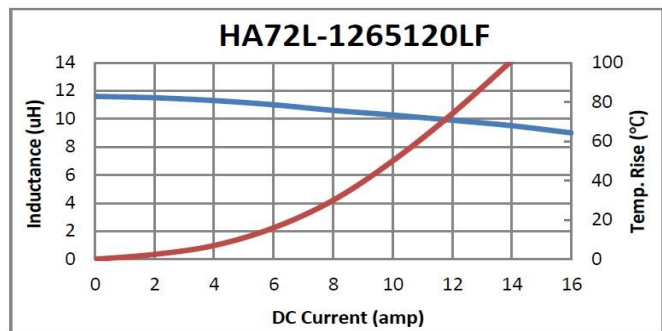
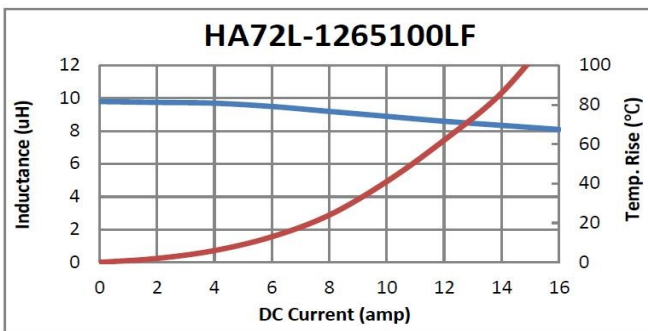
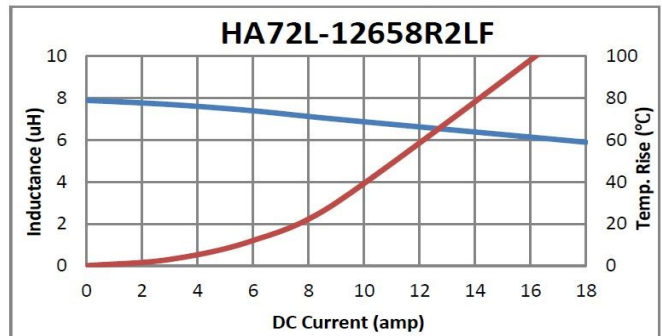
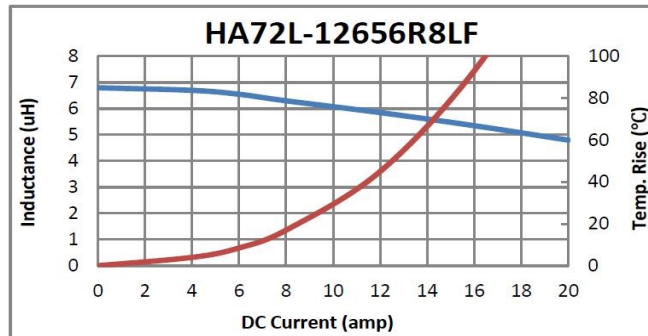
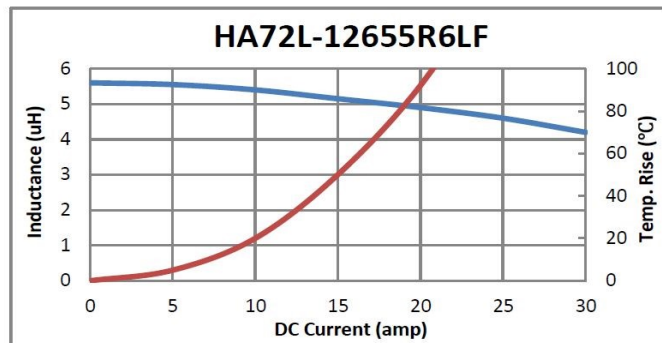
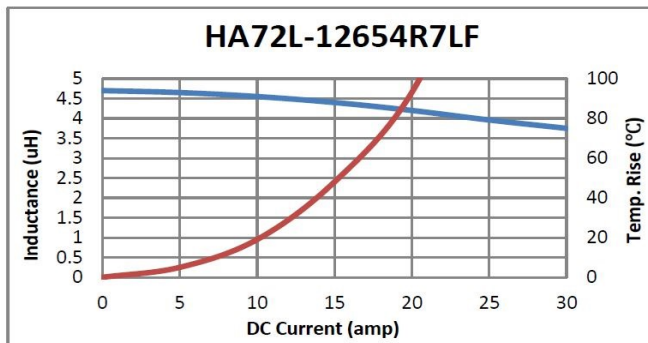
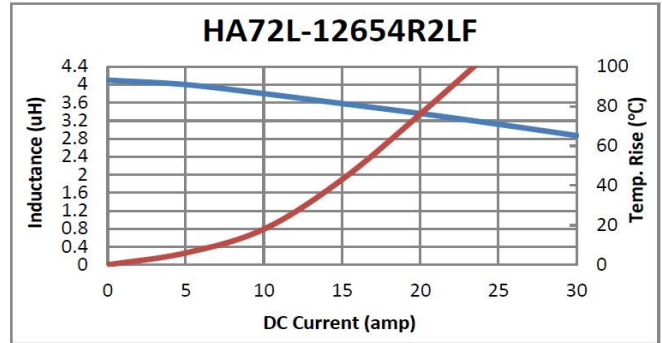
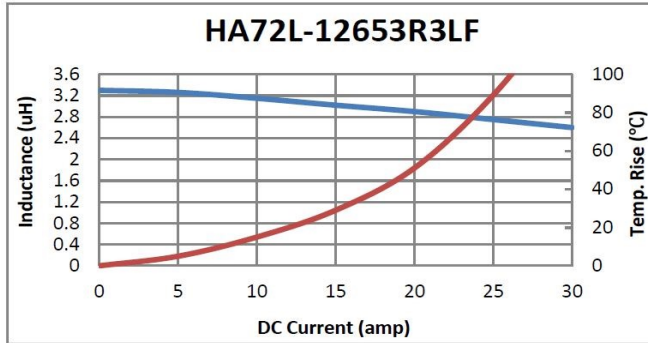

General Note  
 TT Electronics reserves the right to make changes in product specification without notice or liability. All information is subject to TT Electronics' own data and is considered accurate at time of going to print.

TT Electronics | BI Technologies  
 A-1445, Jalan Tanjung Api  
 25050 Kuantan Pahang Darul Makmur, Malaysia | Ph: +60 9 565 8888  
[www.ttelectronicsmagnetics.com/customer-service-enquiry](http://www.ttelectronicsmagnetics.com/customer-service-enquiry)



# Power Inductors

## Model HA72L-1265 series

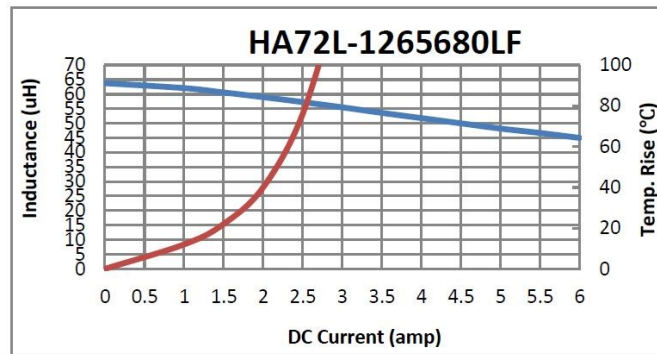
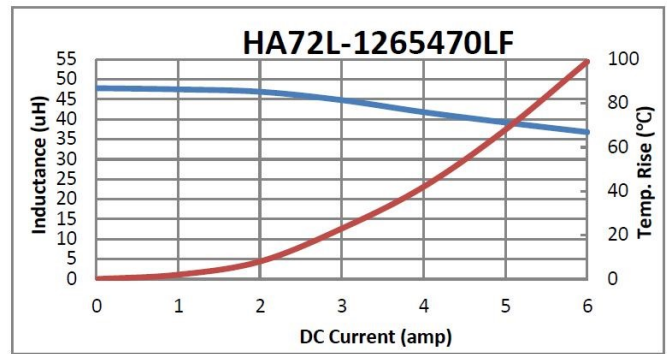
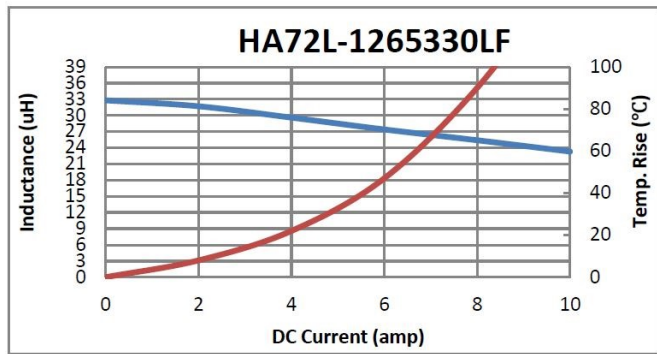
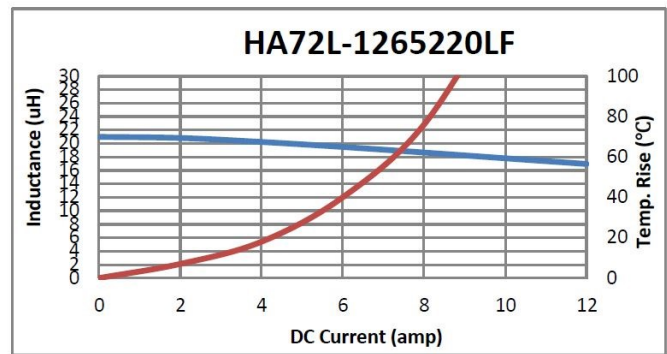
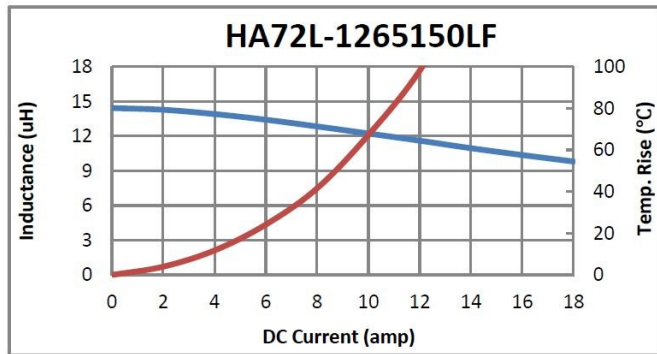

General Note  
 TT Electronics reserves the right to make changes in product specification without notice or liability. All information is subject to TT Electronics' own data and is considered accurate at time of going to print.

TT Electronics | BI Technologies  
 A-1445, Jalan Tanjung Api  
 25050 Kuantan Pahang Darul Makmur, Malaysia | Ph: +60 9 565 8888  
[www.ttelectronicsmagnetics.com/customer-service-enquiry](http://www.ttelectronicsmagnetics.com/customer-service-enquiry)

### Outline dimensions (mm)

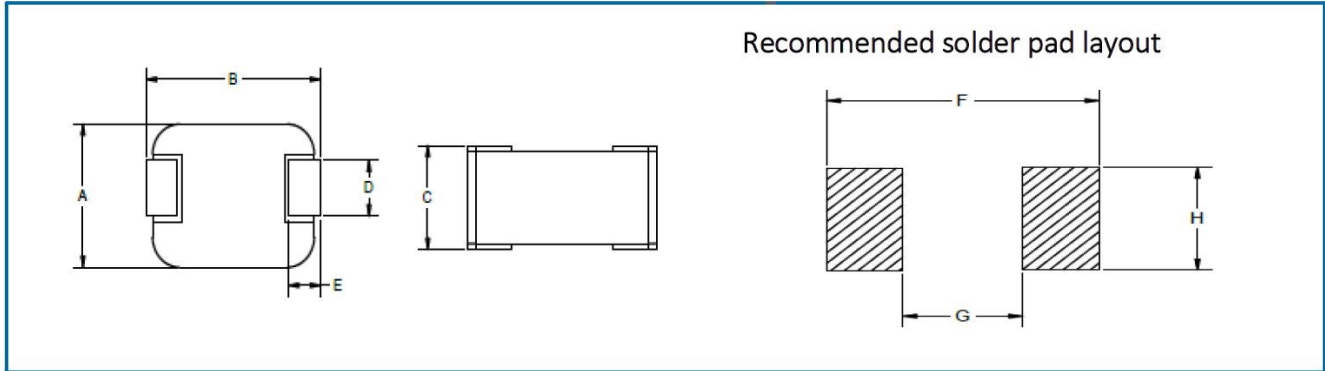

CASE SIZE	A(mm)	B(mm)	C(mm)	D(mm)	E(mm)	F(mm)	G(mm)	H(mm)
1265 series	12.8 ± 0.3	13.5 ± 0.5	6.5	3.5 ± 0.5	2.5 ± 0.5	15	6	5

### Packaging

Standard:	Embossed Tape and Reel		
	Reel:	Diameter	All case size = 13" (330mm)
	Capacity	Case size 1265 = 400 units	

### Ordering information

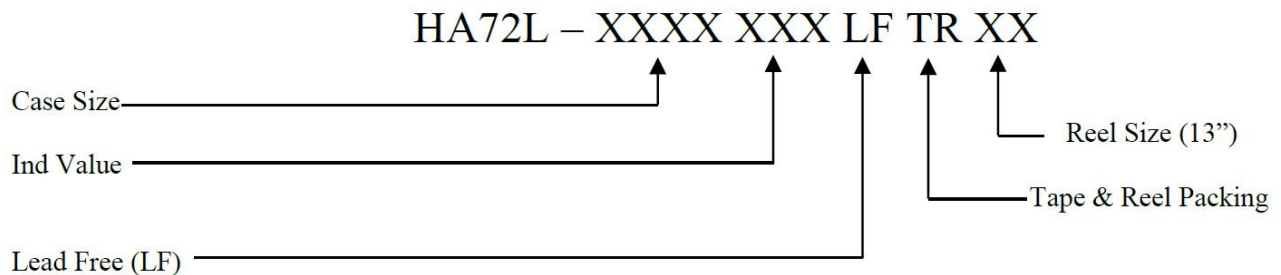

## X-ON Electronics

Largest Supplier of Electrical and Electronic Components

*Click to view similar products for [Fixed Inductors](#) category:*

*Click to view products by [TT Electronics](#) manufacturer:*

Other Similar products are found below :

[CR43NP-680KC](#) [CR54NP-820KC](#) [CR54NP-8R5MC](#) [CTX32CT-100](#) [70F224AI](#) [MGDQ4-00004-P](#) [MHL1ECTTP18NJ](#) [MHL1JCTTD12NJ](#)  
[PE-51506NL](#) [PE-53601NL](#) [PE-53602NL](#) [PE-53630NL](#) [PE-53824SNLT](#) [PE-62892NL](#) [PE-92100NL](#) [PG0434.801NLT](#) [PG0936.113NLT](#)  
[9310-16](#) [PM06-2N7](#) [PM06-39NJ](#) [A01TK](#) [1206CS-471XJ](#) [HC2-2R2TR](#) [HC2LP-R47-R](#) [HC3-2R2-R](#) [1206CS-151XG](#) [RCH664NP-140L](#)  
[RCH664NP-4R7M](#) [RCH8011NP-221L](#) [RCP1317NP-332L](#) [RCP1317NP-391L](#) [RCR1010NP-470M](#) [RCR110DNP-331L](#) [DH2280-4R7M](#)  
[DS1608C-106](#) [ASPI-4020HI-R10M-T](#) [B10TJ](#) [B82477P4333M](#) [B82498B3101J000](#) [B82498B3680J000](#) [ELJ-RE27NJF2](#) [1812CS-153XJ](#)  
[1812CS-183XJ](#) [1812CS-223XJ](#) [1812LS-104XJ](#) [1812LS-105XJ](#) [1812LS-124XJ](#) [1812LS-154XJ](#) [1812LS-223XJ](#) [1812LS-224XJ](#)