

NPN Silicon Phototransistors

Types OP800WSL, OP801WSL, OP802WSL

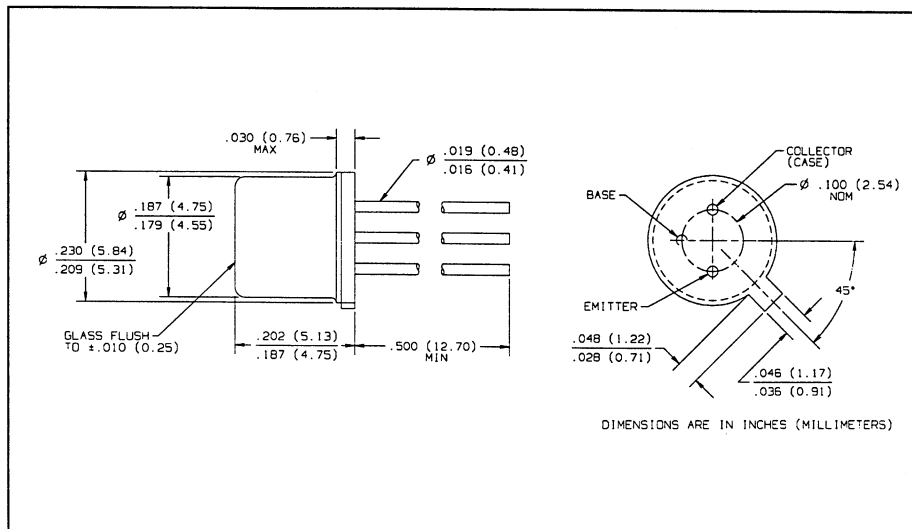
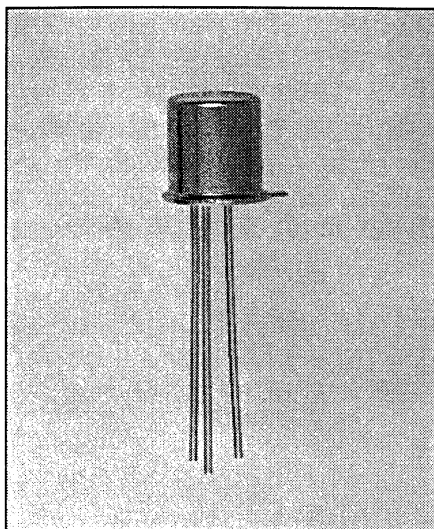

Features

- Wide receiving angle
- Variety of sensitivity ranges
- Enhanced temperature range
- TO-18 hermetically sealed package
- Mechanically and spectrally matched to the OP130W and OP231W series emitters

Description

The OP800WSL series device consists of an NPN silicon phototransistor mounted in a hermetically sealed package. The wide receiving angle provides relatively even reception over a large area. TO-18 packages offer high power dissipation and superior hostile environment operation.

Replaces

OP800W and K5201 series

Absolute Maximum Ratings ($T_A = 25^\circ\text{C}$ unless otherwise noted)

Collector-Emitter Voltage	30 V
Emitter-Collector Voltage	5.0 V
Continuous Collector Current	50 mA
Storage Temperature Range	-65°C to $+150^\circ\text{C}$
Operating Temperature Range	-65°C to $+125^\circ\text{C}$
Lead Soldering Temperature [1/16 inch (1.6 mm) from case for 5 sec. with soldering iron]	$260^\circ\text{C}^{(1)}$
Power Dissipation	$250\text{mW}^{(2)}$

Notes:

- (1) RMA flux is recommended. Duration can be extended to 10 sec. max. when flow soldering.
- (2) Derate linearly $2.5\text{mW}/^\circ\text{C}$ above 25°C .
- (3) Junction temperature maintained at 25°C .
- (4) Light source is an unfiltered tungsten bulb operating at $CT = 2870\text{K}$ or equivalent infrared source.

Typical Performance Curves

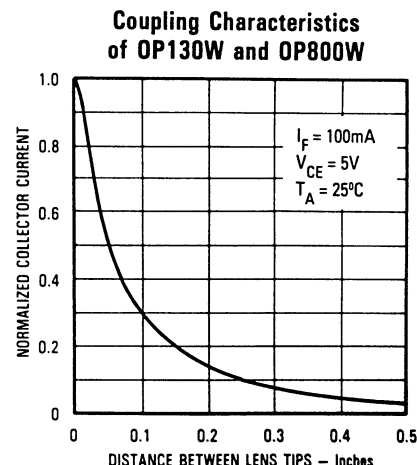
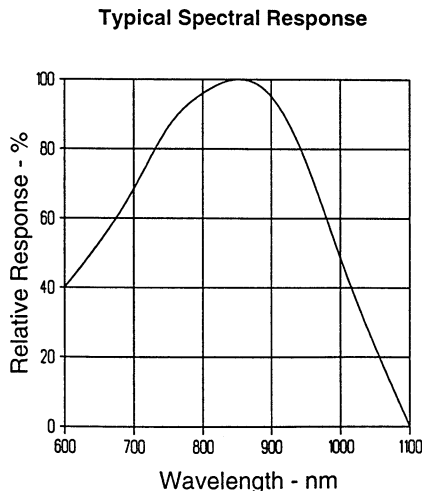

Types OP800WSL, OP801WSL, OP802WSL

Electrical Characteristics ($T_A = 25^\circ\text{C}$ unless otherwise noted)

SYMBOL	PARAMETER	MIN	TYP	MAX	UNITS	TEST CONDITIONS
$I_{C(ON)}^{(3)}$	On-State Collector Current	OP800WSL OP801WSL OP802WSL	0.3 0.5 2.5		mA mA mA	$V_{CE} = 5\text{ V}, E_e = 5\text{ mW/cm}^2(4)$
I_{CEO}	Collector Dark Current			100	nA	$V_{CE} = 10\text{ V}, E_e = 0$
$V_{(BR)CEO}$	Collector-Emitter Breakdown Voltage	30			V	$I_C = 100\ \mu\text{A}$
$V_{(BR)ECO}$	Emitter-Collector Breakdown Voltage	5.0			V	$I_E = 100\ \mu\text{A}$
$V_{CE(SAT)}^{(3)}$	Collector-Emitter Saturation Voltage			0.40	V	$I_C = 0.15\text{ mA}, E_e = 0.5\text{ mW/cm}^2(4)$
t_r	Rise Time		7.0		μs	$V_{CC} = 5\text{ V}, I_C = 0.80\text{ mA}, R_L = 100\ \Omega, \text{ See Test Circuit}$
t_f	Fall Time		7.0		μs	

PHOTOSENSORS

Typical Performance Curves

Collector Dark Current vs. Ambient Temperature

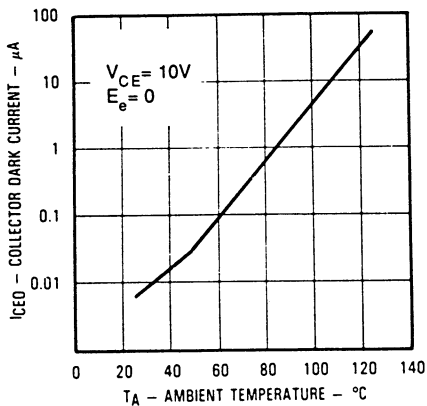

Normalized Collector Current vs. Ambient Temperature

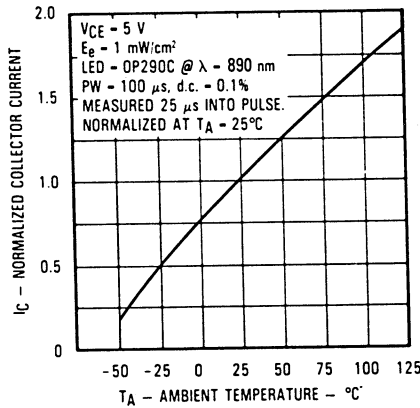

Collector Current vs. Irradiance

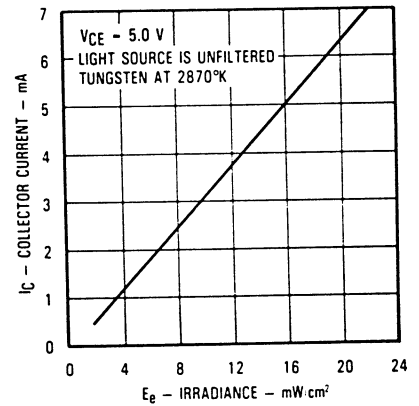

Rise and Fall Time vs. Load Resistance

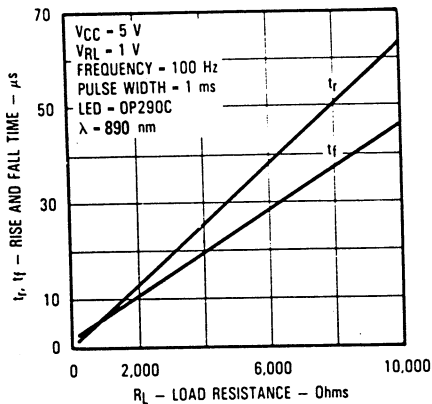

Normalized Collector Current vs. Angular Displacement

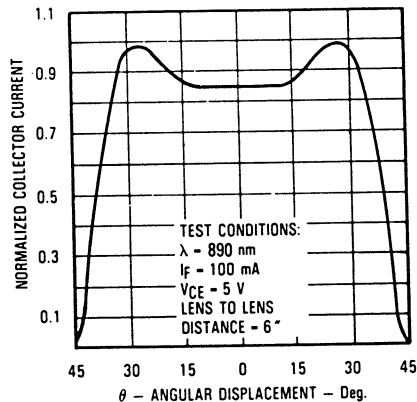

Switching Time Test Circuit

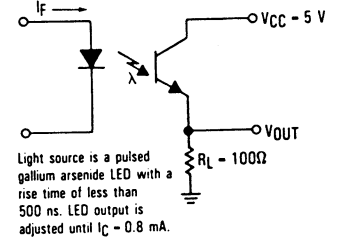

Optek reserves the right to make changes at any time in order to improve design and to supply the best product possible.

Optek Technology, Inc. 1215 W. Crosby Road Carrollton, Texas 75006 (972)323-2200 Fax (972)323-2396

X-ON Electronics

Largest Supplier of Electrical and Electronic Components

Click to view similar products for [Phototransistors](#) category:

Click to view products by [TT Electronics](#) manufacturer:

Other Similar products are found below :

[LTR-5576D](#) [PT17-21B/L41/TR8](#) [PT908-7B-F](#) [ASDL-6620-C22](#) [OED-ST-8LR2](#) [OED-STR44B90-TR](#) [SD5410-109](#) [PT26-21C/CT](#) [PT15-21B-TR8](#) [PT-IC-AC-3528-520](#) [PT-IC-BC-3528-550](#) [MHT153PTBT](#) [MHS153PTBT](#) [PT5529B/L2/H2-F](#) [PT91-21C/TR10](#) [BP 103-3/4](#) [BPX 38-3](#) [BPY 62](#) [KPS-3227SP1C](#) [L-53P3BT](#) [L-53P3C](#) [L-93DP3BT](#) [L-93DP3C](#) [LL-503PTC2E-1AD](#) [LL-S150PTC-1A](#) [LL-S150PTD-1A](#) [SFH 320](#) [SFH 320-3](#) [SFH 320 FA](#) [OP508FA](#) [TEMT1030](#) [LTR-301](#) [PGM5516-MP](#) [PGM5526-MP](#) [PGM5549](#) [PGM5637D](#) [VTT7125H](#) [VEMT4700F-GS08](#) [PT19-21B/L41/TR8](#) [KP-2012P3C](#) [TEKT5400S](#) [SD1410-128L](#) [SFH 313 FA-3/4](#) [SFH 313 FA-2/3](#) [SFH 320-4-Z](#) [SFH 309 FA-5/6](#) [PT4800FE000F](#) [SFH 309-5/6](#) [SFH 3410-1/2-Z](#) [SFH 3410R](#)