

# NPN Silicon Photodarlington Type OP830WSL

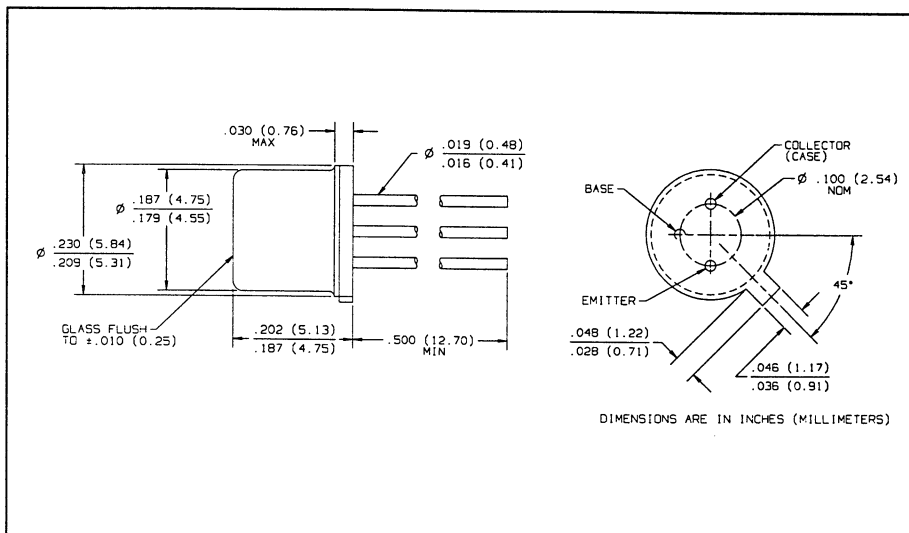
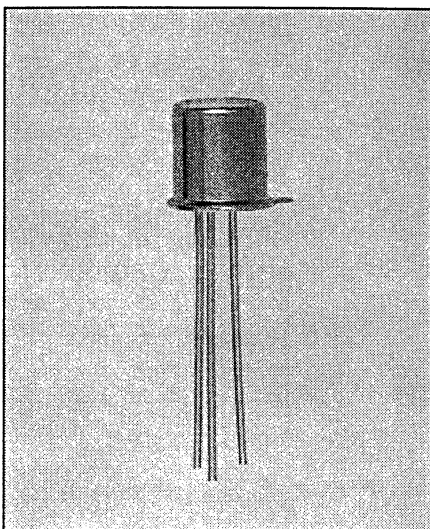

## Features

- Wide receiving angle
- Enhanced temperature range
- Excellent thermal characteristics
- TO-18 hermetically sealed package
- Mechanically and spectrally matched to the OP130W and OP231W series of infrared emitting diodes

## Description

The OP830WSL consists of an NPN silicon photodarlington mounted in a hermetically sealed package. The wide receiving angle provides relatively even reception over a large area.

Photodarlington devices are normally used in applications where light signal levels are low and more current gain is needed than is possible with phototransistors. TO-18 packages offer high power dissipation and superior hostile environment operation.

## Replaces

OP830W and K9030 series

## Absolute Maximum Ratings ( $T_A = 25^\circ\text{C}$ unless otherwise noted)

Collector-Emitter Voltage .....	15 V
Emitter-Collector Voltage .....	5 V
Continuous Collector Current .....	50 mA
Storage Temperature Range .....	$-65^\circ\text{C}$ to $+150^\circ\text{C}$
Operating Temperature Range .....	$-55^\circ\text{C}$ to $+125^\circ\text{C}$
Lead Soldering Temperature [1/16 inch (1.6 mm) from case for 5 sec. with soldering iron] .....	$260^\circ\text{C}^{(1)}$
Power Dissipation .....	$250\text{ mW}^{(2)}$

### Notes:

- (1) RMA flux is recommended. Duration can be extended to 10 sec. max. when flow soldering.
- (2) Derate linearly  $2.5\text{ mW}/^\circ\text{C}$  above  $25^\circ\text{C}$ .
- (3) Junction temperature maintained at  $25^\circ\text{C}$ .
- (4) Light source is an unfiltered tungsten bulb operating at  $CT = 2870\text{ K}$  or equivalent infrared source.

## Typical Performance Curves

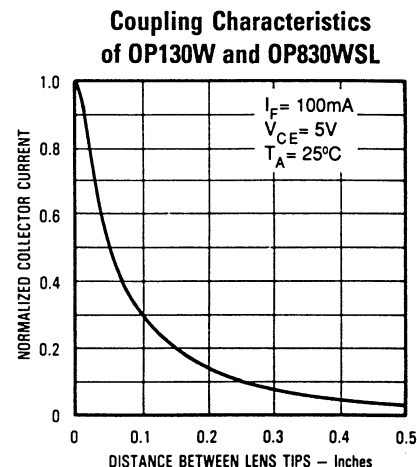
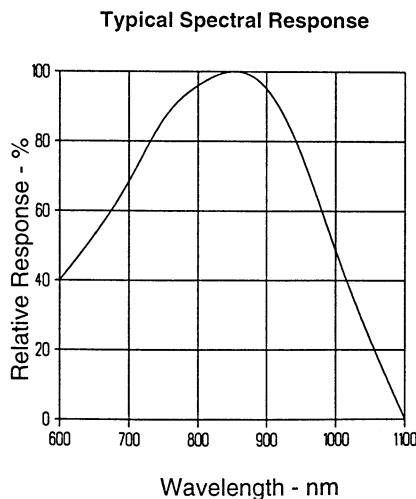

# OP830WSL

Electrical Characteristics ( $T_A = 25^\circ\text{C}$  unless otherwise noted)

SYMBOL	PARAMETER	MIN	TYP	MAX	UNITS	TEST CONDITIONS
$I_{C(ON)}^{(3)}$	On-State Collector Current	4			mA	$V_{CE} = 5\text{ V}$ , $E_e = 0.5\text{ mW/cm}^2^{(4)}$
$I_{CEO}$	Collector Dark Current			1.0	$\mu\text{A}$	$V_{CE} = 10\text{ V}$
$V_{(BR)CEO}$	Collector-Emitter Breakdown Voltage	15			V	$I_C = 100\ \mu\text{A}$
$V_{(BR)ECO}$	Emitter-Collector Breakdown Voltage	5.0			V	$I_E = 100\ \mu\text{A}$
$V_{CE(SAT)}^{(3)}$	Collector-Emitter Saturation Voltage			1.20	V	$I_C = 1.0\text{ mA}$ , $E_e = 0.5\text{ mW/cm}^2^{(4)}$

## Typical Performance Curves

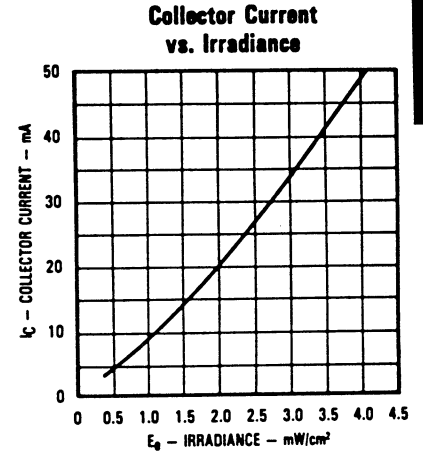
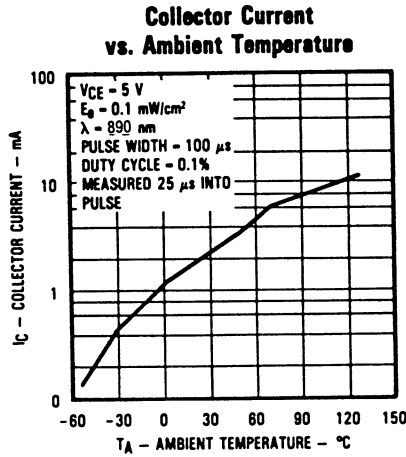
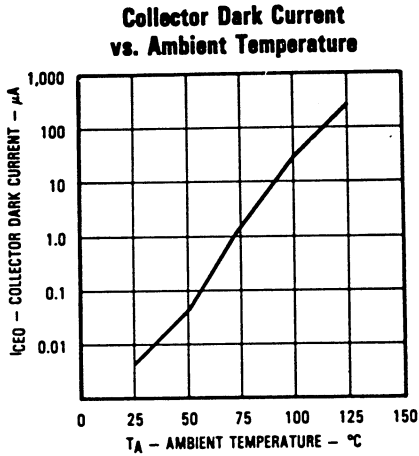

PHOTOSENSORS

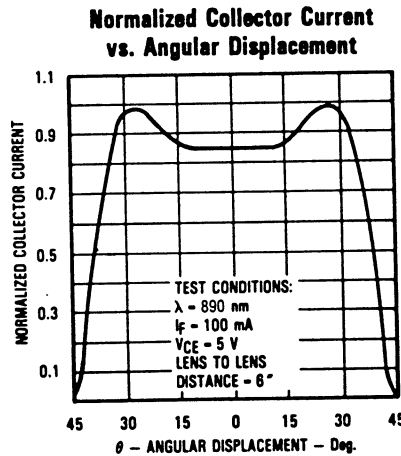
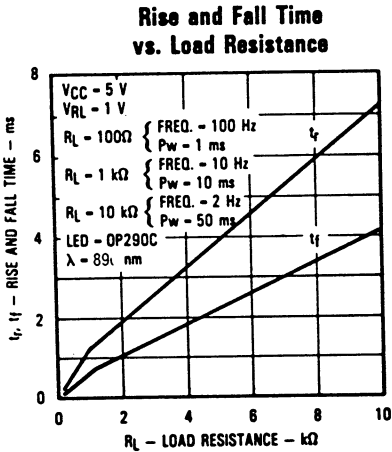

## Switching Time Test Circuit

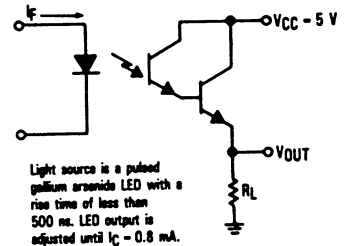

## X-ON Electronics

Largest Supplier of Electrical and Electronic Components

*Click to view similar products for [Phototransistors](#) category:*

*Click to view products by [TT Electronics](#) manufacturer:*

Other Similar products are found below :

[LTR-5576D](#) [PT17-21B/L41/TR8](#) [PT908-7B-F](#) [ASDL-6620-C22](#) [OED-ST-8LR2](#) [OED-STR44B90-TR](#) [SD5410-109](#) [PT26-21C/CT](#) [PT15-21B-TR8](#) [PT-IC-AC-3528-520](#) [PT-IC-BC-3528-550](#) [MHT153PTBT](#) [MHS153PTBT](#) [PT5529B/L2/H2-F](#) [PT91-21C/TR10](#) [BP 103-3/4](#) [BPX 38-3](#) [BPY 62](#) [KPS-3227SP1C](#) [L-53P3BT](#) [L-53P3C](#) [L-93DP3BT](#) [L-93DP3C](#) [LL-503PTC2E-1AD](#) [LL-S150PTC-1A](#) [LL-S150PTD-1A](#) [SFH 320](#) [SFH 320-3](#) [SFH 320 FA](#) [OP508FA](#) [TEMT1030](#) [LTR-301](#) [PGM5516-MP](#) [PGM5526-MP](#) [PGM5549](#) [PGM5637D](#) [VTT7125H](#) [VEMT4700F-GS08](#) [PT19-21B/L41/TR8](#) [KP-2012P3C](#) [TEKT5400S](#) [SD1410-128L](#) [SFH 313 FA-3/4](#) [SFH 313 FA-2/3](#) [SFH 320-4-Z](#) [SFH 309 FA-5/6](#) [PT4800FE000F](#) [SFH 309-5/6](#) [SFH 3410-1/2-Z](#) [SFH 3410R](#)