

# Slotted Optical Switch

## OPB610, OPB611, OPB620, OPB621



### Features:

- Non-contact switching
- Printed circuit board mounting
- Enhanced signal to noise ratio
- PIN photodiode sensor for high speed (OPB611, OPB621)
- Lead centers: 0.275" (OPB61\_) / 0.320" (OPB62\_)
- Gap: 0.150" (OPB61\_) / 0.190" (OPB62\_)

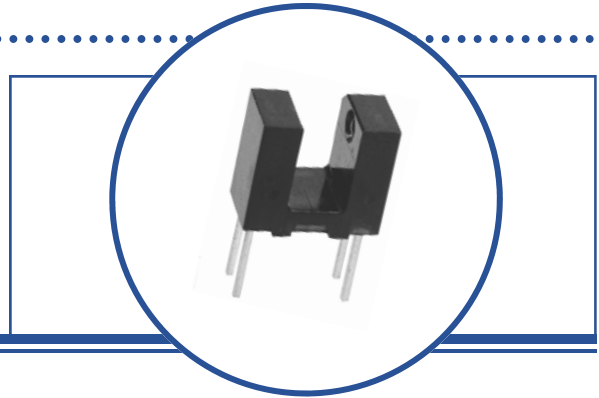

### Description:

The **OPB610** and **OPB620** slotted optical switches consist of an infrared emitting diode and an NPN silicon phototransistor with an enhanced low current roll-off to improve contrast ratio and immunity to background irradiance.

The **OPB611**, **OPB621** slotted optical switch consists of an infrared emitting diode and a PIN photodiode with a polysulfone housing that is opaque to visible light, but transmissive to infrared. The low  $t_r/t_f$  of the PIN photodiode is ideal for high-speed operation. The sensitivity to ambient radiation is minimized.

Custom electrical, wire and cabling and connectors are available. Contact your local representative or OPTEK for more information.

### Applications:

- Non-contact reflective object sensor
- Assembly line automation
- Machine automation
- Machine safety
- End of travel sensor
- Door sensor

### Ordering Information

Part Number	LED Peak Wavelength	Sensor	Slot Width / Depth	Aperture Emitter / Sensor	Lead Length / Spacing
OPB610	890 nm	Rbe Transistor	0.150" / 0.240"	0.06" / 0.06"	0.100" / 0.275"
OPB611		Diode			
OPB620	890 nm	Rbe Transistor	0.190" / 0.285"	0.06" / 0.06"	0.100" / 0.320"
OPB621		Diode			

### OPB610, OPB611

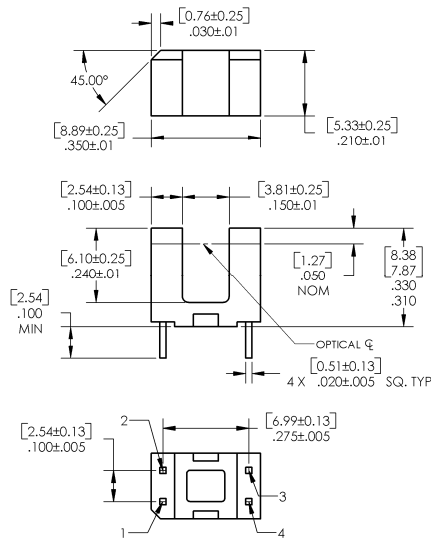

### OPB620, OPB621

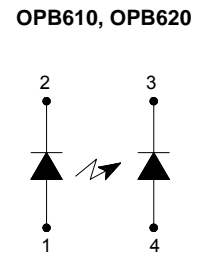
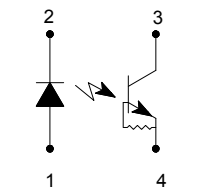
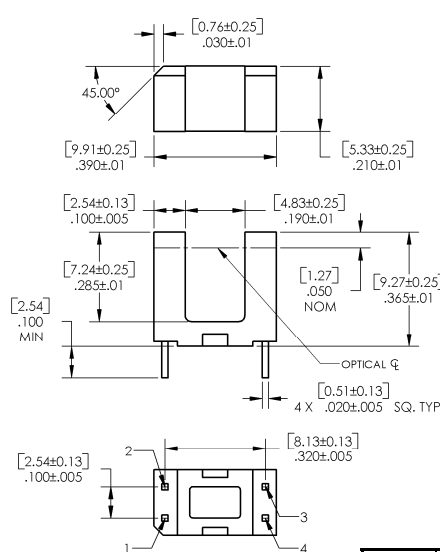

RoHS

DIMENSIONS ARE IN: [ MILLIMETERS ]  
INCHES

Pin #	LED	Pin #	Transistor / Diode
1	Anode	4	Emitter / Anode
2	Cathode	3	Collector / Cathode

OPTEK reserves the right to make changes at any time in order to improve design and to supply the best product possible.

**Absolute Maximum Ratings** ( $T_A=25^{\circ}\text{C}$  unless otherwise noted)

Storage and Operating Temperature Range	-40°C to +100° C
Lead Soldering Temperature [1/16 inch (1.6mm) from the case for 5 sec. with soldering iron] <sup>(1)</sup>	260° C

**Input Diode**

Forward DC Current	50 mA
Peak Forward Current (1 $\mu\text{s}$ pulse width, 300 pps)	3 A
Reverse DC Voltage	3 V
Power Dissipation <sup>(2)</sup>	100 mW

**Output Photodiode (OPB621)**

Reverse Breakdown Voltage	60 V
Power Dissipation	100 mW

**Output Phototransistor (OPB610, OPB620)**

Collector-Emitter Voltage	24 V
Emitter-Collector Voltage	10 mA
Collector DC Current	30 mA
Power Dissipation <sup>(3)</sup>	200 mW

**Electrical Characteristics** ( $T_A = 25^{\circ}\text{C}$  unless otherwise noted)

SYMBOL	PARAMETER	MIN	TYP	MAX	UNITS	TEST CONDITIONS
--------	-----------	-----	-----	-----	-------	-----------------

**Input Diode** (See OP240 for additional information)

$V_F$	Forward Voltage OPB610, OPB620 OPB621	- 1.15	- -	1.6 1.45	V V	$I_F = 10\text{ mA}$ $I_F = 10\text{ mA}$
$I_R$	Reverse Current	-	-	100	$\mu\text{A}$	$V_R = 3\text{ V}$

**Output Phototransistor (OPB610, OPB620)** (See OP505 for additional information)

$V_{(BR)CEO}$	Collector-Emitter Breakdown Voltage	24	-	-	V	$I_C = 100\ \mu\text{A}$
$BV_{ECO}$	Emitter-Collector Breakdown Voltage	0.4	-	-	V	$I_{CE} = 100\ \mu\text{A}$
$I_{CEO}$	Collector-Emitter Dark Current	-	-	100	nA	$V_{CE} = 5\text{ V}$

**Output Photodiode (OPB611, OPB621)** (See OP999 for additional information)

$I_D$	Dark Current	-	-	65	nA	$V_R = 30\text{ V}, E_E = 0\text{ mW}$
$V_{(BR)R}$	Reverse Breakdown Voltage	60	-	-	V	$I_R = 100\ \mu\text{A}, E_E = 0\text{ mW}$
$V_F$	Forward Voltage	-	-	1.0	V	$I_F = 1\text{ mA}, E_E = 0\text{ mW}$

**Combined**

$V_{SAT}$	Collector-Emitter Saturation Voltage OPB610, OPB620	-	-	0.4	V	$I_F = 5\text{ mA}, I_C = 100\ \mu\text{A}$
$I_{C(ON)}$	On-State Collector/Diode Current OPB610, OPB620 OPB611, OPB621	1 9	- -	- 90	mA $\mu\text{A}$	$I_F = 5\text{ mA}, V_{CE} = 5\text{ V}$ (gap unblocked) $V_R = 5\text{ V}, I_F = 20\text{ mA}$ (gap unblocked)

Notes:

- (1) RMA flux is recommended. Duration can be extended to 10 seconds maximum when flow soldering. A maximum of 20 grams force may be applied to leads when soldering.
- (2) Derate linearly 1.33 mW/°C above 25 ° C.
- (3) Derate linearly 2.0 mW/°C above 25 ° C.
- (4) Plastic body is soluble in chlorinated hydrocarbons and keytones. It is recommended that a trial exposure to flux & cleaning chemicals is performed to ensure sensor is not damaged.

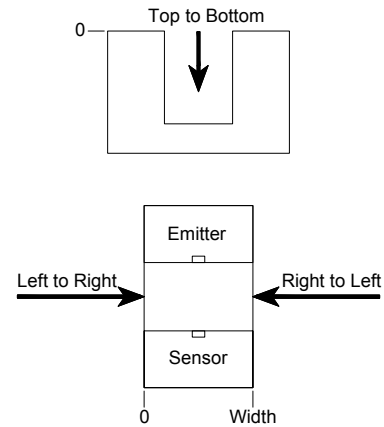
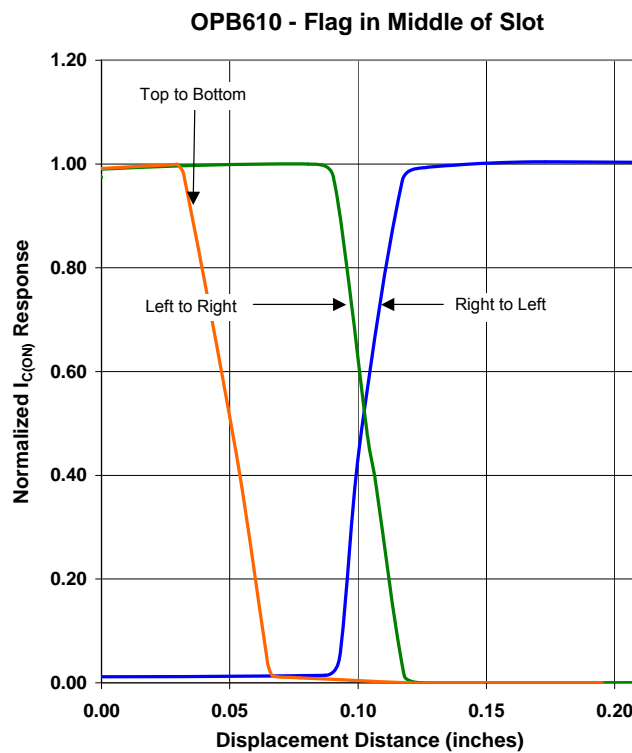
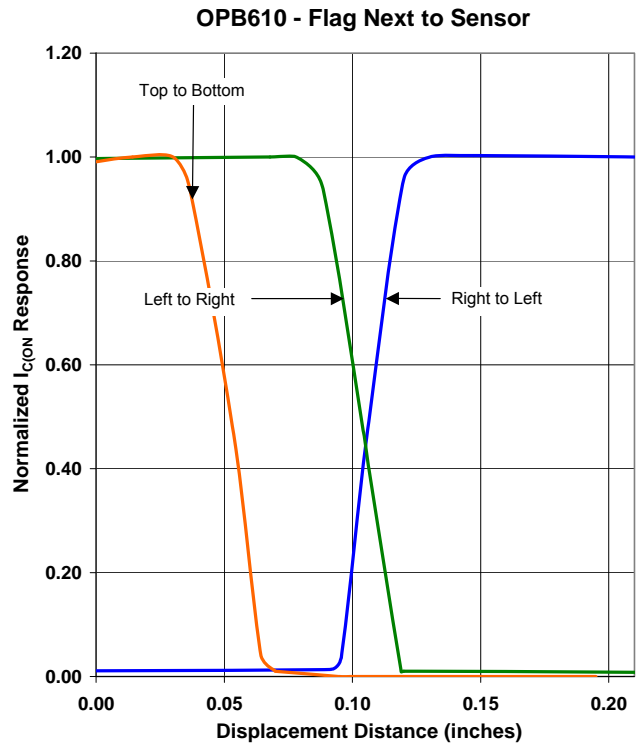
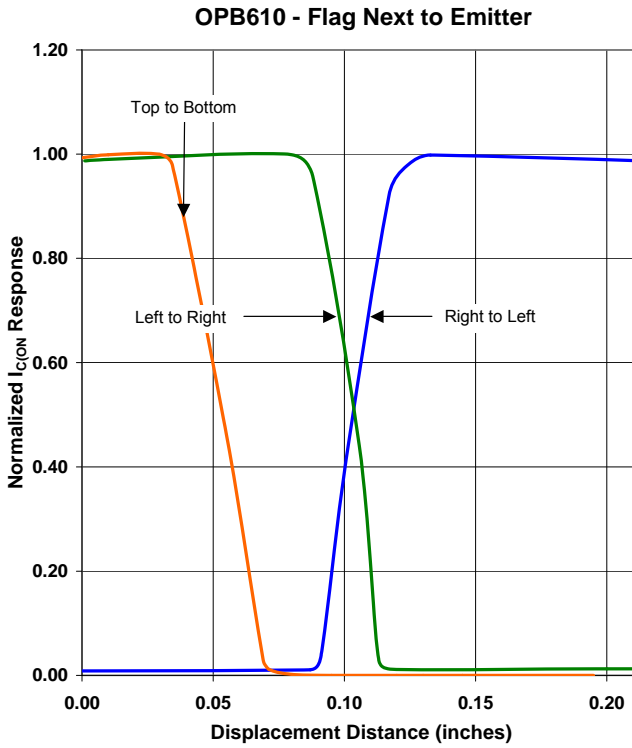

OPTEK reserves the right to make changes at any time in order to improve design and to supply the best product possible.

**OPB620 - Flag Next to Emitter**

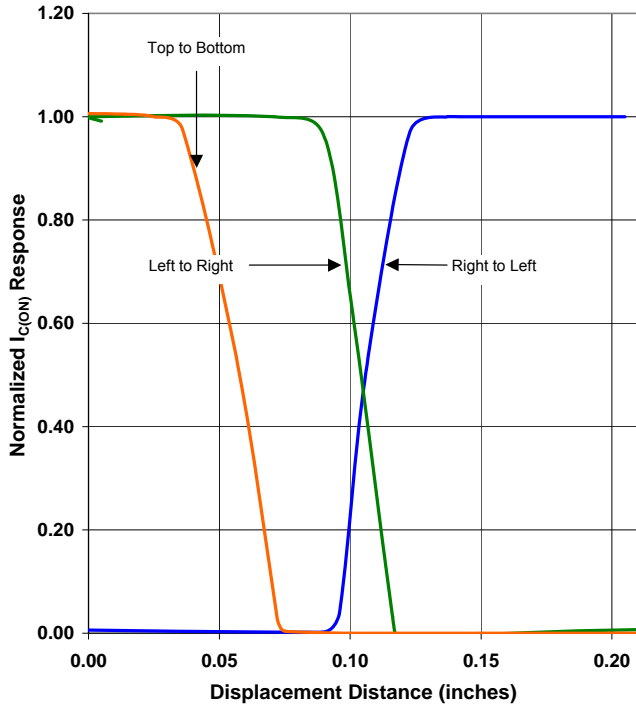

**OPB620 - Flag Next to Sensor**

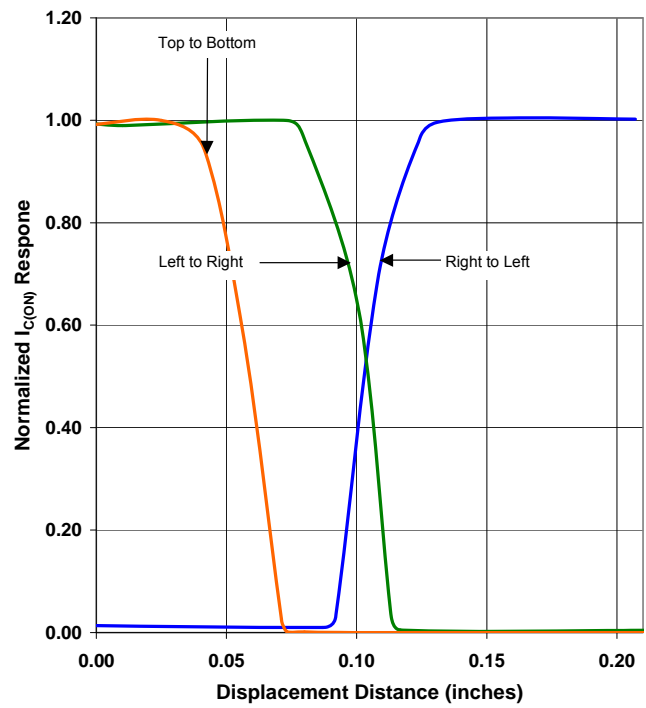

**OPB620 - Flag in Middle of Slot**

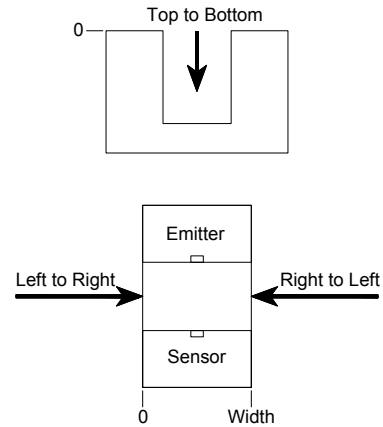
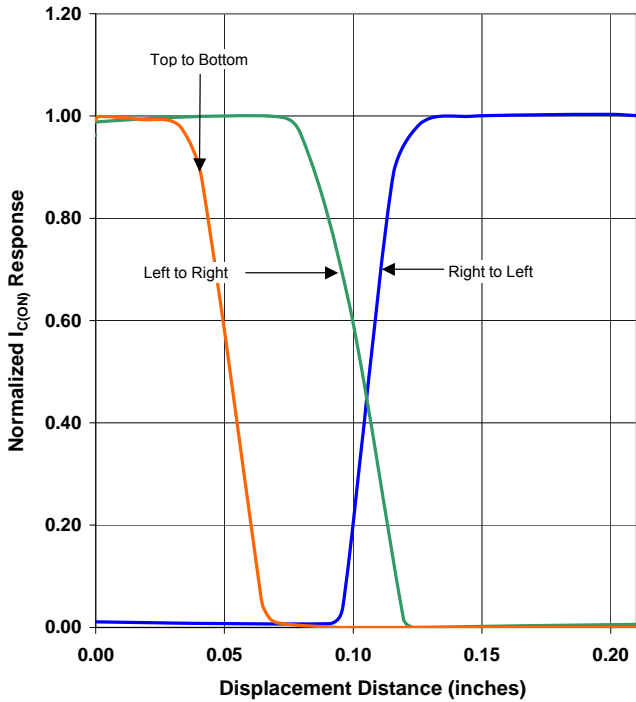

## **X-ON Electronics**

Largest Supplier of Electrical and Electronic Components

*Click to view similar products for [Optical Switches](#), [Specialised category](#):*

*Click to view products by [TT Electronics manufacturer](#):*

Other Similar products are found below :

[HOA6394-001](#) [HOA6506-001](#) [HOA6241-003](#) [HOA6109-002](#) [HOA6323-101](#) [NJL5310R-TE1](#) [EE-SPZ301](#) [OPB355T](#) [TCND5000](#) [OPB621](#)