

# Wide Gap Slotted Optical Switch

## OPB800 (L and W Series)

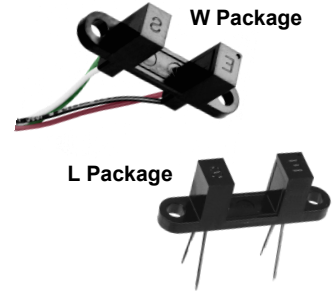

### Features:

- 0.375" (9.525 mm) wide gap
- Choice of aperture size
- Choice of minimum photocurrent
- Choice of opaque or IR transmissive shells
- Available for PCBoard mounting or with 24" 26 AWG wires

### Description:

The OPB800L series, PCBoard mounting, of wide gap switch provides the flexibility of a custom device from a standard product line, while the OPB800W series, remote mounted, switch offers 24" (610 mm) 26 AWG wire interconnect.

Building from a standard housing that utilizes a 0.375" (9.5 mm) wide slot, a user can specify the electrical output parameters, discrete shell material and the aperture width.

Housings are made from an opaque grade of injection-molded plastic that minimizes the assembly's sensitivity to visible and near-infrared ambient radiation. Discrete shells, which are exposed on parallel faces inside the device throat, are made of IR transmissive plastic (for applications where aperture contamination may occur) or of opaque plastic with aperture openings (for maximum protection against ambient light).

### Applications:

- Non-contact interruptive object sensing
- Assembly line automation
- Machine automation
- Equipment security
- Machine safety

### CONTAINS POLYSULFONE

To avoid stress cracking, we suggest using ND Industries' **Vibra-Tite** for thread-locking. **ND Vibra-Tite VC-3** evaporates fast without causing structural failure in OPTEK's molded plastics.

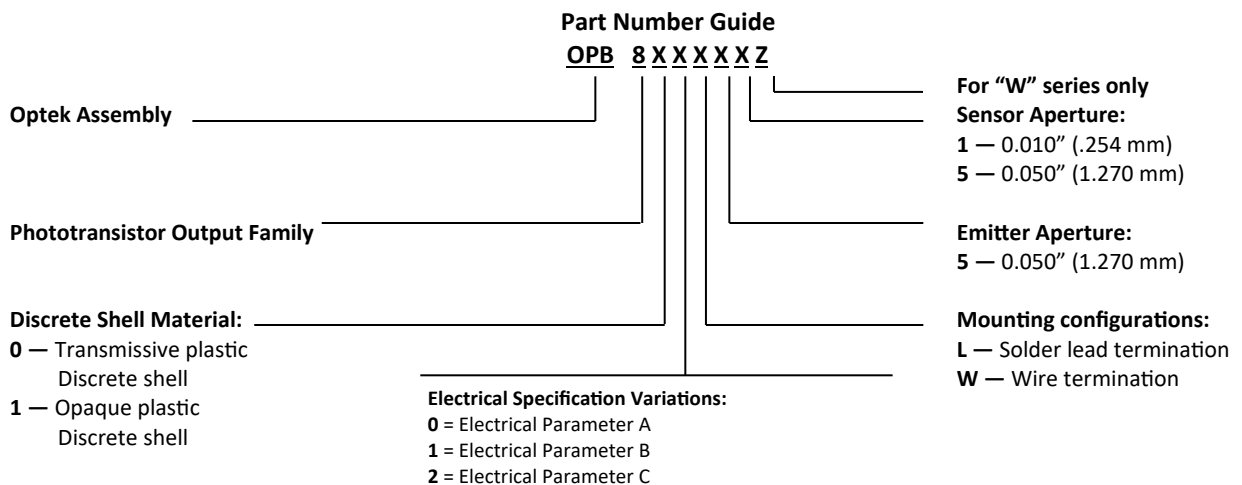

**Note:** Assemblies with 0.010" apertures are currently available with electrical parameter "A" only.  
Wires = 26AWG—24" Long

### General Note

TT Electronics reserves the right to make changes in product specification without notice or liability. All information is subject to TT Electronics' own data and is considered accurate at time of going to print.

TT Electronics | OPTEK Technology  
1645 Wallace Drive, Carrollton, TX 75006 | Ph: +1 972 323 2200  
www.ttelectronics.com | sensors@ttelectronics.com

# Wide Gap Slotted Optical Switch

## OPB800 (L and W Series)



### Electrical Specifications

#### Absolute Maximum Ratings (T<sub>A</sub> = 25 °C unless otherwise noted)

Storage and Operating Temperature L Series W Series	-40 °C to +85 °C -40 °C to +80 °C
Lead Soldering Temperature [1/16 inch (1.6 mm) from the case for 5 sec. with soldering iron] <sup>(2)</sup>	260 °C

#### Input Diode

Forward DC Current	50 mA
Peak Forward Current (1 μs pulse width, 300 pps)	3 A
Reverse DC Voltage	2 V
Power Dissipation <sup>(1)</sup>	100 mW

#### Output Phototransistor

Collector-Emitter Voltage	30 V
Emitter-Collector Voltage	5 V
Collector DC Current	30 mA
Power Dissipation <sup>(1)</sup>	100 mW

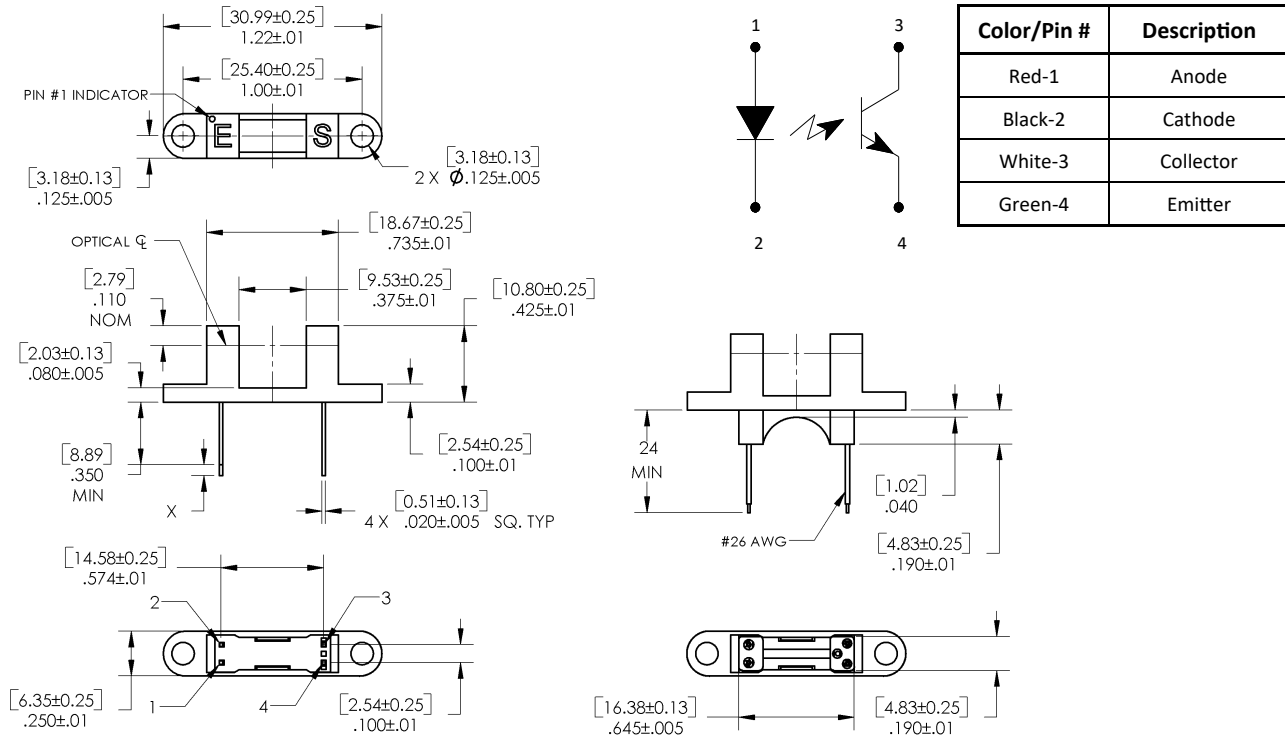

DIMENSIONS ARE IN INCHES AND [MILLIMETERS].

#### General Note

TT Electronics reserves the right to make changes in product specification without notice or liability. All information is subject to TT Electronics' own data and is considered accurate at time of going to print.

TT Electronics | OPTEK Technology  
1645 Wallace Drive, Carrollton, TX 75006 | Ph: +1 972 323 2200  
www.ttelectronics.com | sensors@ttelectronics.com

# Wide Gap Slotted Optical Switch

## OPB800 (L and W Series)



### Electrical Specifications

Electrical Characteristics ( $T_A = 25\text{ }^\circ\text{C}$  unless otherwise noted)

SYMBOL	PARAMETER	MIN	TYP	MAX	UNITS	TEST CONDITIONS
--------	-----------	-----	-----	-----	-------	-----------------

#### Input Diode

$V_F$	Forward Voltage	-	-	1.7	V	$I_F = 20\text{ mA}$
$I_R$	Reverse Current	-	-	100	$\mu\text{A}$	$V_R = 2\text{ V}$

#### Output Phototransistor

$V_{(BR)CEO}$	Collector-Emitter Breakdown Voltage	30	-	-	V	$I_C = 1\text{ mA}$
$V_{(BR)ECO}$	Emitter-Collector Breakdown Voltage	5	-	-	V	$I_E = 100\text{ }\mu\text{A}$
$I_{CEO}$	Collector-Emitter Dark Current	-	-	100	nA	$V_{CE} = 10\text{ V}$

#### Combined

$V_{CE(SAT)}$	Collector-Emitter Saturation Voltage					
	Parameter A (OPB800,OPB810)	-	-	0.4	V	$I_C = 250\text{ }\mu\text{A}, I_F = 20\text{ mA}$
	Parameter B (OPB801,OPB811)	-	-	0.4	V	$I_C = 500\text{ }\mu\text{A}, I_F = 10\text{ mA}$
	Parameter C (OPB802,OPB812)	-	-	0.6	V	$I_C = 1800\text{ }\mu\text{A}, I_F = 20\text{ mA}$
$I_{C(ON)}$	On-State Collector Current					
	Parameter A (OPB800,OPB810)	0.625	-	-	mA	$V_{CE} = 10\text{ V}, I_F = 20\text{ mA}$
	Parameter B (OPB801,OPB811)	1.25	-	-		$V_{CE} = 5\text{ V}, I_F = 10\text{ mA}$
Parameter C (OPB802,OPB812)	2.25	-	-	$V_{CE} = 0.6\text{ V}, I_F = 20\text{ mA}$		

#### Notes:

- (1) Derate linearly 1.67 mW/ $^\circ\text{C}$  above 25  $^\circ\text{C}$ .
- (2) RMA flux is recommended. Duration can be extended to 10 seconds maximum when flow soldering.
- (3) All parameters tested using pulse technique.
- (4) Methanol or isopropanol are recommended as cleaning agents. Plastic housing is soluble in chlorinated hydrocarbons and ketones.
- (5) The W Series includes wire terminations of 24" (610 mm) 7-strand, 26 AWG UL insulated wire on each terminal. Each device incorporates a wire strain relief at the housing surface. The insulation functions and colors are: anode (red), cathode (black), phototransistor collector (white) and phototransistor emitter (green).

#### General Note

TT Electronics reserves the right to make changes in product specification without notice or liability. All information is subject to TT Electronics' own data and is considered accurate at time of going to print.

TT Electronics | OPTEK Technology  
1645 Wallace Drive, Carrollton, TX 75006 | Ph: +1 972 323 2200  
www.ttelectronics.com | sensors@ttelectronics.com

# Wide Gap Slotted Optical Switch

OPB800 (L and W Series)



## Performance

OPB800\_51 - Flag Next to Emitter

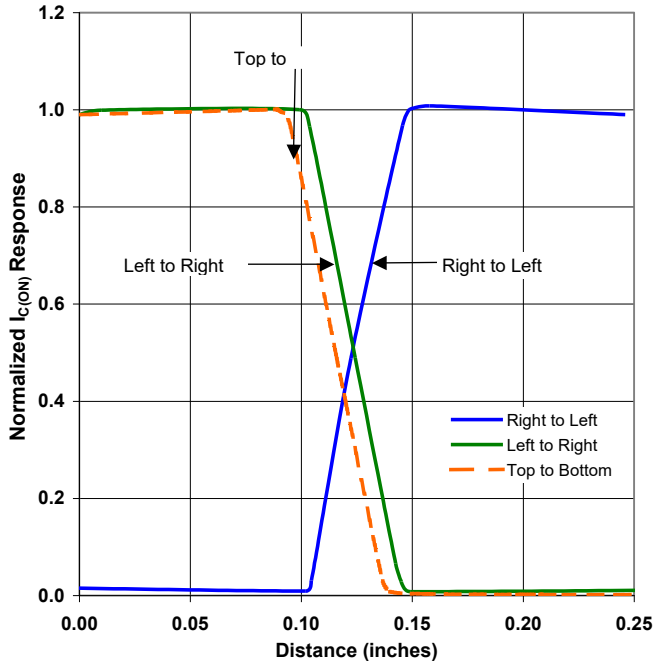

OPB800\_51 - Flag Next to Sensor

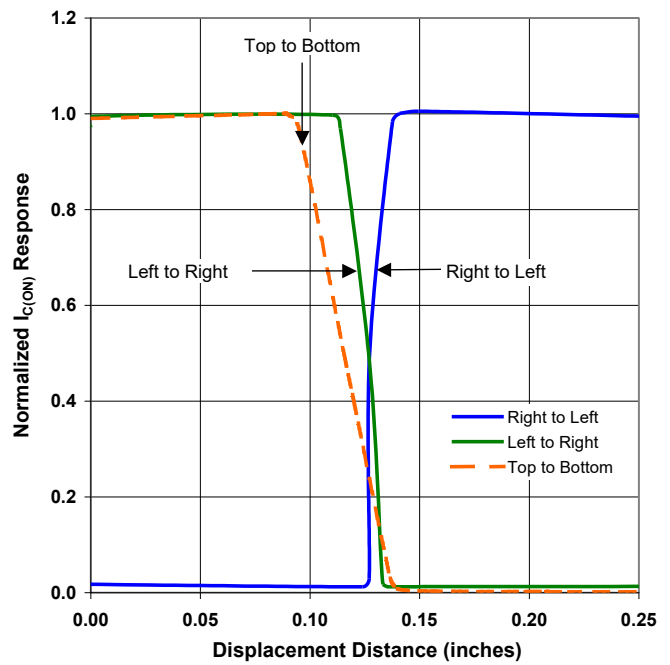

OPB800\_51 - Flag in Middle of Slot

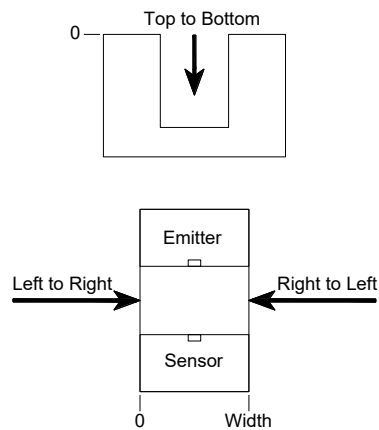
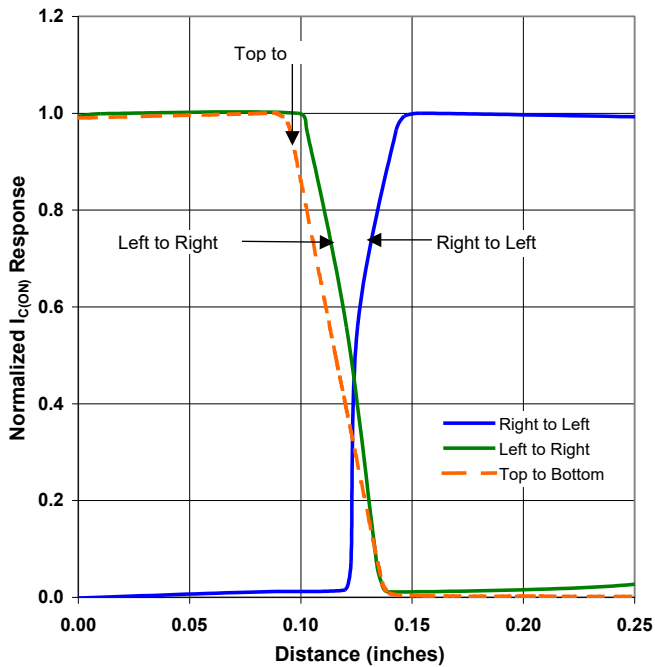

General Note

TT Electronics reserves the right to make changes in product specification without notice or liability. All information is subject to TT Electronics' own data and is considered accurate at time of going to print.

TT Electronics | OPTEK Technology  
 1645 Wallace Drive, Carrollton, TX 75006 | Ph: +1 972 323 2200  
[www.ttelectronics.com](http://www.ttelectronics.com) | [sensors@ttelectronics.com](mailto:sensors@ttelectronics.com)

# Wide Gap Slotted Optical Switch

OPB800 (L and W Series)



## Performance

OPB800\_55 - Flag Next to Emitter

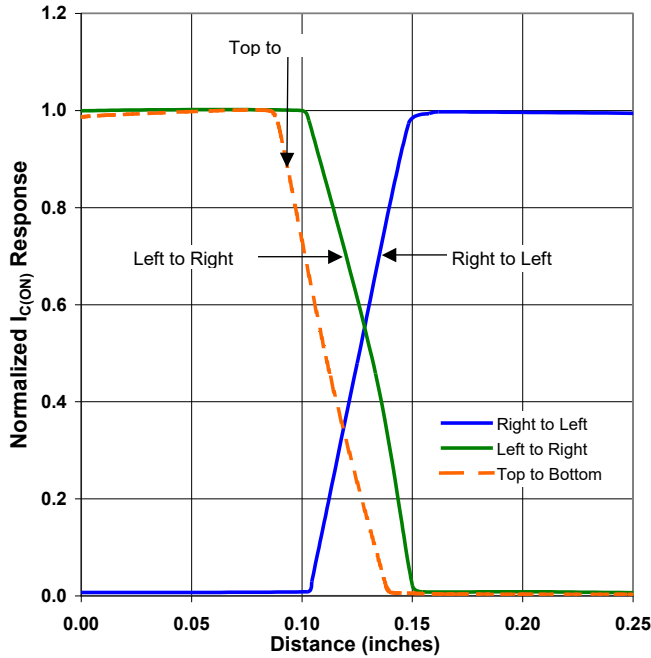

OPB800\_55 - Flag Next to Sensor

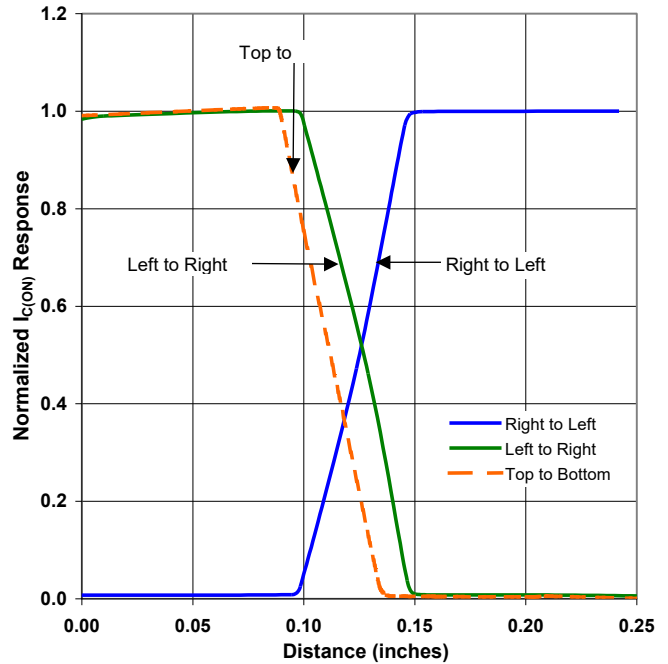

OPB800\_55 - Flag in Middle of Slot

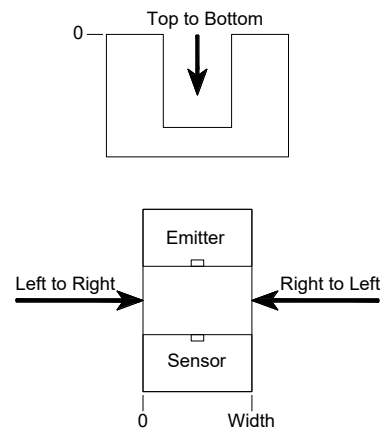
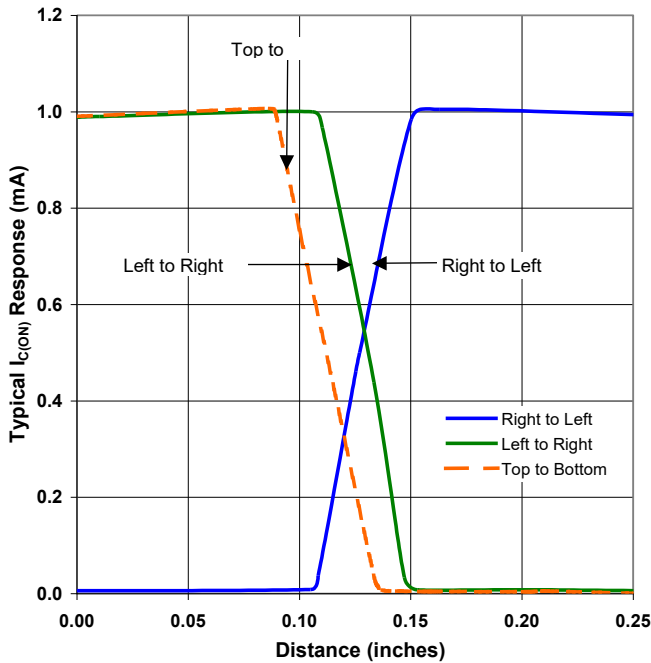

General Note

TT Electronics reserves the right to make changes in product specification without notice or liability. All information is subject to TT Electronics' own data and is considered accurate at time of going to print.

TT Electronics | OPTEK Technology  
1645 Wallace Drive, Carrollton, TX 75006 | Ph: +1 972 323 2200  
www.ttelectronics.com | sensors@ttelectronics.com

## X-ON Electronics

Largest Supplier of Electrical and Electronic Components

*Click to view similar products for* [Optical Switches, Transmissive, Phototransistor Output](#) *category:*

*Click to view products by* [TT Electronics](#) *manufacturer:*

Other Similar products are found below :

[LTH-301-07](#) [LTH-301-23](#) [E3C-X2C](#) [E3S-LS20B4S1](#) [E3SX2CE4](#) [RPI-2501](#) [RPI-576A](#) [KRA021](#) [LTH-306-04M](#) [LTH-309-08](#) [HOA0865-100](#) [HOA1961-055](#) [E3F-3C4](#) [LTH-306-01](#) [EESX677C1JR01M](#) [SIT506F-A](#) [HOA1883-501](#) [PT928-6B-F](#) [RPI-243](#) [EE-SX675P-WR 1M](#) [OPB806](#) [EE-SX1128](#) [OPB857Z](#) [EE-SV3-B](#) [EE-SJ3-D](#) [RPI-0226](#) [EE-SX954-W 1M](#) [EE-SX672R](#) [EE-SX670P-WR 1M](#) [EE-SX952P-W 1M](#) [LTH-301-32](#) [EESX674PWR1M](#) [EE-SX952-W 1M](#) [RPI-0352E](#) [SEN0448](#) [DY-ITR002](#) [DY-ITR1100](#) [DY-ITR9909-W2](#) [HOA0825-001](#) [HOA0825-003](#) [HOA0860-N51](#) [HOA0861-N55](#) [HOA0861-P55](#) [HOA0861-T55](#) [HOA0866-P55](#) [HOA0866-T55](#) [HOA0867-P55](#) [HOA0867-T55](#) [HOA0870-T51](#) [HOA0871-L55](#)