

Photologic® Hermetic Sensors

Types OPL810, OPL811, OPL812, OPL813 Series

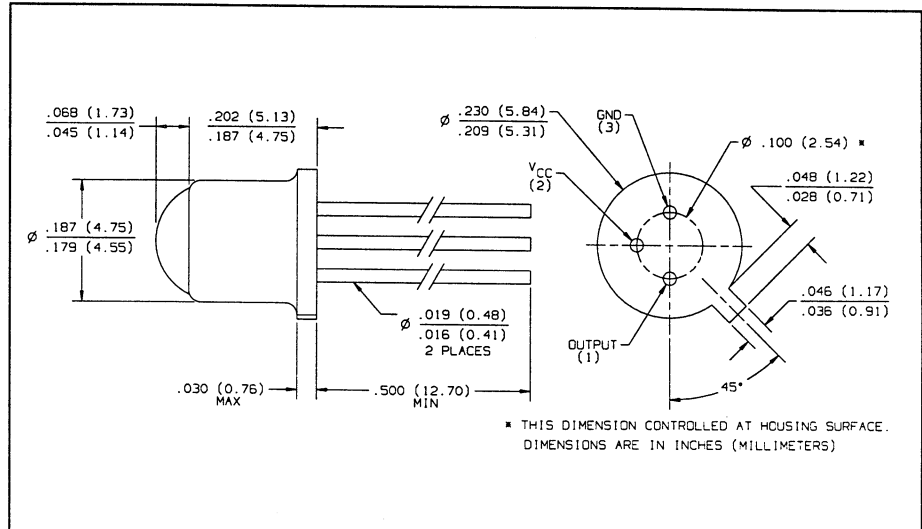
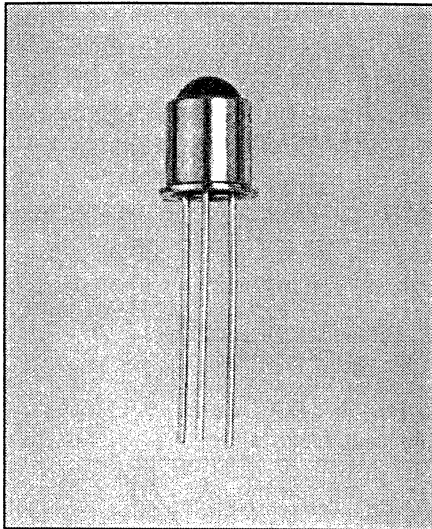

Features

- Four output options
- High noise immunity
- Direct TTL/LSTTL interface
- TO-18 hermetic package
- Mechanically and spectrally matched to the OP130 and OP230 series devices
- Two sensitivity options
- Data rate to 200 kBaud

Description

The OPL810, OPL810-OC, OPL811, OPL811-OC, OPL812, OPL812-OC, OPL813, and OPL813-OC contain a monolithic integrated circuit which incorporates a photodiode, a linear amplifier, a voltage regulator, and a Schmitt trigger on a single silicon chip. The devices feature TTL/LSTTL compatible logic level output which can drive up to 10 TTL loads over supply voltages ranging from 4.5V to 16V. The Schmitt trigger's hysteresis characteristics provide high immunity to noise on input and Vcc. The Photologic® chip is mounted on a standard TO-18 header which is hermetically sealed in a lensed metal can.

Absolute Maximum Ratings (TA = 25° C unless otherwise noted)

Supply Voltage, Vcc	18 V
Storage Temperature Range	-65° C to +125° C
Operating Temperature Range	-55° C to +105° C
Lead Soldering Temperature Range [1/16 inch (1.6 mm) from case for 5 sec. with soldering iron]	260° C ⁽¹⁾
Power Dissipation	250 mW ⁽²⁾
Duration of Output Short to Vcc (OPL810, OPL811, OPL812, OPL813)	1 sec.
Duration of Output Short to Vcc (OPL810-OC, OPL811-OC, OPL812-OC, OPL813-OC)	1 sec.
Voltage at Output Lead (OPL810-OC, OPL811-OC, OPL812-OC, OPL813-OC)	35 V
Sinking Current	50 mA
Sourcing Current (OPL810, OPL811, OPL812, OPL813)	10 mA
Irradiance (OPL810, OPL810-OC, OPL811, OPL811-OC)	2 mW/cm ²
Irradiance (OPL812, OPL812-OC, OPL813, OPL813-OC)	1 mW/cm ²

Notes:

- (1) RMA flux is recommended. Duration can be extended to 10 sec. max. when flow soldering. Max 20 grams force may be applied to the leads when soldering.
- (2) Derate linearly 2.5 mW/° C above 25° C.
- (3) Light measurements are made with λi = 935 nm.

Schematics

OPL810, OPL812

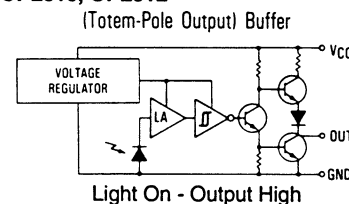

OPL811, OPL813

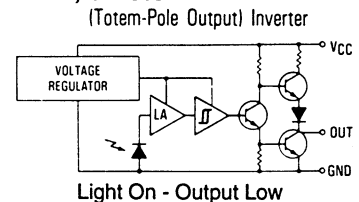

OPL810-OC, OPL812-OC

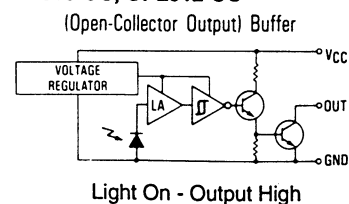

OPL811-OC, OPL813-OC

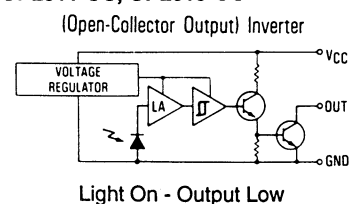

Types OPL810, OPL811 Series

Electrical Characteristics (-40° C to +100° C unless otherwise noted) $V_{CC} = 4.5 \text{ V to } 16 \text{ V}$

SYMBOL	PARAMETER	MIN	TYP	MAX	UNITS	TEST CONDITIONS
V_{CC}	Operating Supply Voltage	4.5		16.0	V	
	Peak-to-Peak V_{CC} Ripple Necessary to Cause False Triggering of Output			1.0	V	$f = \text{DC to } 50 \text{ MHz}$
$E_{eT(+)}$	Positive-Going Threshold Irradiance ⁽³⁾	0.015	0.06	0.20	mW/cm^2	$T_A = 25^\circ \text{ C}$
$E_{eT(+)} / E_{eT(-)}$	Hysteresis Ratio	1.20	1.55	2.00		
I_{CC}	Supply Current			15.0	mA	$E_e = 0 \text{ or } 0.4 \text{ mW/cm}^2$
OPL810 (Buffer, Totem-Pole)						
V_{OH}	High Level Output Voltage	$V_{CC}-2.1$			V	$I_{OH} = -1 \text{ mA}, E_e = 0.4 \text{ mW/cm}^2$
V_{OL}	Low Level Output Voltage			0.40	V	$I_{OL} = 16 \text{ mA}, E_e = 0$
OPL810-OC (Buffer, Open-Collector)						
I_{OH}	High Level Output Current			100	μA	$V_{OH} = 30 \text{ V}, E_e = 0.4 \text{ mW/cm}^2$
V_{OL}	Low Level Output Voltage			0.40	V	$I_{OL} = 16 \text{ mA}, E_e = 0$
OPL811 (Inverter, Totem-Pole)						
V_{OH}	High Level Output Voltage	$V_{CC}-2.1$			V	$I_{OH} = -1 \text{ mA}, E_e = 0$
V_{OL}	Low Level Output Voltage			0.40	V	$I_{OL} = 16 \text{ mA}, E_e = 0.4 \text{ mW/cm}^2$
OPL811-OC (Inverter, Open-Collector)						
I_{OH}	High Level Output Current			100	μA	$V_{OH} = 30 \text{ V}, E_e = 0$
V_{OL}	Low Level Output voltage			0.40	V	$I_{OL} = 16 \text{ mA}, E_e = 0.4 \text{ mW/cm}^2$
OPL810, OPL811						
t_r, t_f	Output Rise Time, Output Fall Time			70	ns	$V_{CC} = 5 \text{ V}, T_A = 25^\circ \text{ C}, E_e = 0 \text{ or } 0.4 \text{ mW/cm}^2, f = 10 \text{ kHz}$
t_{PLH}, t_{PHL}	Propagation Delay, Low-High, High-Low		5.0		μs	$\text{DC} = 50\%, R_L = 10 \text{ TTL Loads}$
OPL810-OC, OPL811-OC						
t_r, t_f	Output rise Time, Output Fall Time			100	ns	$V_{CC} = 5 \text{ V}, T_A = 25^\circ \text{ C}, E_e = 0 \text{ or } 0.4 \text{ mW/cm}^2, f = 10 \text{ kHz}$
t_{PLH}, t_{PHL}	Propagation Delay, Low-High, High-Low		5.0		μs	$\text{DC} = 50\%, R_L = 300 \Omega$

PHOTOLGIC
SENSORS

Typical Performance Curves

Output Voltage vs. Ambient Temp.

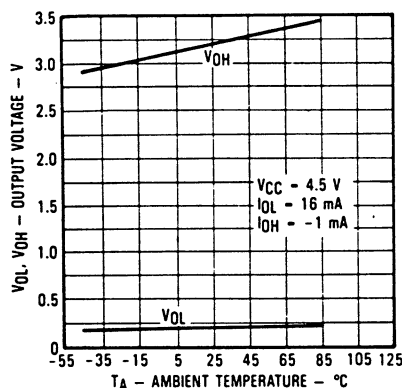

High Output Current vs. Ambient Temp.

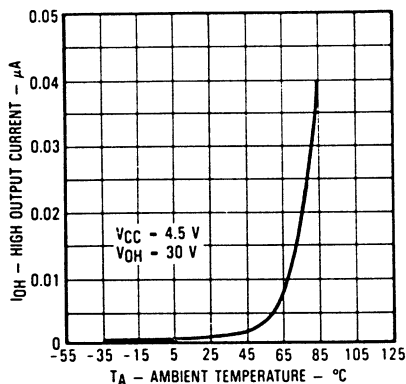

Normalized Threshold Irradiance vs. T_A

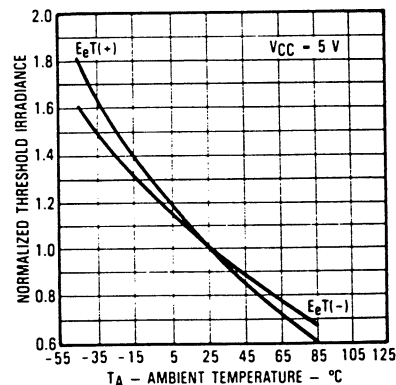

Optek reserves the right to make changes at any time in order to improve design and to supply the best product possible.

Optek Technology, Inc. 1215 W. Crosby Road Carrollton, Texas 75006 (972)323-2200 Fax (972)323-2396

Types OPL812, OPL813 Series



Electrical Characteristics (-40° C to +100° C unless otherwise noted) $V_{CC} = 4.5 \text{ V to } 16 \text{ V}$

SYMBOL	PARAMETER	MIN	TYP	MAX	UNITS	TEST CONDITIONS
V_{CC}	Operating Supply Voltage	4.5		16.0	V	
	Peak-to-Peak V_{CC} Ripple Necessary to Cause False Triggering of Output			1.0	V	$f = \text{DC to } 50 \text{ MHz}$
$E_{eT(+)}$	Positive-Going Threshold Irradiance ⁽³⁾	0.005	0.025	0.10	mW/cm^2	$T_A = 25^\circ \text{ C}$
$E_{eT(+)} / E_{eT(-)}$	Hysteresis Ratio	1.20	1.55	2.00		
I_{CC}	Supply Current			15.0	mA	$E_e = 0 \text{ or } 0.2 \text{ mW/cm}^2$
OPL812 (Buffer, Totem-Pole)						
V_{OH}	High Level Output Voltage	$V_{CC}-2.1$			V	$I_{OH} = -1 \text{ mA}, E_e = 0.2 \text{ mW/cm}^2$
V_{OL}	Low Level Output Voltage			0.40	V	$I_{OL} = 16 \text{ mA}, E_e = 0$
OPL812-OC (Buffer, Open-Collector)						
I_{OH}	High Level Output Current			100	μA	$V_{OH} = 30 \text{ V}, E_e = 0.2 \text{ mW/cm}^2$
V_{OL}	Low Level Output Voltage			0.40	V	$I_{OL} = 16 \text{ mA}, E_e = 0$
OPL813 (Inverter, Totem-Pole)						
V_{OH}	High Level Output Voltage	$V_{CC}-2.1$			V	$I_{OH} = -1 \text{ mA}, E_e = 0$
V_{OL}	Low Level Output Voltage			0.40	V	$I_{OL} = 16 \text{ mA}, E_e = 0.2 \text{ mW/cm}^2$
OPL813-OC (Inverter, Open-Collector)						
I_{OH}	High Level Output Current			100	μA	$V_{OH} = 30 \text{ V}, E_e = 0$
V_{OL}	Low Level Output Voltage			0.40	V	$I_{OL} = 16 \text{ mA}, E_e = 0.2 \text{ mW/cm}^2$
OPL812, OPL813						
t_r, t_f	Output Rise Time, Output Fall Time			70	ns	$V_{CC} = 5 \text{ V}, T_A = 25^\circ \text{ C}, E_e = 0 \text{ or } 0.2 \text{ mW/cm}^2, f = 10 \text{ kHz}$
t_{PLH}, t_{PHL}	Propagation Delay, Low-High, High-Low		5.0		μs	DC = 50%, $R_L = 10 \text{ TTL Loads}$
OPL812-OC, OPL813-OC						
t_r, t_f	Output Rise Time, Output Fall Time			100	ns	$V_{CC} = 5 \text{ V}, T_A = 25^\circ \text{ C}, E_e = 0 \text{ or } 0.2 \text{ mW/cm}^2, f = 10 \text{ kHz}$
t_{PLH}, t_{PHL}	Propagation Delay, Low-High, High-Low		5.0		μs	DC = 50%, $R_L = 300 \Omega$

Typical Performance Curves

Normalized Threshold Irradiance vs. Amb. Temp.

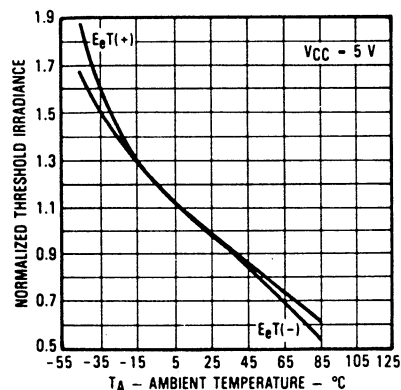

Normalized Spectral Response

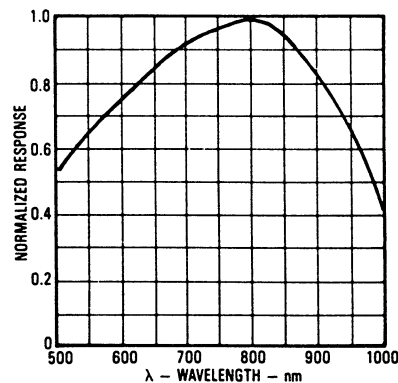

Angular Displacement from Package Mechanical Axis

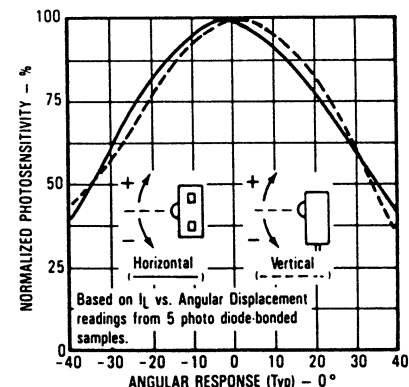

Types OPL812, OPL813 Series

Typical Performance Curves

Normalized Supply Current vs. Ambient Temperature

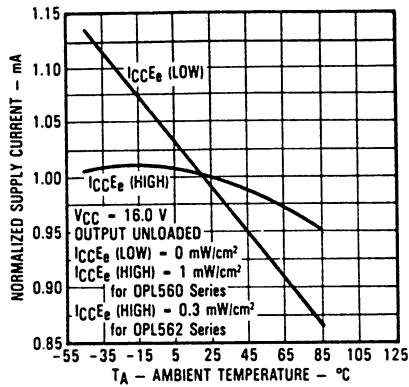

Propagation Time vs. Amb. Temp.

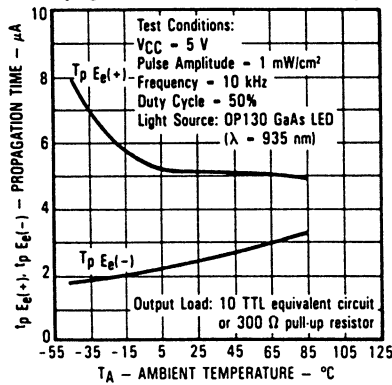

Propagation Time vs. Amb. Temp.

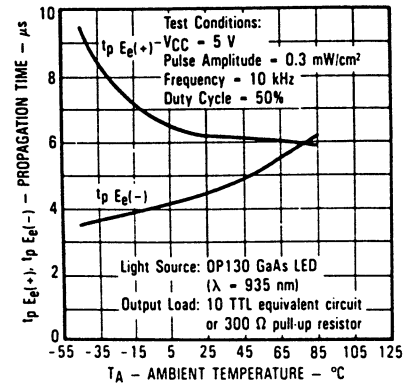

Rise Time & Fall Time vs. TA

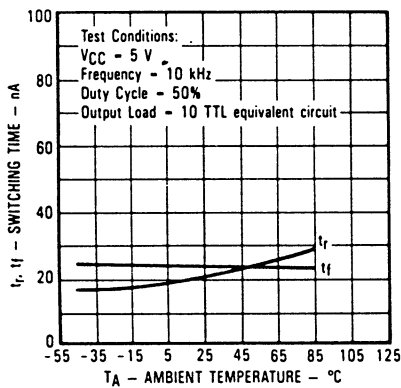

Rise Time & Fall Time vs. TA vs. Output Load

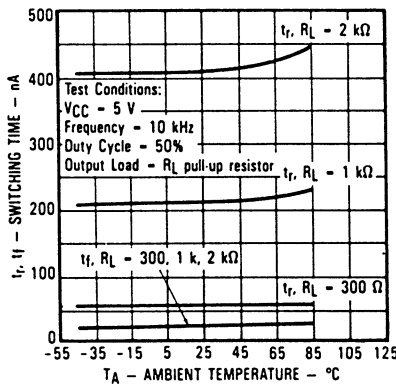

Switching Test Curves

Switching Test Curve for Inverters

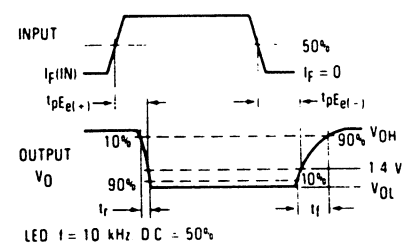

Switching Test Curve for Buffers

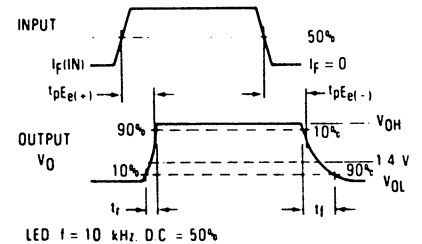

PHOTOLOGIC®
SENSORS

Optek reserves the right to make changes at any time in order to improve design and to supply the best product possible.

Optek Technology, Inc.

1215 W. Crosby Road

Carrollton, Texas 75006

(972)323-2200

Fax (972)323-2396

X-ON Electronics

Largest Supplier of Electrical and Electronic Components

Click to view similar products for [Photo IC Sensors](#) category:

Click to view products by [TT Electronics](#) manufacturer:

Other Similar products are found below :

[OPL800](#) [OPL810](#) [OPL811-OC](#) [OPL820](#) [ADPD2210ACPZ-R7](#) [OPL801](#) [OPL813-OC](#) [OPL820-OC](#) [ADPD2214ACPZ-R7](#) [HOA6299-003](#)
[SD5610-001](#) [SD5630-001](#) [SD5630-002](#) [SDP8600-003](#) [SDP8601-002](#) [SDP8610-003](#) [SDP8611-002](#) [SDP8611-003](#) [QSE159](#) [QSE259](#)
[BU27006MUC-ZTR](#) [OPL821](#) [OPL530-OC](#) [OPL531-OCA](#) [OPL550-OCA](#) [OPL562](#) [OPL562-OC](#) [OPL563-OC](#) [OP538F-001](#) [OP600-012](#)
[VEML3328SL](#) [VEML6040A3OG](#) [OPL801-OC](#) [OPL560](#) [SDP8614-301](#) [LTDL-TA16A](#) [OPL551](#)