

Miniature Surface Mount LED—OPR5200 Phototransistor—OPR5500

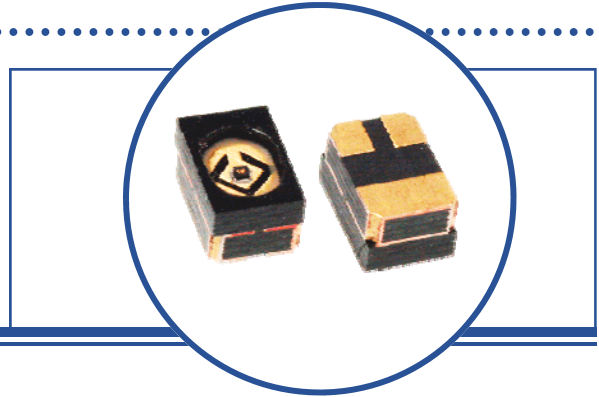

Features:

- Stackable on 2 mm centers
- Vertical or horizontal mounting
- Automatic pick-and-place compatible
- Combine OPR5200 and OPR5500 to create miniature switch



Description:

The **OPR5200** is a miniature high efficiency GaAlAs light emitting diode in a high temperature polyamide chip carrier that is well suited to space-limited applications which require close channel spacing.

The **OPR5500** is a miniature NPN silicon phototransistor housed in a high temperature polyamide chip carrier that is well suited to space-limited applications which require close channel spacing.

When combining the OPR5200 and OPR5500 (miniature phototransistor), this lateral mounting option can be used to create a non-focused reflective or slotted switch configuration.

These parts can be automatically placed with standard SMD equipment and can be reflow soldered by virtually any conventional means. Wraparound contacts allow it to be mounted face up or on edge for a beam direction parallel to the seating plane.

See Application Bulletin 237 for handling instructions

Applications:

- Slotted switches
- Industrial environments
- Space-limited applications

Ordering Information						
Part Number	LED Peak Wavelength	Output Power (μW) Min	I _F (mA) Typ / Max	Total Beam Angle (Degrees)	Rise / Fall Times (nS) Typ	Packaging
OPR5200	890 nm	350	20 / 50	90	500 / 250	Chip Tray
Part Number	Sensor	Light Current I _{C(ON)} (μA) Min	V _{CE} Max	Input Power E _E (μW/cm ²)	Viewing Angle (Degrees)	Packaging
OPR5500	Transistor	36	30	150	120	Chip Tray

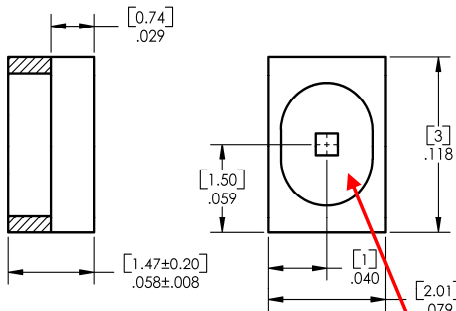
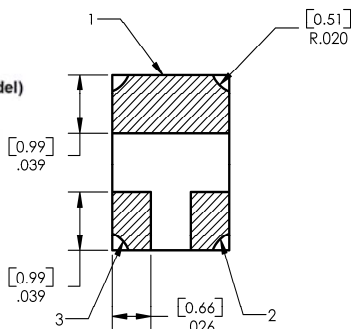

OPR5200		OPR5500	
Pin #	LED	Pin #	Transistor
1	Anode	1	Collector
2	Cathode	2	Emitter
3	N.C.	3	Base

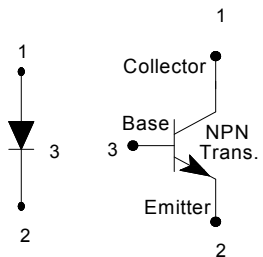

Warning: Front Window is pressure sensitive. Do not apply pressure or high vacuum to window.

TOLERANCE IS ± .005 [0.13]

DIMENSIONS ARE IN: [MILLIMETERS] INCHES



RoHS

OPTEK reserves the right to make changes at any time in order to improve design and to supply the best product possible.

Miniature Surface Mount LED—OPR5200 Phototransistor—OPR5500



OPR5200 Absolute Maximum Ratings ($T_A = 25^\circ\text{C}$ unless otherwise noted)

Storage and Operating Temperature	-55° C to +125° C
Continuous Forward Current	50 mA
Peak Forward Current (1 μs pulse width, 10% duty cycle)	1.0 A
Power Dissipation ⁽¹⁾	100 mW
Solder reflow time within 5° C of peak temperature is 20 to 40 seconds ⁽²⁾	250° C

OPR5200 Electrical Characteristics ($T_A = 25^\circ\text{C}$ unless otherwise noted)

SYMBOL	PARAMETER	MIN	TYP	MAX	UNITS	TEST CONDITIONS
P_O	Output Power	350	-	-	μW	$I_F = 20\text{ mA}$
V_F	Forward Voltage	-	-	1.8	V	$I_F = 20\text{ mA}$
I_R	Reverse Current	-	-	100	μA	$V_R = 2\text{ V}$
λ_P	Peak Wavelength	-	890	-	nm	$I_F = 20\text{ mA}$
λ_{BW}	Spectral Bandwidth	-	80	-	nm	$I_F = 20\text{ mA}$
θ_{HP}	Emission Angle	-	$\pm 45^\circ$	-	-	at half power points
t_r	Output Rise Time	-	500	-	ns	$I_P = 100\text{ mA}$, $PW = 10.0\ \mu\text{s}$, D.C. = 10%
t_f	Output Fall Time	-	250	-	ns	

Notes:

- (1) Derate at 1.00 mW/° C above 25° C.
- (2) Solder time less than 5 seconds at temperature extreme.

Forward Voltage vs Forward Current vs Temperature

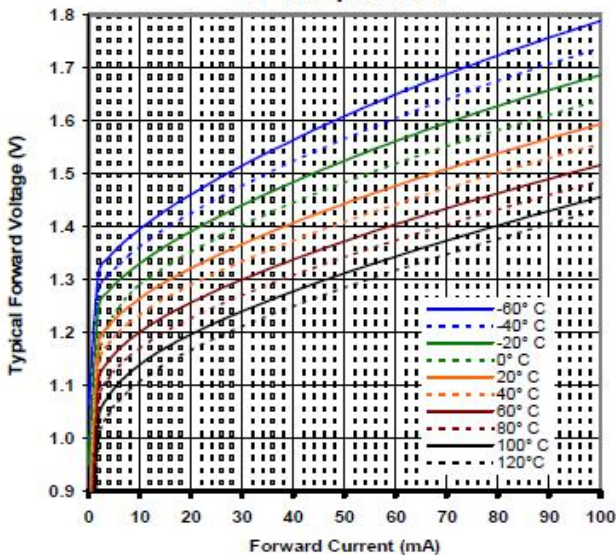

Optical Power vs I_F vs Temperature

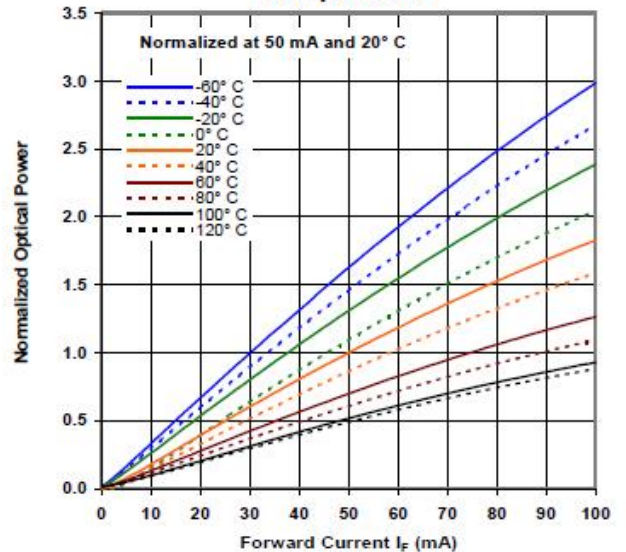

OPTEK reserves the right to make changes at any time in order to improve design and to supply the best product possible.

**Miniature Surface Mount
LED—OPR5200
Phototransistor—OPR5500**



OPR5500 Absolute Maximum Ratings ($T_A = 25^\circ\text{C}$ unless otherwise noted)

Storage and Operating Temperature	-55° C to +125° C
Collector-Emitter Voltage	30 V
Emitter-Collector Voltage	5 V
Power Dissipation ⁽¹⁾	100 mW
Solder reflow time within 5°C of peak temperature is 20 to 40 seconds ⁽²⁾	250° C

OPR5500 Electrical Characteristics ($T_A = 25^\circ\text{C}$ unless otherwise noted)

SYMBOL	PARAMETER	MIN	TYP	MAX	UNITS	TEST CONDITIONS
$I_{C(ON)}$	On-State Collector Current	36	-	-	μA	$V_{CE} = 5\text{ V}$, $E_e = 150\ \mu\text{W}/\text{cm}^2$ (890 nm light source)
I_{CEO}	Dark Current	-	-	100	nA	$V_{CE} = 5\text{ V}$, $E_e = 0$
$V_{(BR)CEO}$	Collector-Emitter Breakdown Voltage	30	-	-	V	$I_C = 100\ \mu\text{A}$
$V_{(BR)ECO}$	Emitter-Collector Breakdown Voltage	5	-	-	V	$I_E = 100\ \mu\text{A}$
$V_{(SAT)}$	Saturation Voltage	-	-	0.4	V	$I_C = 100\ \mu\text{A}$, $E_e = 5\ \text{mW}/\text{cm}^2$
t_r, t_f	Output Rise and Fall Time	-	2.5	-	μs	$V_{CC} = 5\text{ V}$, $I_C = 800\ \mu\text{A}$, $R_L = 100\ \Omega$

Notes:

- (1) Derate at 1.00 mW/° C above 25° C.
- (2) Solder time less than 5 seconds at temperature extreme.

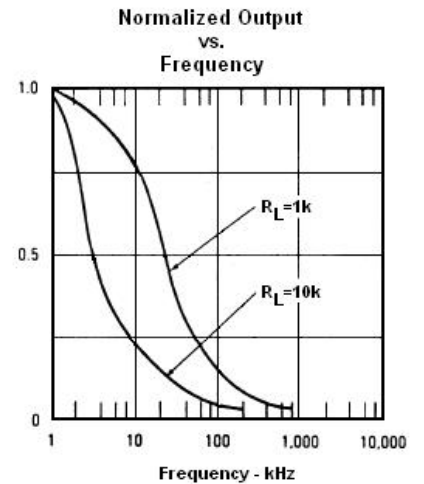
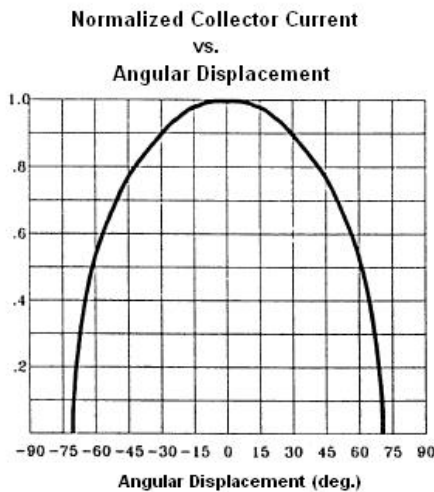
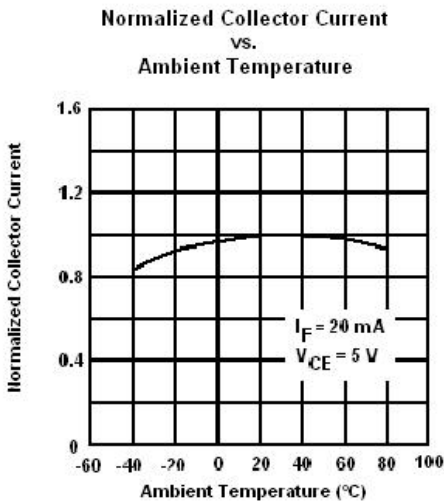

OPTEK reserves the right to make changes at any time in order to improve design and to supply the best product possible.

X-ON Electronics

Largest Supplier of Electrical and Electronic Components

Click to view similar products for [Phototransistors](#) category:

Click to view products by [TT Electronics](#) manufacturer:

Other Similar products are found below :

[LTR-5576D](#) [PT17-21B/L41/TR8](#) [PT908-7B-F](#) [ASDL-6620-C22](#) [OED-ST-8LR2](#) [OED-STR44B90-TR](#) [SD5410-109](#) [PT26-21C/CT](#) [PT15-21B-TR8](#) [PT-IC-AC-3528-520](#) [PT-IC-BC-3528-550](#) [MHT153PTBT](#) [MHS153PTBT](#) [PT5529B/L2/H2-F](#) [PT91-21C/TR10](#) [BP 103-3/4](#) [BPX 38-3](#) [BPY 62](#) [KPS-3227SP1C](#) [L-53P3BT](#) [L-53P3C](#) [L-93DP3BT](#) [L-93DP3C](#) [LL-503PTC2E-1AD](#) [LL-S150PTC-1A](#) [LL-S150PTD-1A](#) [SFH 320](#) [SFH 320-3](#) [SFH 320 FA](#) [OP508FA](#) [TEMT1030](#) [LTR-301](#) [PGM5516-MP](#) [PGM5526-MP](#) [PGM5549](#) [PGM5637D](#) [VTT7125H](#) [VEMT4700F-GS08](#) [PT19-21B/L41/TR8](#) [KP-2012P3C](#) [TEKT5400S](#) [SD1410-128L](#) [SFH 313 FA-3/4](#) [SFH 313 FA-2/3](#) [SFH 320-4-Z](#) [SFH 309 FA-5/6](#) [PT4800FE000F](#) [SFH 309-5/6](#) [SFH 3410-1/2-Z](#) [SFH 3410R](#)