

TF2301 P-Channel 20-V(D-S) MOSFET

$V_{(BR)DSS}$	$R_{DS(on)MAX}$	I_D
-20V	0.100Ω@-4.5V	-2.8A
	0.130 Ω@-2.5V	

General FEATURE

- TrenchFET Power MOSFET
- Lead free product is acquired
- Surface mount package

APPLICATION

- Load Switch for Portable Devices
- DC/DC Converter

SOT-23

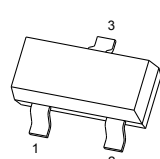

1.GATE
2.SOURCE
3.DRAIN

MARKING



A15HB w

*w: week code

Equivalent Circuit

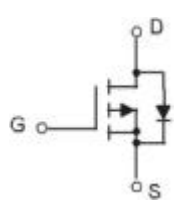

Maximum ratings ($T_a=25^{\circ}C$ unless otherwise noted)

Parameter	Symbol	Value	Unit
Drain-Source Voltage	V_{DS}	-20	V
Gate-Source Voltage	V_{GS}	±12	
Continuous Drain Current	I_D	-2.8	A
Pulsed Drain Current	I_{DM}	-10	
Continuous Source-Drain Diode Current	I_S	-1.30	
Maximum Power Dissipation	P_D	1.0	W
Thermal Resistance from Junction to Ambient($t \leq 5s$)	$R_{\theta JA}$	178	$^{\circ}C/W$
Junction Temperature	T_J	150	$^{\circ}C$
Storage Temperature	T_{stg}	-55 ~+150	



SOT-23 Plastic-Encapsulate MOSFETS

TF2301

MOSFET ELECTRICAL CHARACTERISTICS

T_a =25 °C unless otherwise specified

Parameter	Symbol	Test Condition	Min	Typ	Max	Units
Static						
Drain-source breakdown voltage	V _{(BR)DSS}	V _{GS} = 0V, I _D = -250μA	-20			V
Gate-source threshold voltage	V _{GS(th)}	V _{DS} = V _{GS} , I _D = -250μA	-0.5	-0.7	-1	
Gate-source leakage	I _{GSS}	V _{DS} = 0V, V _{GS} = ±10V			±100	nA
Zero gate voltage drain current	I _{DSS}	V _{DS} = -20V, V _{GS} = 0V			-1	μA
Drain-source on-state resistance ^a	R _{DS(on)}	V _{GS} = -4.5V, I _D = -2.8A		0.090	0.100	Ω
		V _{GS} = -2.5V, I _D = -2.0A		0.110	0.130	
Forward transconductance ^a	g _{fs}	V _{DS} = -5V, I _D = -2.0A	4.0	6.5		S
Dynamic^b						
Input capacitance	C _{iss}	V _{DS} = -10V, V _{GS} = 0V, f = 1MHz		285		pF
Output capacitance	C _{oss}			58		
Reverse transfer capacitance	C _{rss}			32		
Total gate charge	Q _g	V _{DS} = -10V, V _{GS} = -4.5V, I _D = -3A		5.5	10	nC
		V _{DS} = -10V, V _{GS} = -2.5V, I _D = -2A		2.9	6	
Gate-source charge	Q _{gs}			0.45		
Gate-drain charge	Q _{gd}			0.75		
Gate resistance	R _g	f = 1MHz		6.0		Ω
Turn-on delay time	t _{d(on)}	V _{DD} = -10V, R _L = 5Ω, I _D = -1A, V _{GEN} = -4.5V, R _g = 3Ω		9.8	20	ns
Rise time	t _r			4.9	60	
Turn-off delay time	t _{d(off)}			20.5	50	
Fall time	t _f			7.0	20	
Drain-source body diode characteristics						
Continuous source-drain diode current	I _S	T _C = 25°C			-1.3	A
Pulse diode forward current ^a	I _{SM}				-10	
Body diode voltage	V _{SD}	I _S = -1.0A		-0.8	-1.2	V

Notes :

a. Pulse Test : Pulse Width < 300μs, Duty Cycle ≤2%.

b. Guaranteed by design not subject to production testing.

Typical Electrical and Thermal Characteristics

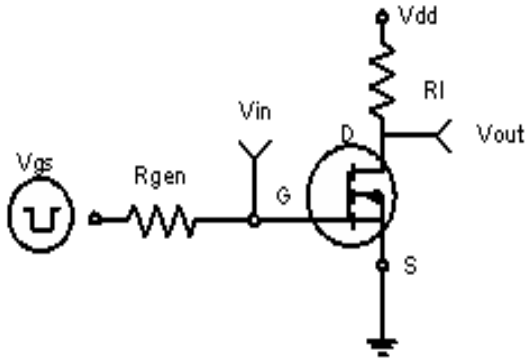

Figure 1: Switching Test Circuit

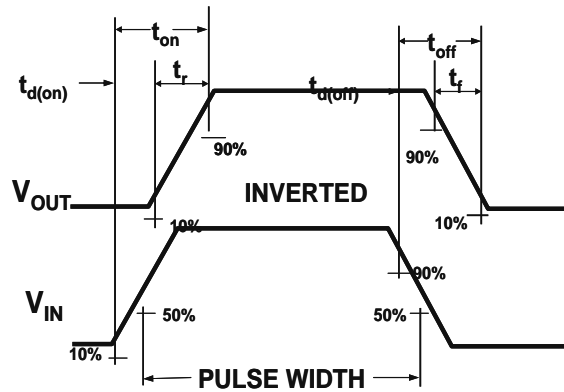

Figure 2: Switching Waveforms

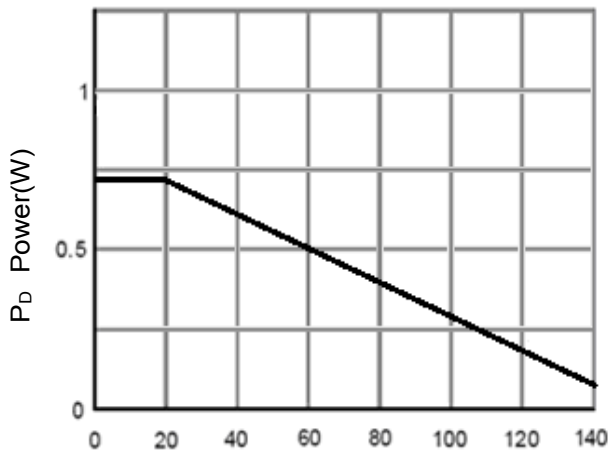

Figure 3 Power Dissipation

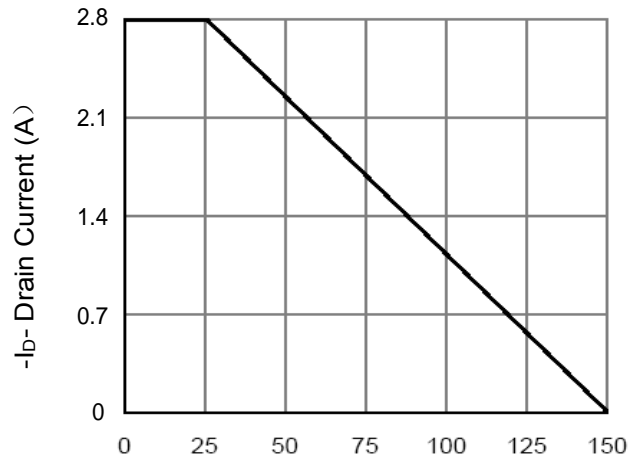

Figure 4 Drain Current

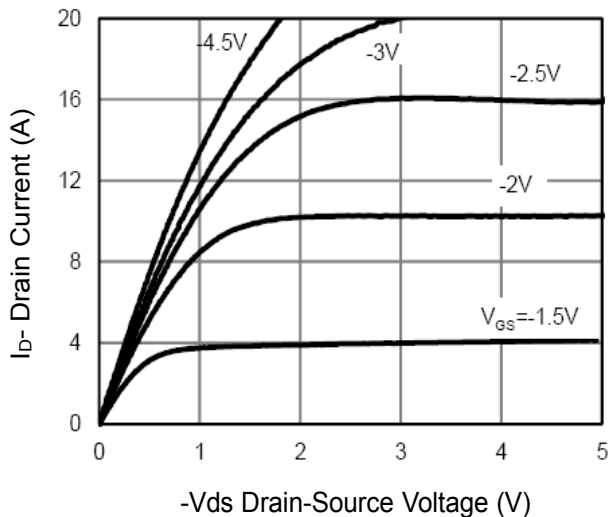

Figure 5 Output Characteristics

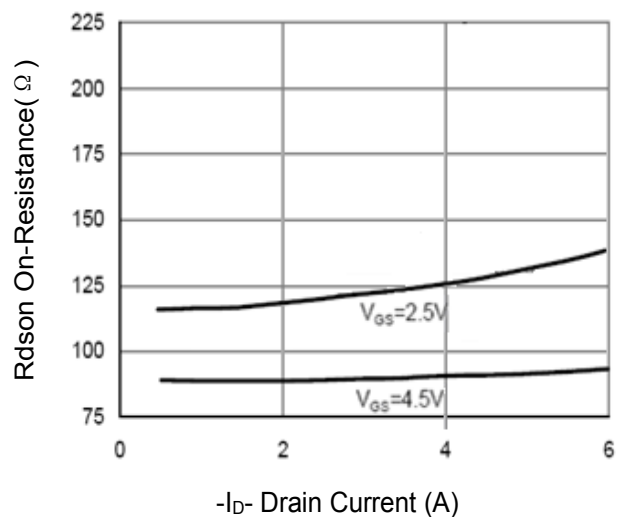

Figure 6 Drain-Source On-Resistance

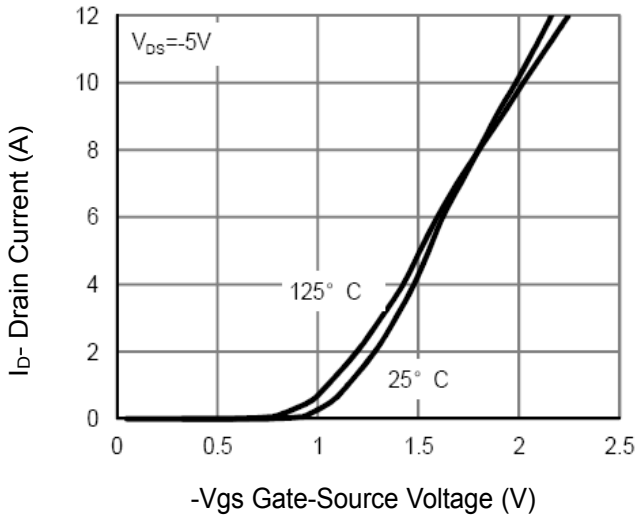

Figure 7 Transfer Characteristics

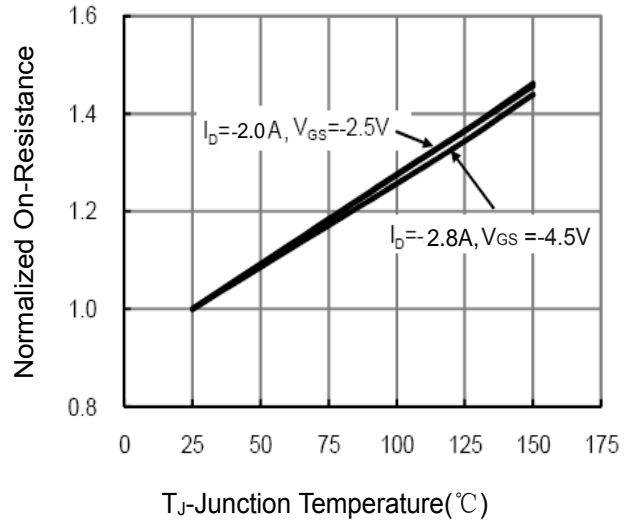

Figure 8 Drain-Source On-Resistance

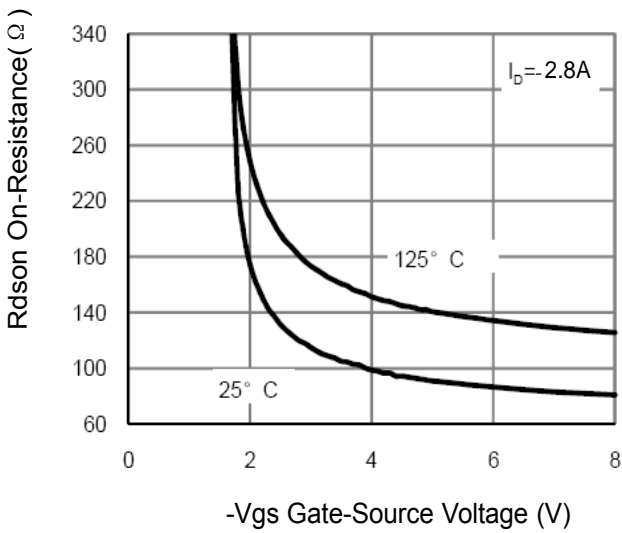

Figure 9 Rds(on) vs Vgs

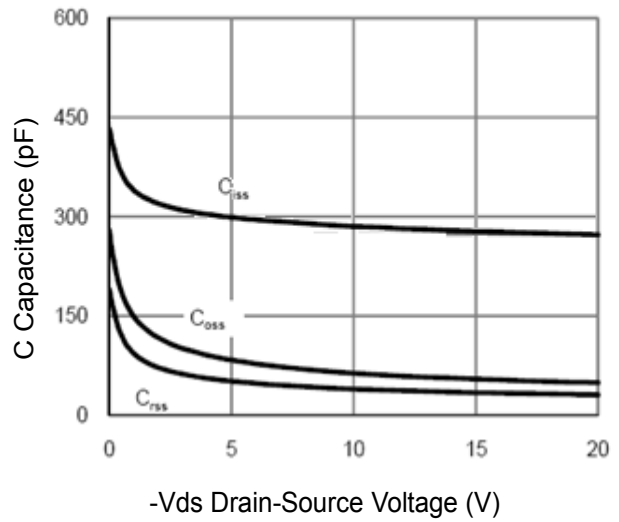

Figure 10 Capacitance vs Vds

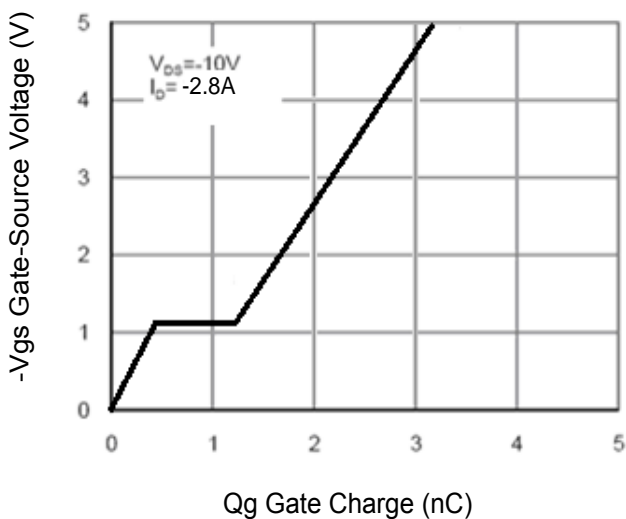

Figure 11 Gate Charge

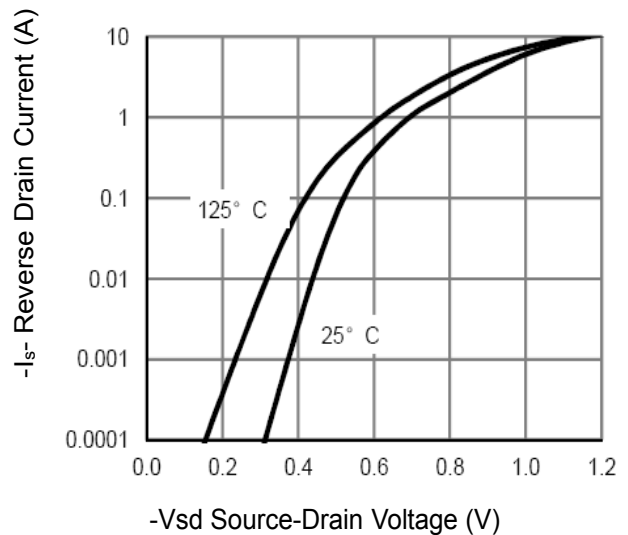

Figure 12 Source- Drain Diode Forward

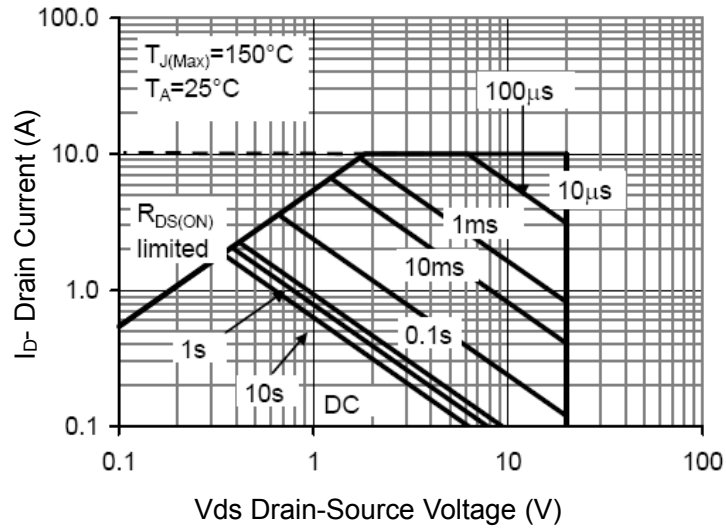

Figure 13 Safe Operation Area

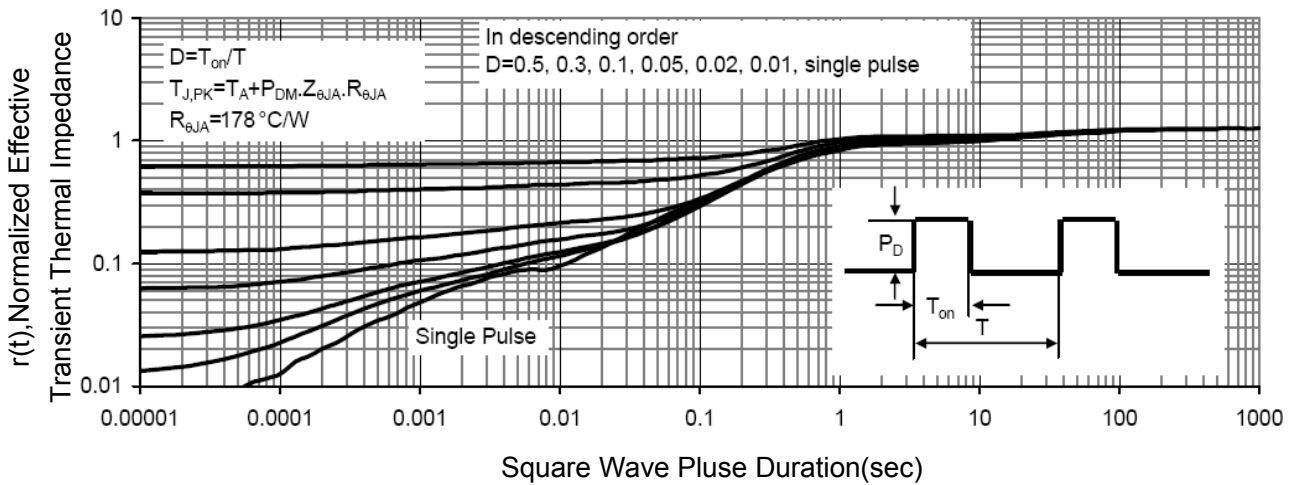
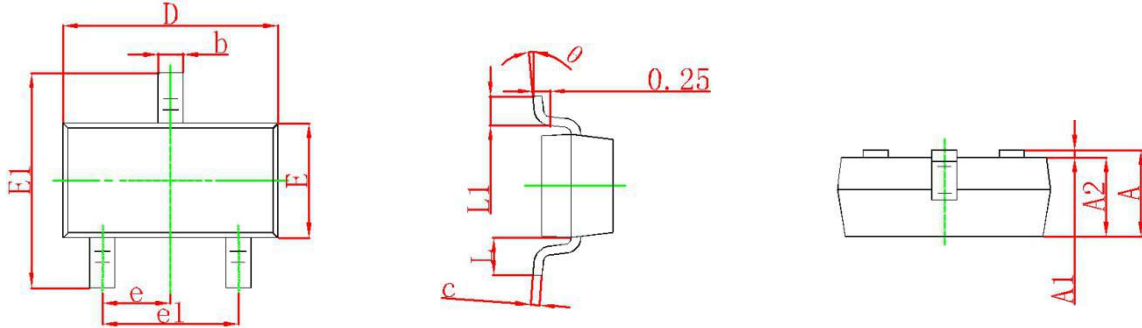

Figure 14 Normalized Maximum Transient Thermal Impedance

SOT-23 Package Outline Dimensions



Symbol	Dimensions In Millimeters		Dimensions In Inches	
	Min	Max	Min	Max
A	0.900	1.150	0.035	0.045
A1	0.000	0.100	0.000	0.004
A2	0.900	1.050	0.035	0.041
b	0.300	0.500	0.012	0.020
c	0.080	0.150	0.003	0.006
D	2.800	3.000	0.110	0.118
E	1.200	1.400	0.047	0.055
E1	2.250	2.550	0.089	0.100
e	0.950 TYP		0.037 TYP	
e1	1.800	2.000	0.071	0.079
L	0.550 REF		0.022 REF	
L1	0.300	0.500	0.012	0.020
θ	0°	8°	0°	8°

SOT-23 Suggested Pad Layout

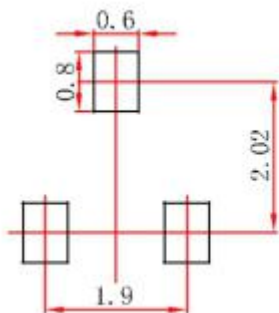

Note:
 1. Controlling dimension: in millimeters.
 2. General tolerance: $\pm 0.05\text{mm}$.
 3. The pad layout is for reference purposes only.

X-ON Electronics

Largest Supplier of Electrical and Electronic Components

Click to view similar products for [MOSFET](#) category:

Click to view products by [TuoFeng](#) manufacturer:

Other Similar products are found below :

[614233C](#) [648584F](#) [MCH3443-TL-E](#) [MCH6422-TL-E](#) [FDPF9N50NZ](#) [FW216A-TL-2W](#) [FW231A-TL-E](#) [APT5010JVR](#) [NTNS3A92PZT5G](#)
[IRF100S201](#) [JANTX2N5237](#) [2SK2464-TL-E](#) [2SK3818-DL-E](#) [FCA20N60_F109](#) [FDZ595PZ](#) [STD6600NT4G](#) [FSS804-TL-E](#) [2SJ277-DL-E](#)
[2SK1691-DL-E](#) [2SK2545\(Q,T\)](#) [D2294UK](#) [405094E](#) [423220D](#) [MCH6646-TL-E](#) [TPCC8103,L1Q\(CM](#) [367-8430-0972-503](#) [VN1206L](#)
[424134F](#) [026935X](#) [051075F](#) [SBVS138LT1G](#) [614234A](#) [715780A](#) [NTNS3166NZT5G](#) [751625C](#) [873612G](#) [IRF7380TRHR](#)
[IPS70R2K0CEAKMA1](#) [RJK60S3DPP-E0#T2](#) [RJK60S5DPK-M0#T0](#) [APT5010JVFR](#) [APT12031JFLL](#) [APT12040JVR](#) [DMN3404LQ-7](#)
[NTE6400](#) [JANTX2N6796U](#) [JANTX2N6784U](#) [JANTXV2N5416U4](#) [SQM110N05-06L-GE3](#) [SIHF35N60E-GE3](#)