

# SOT-23 Plastic-Encapsulate MOSFETS

TF3423

## TF3423 P-Channel 20-V(D-S) MOSFET

$V_{(BR)DSS}$	$R_{DS(on)MAX}$	$I_D$
-20V	0.100Ω@-4.5V	-2.0A
	0.130 Ω@-2.5V	

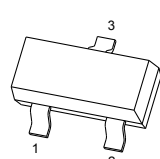
### General FEATURE

- TrenchFET Power MOSFET
- Lead free product is acquired
- Surface mount package

### APPLICATION

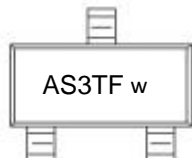
- Load Switch for Portable Devices
- DC/DC Converter

**SOT-23**



1.GATE  
2.SOURCE  
3.DRAIN

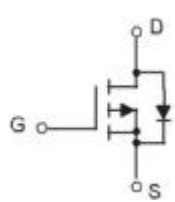
**MARKING**



AS3TF w

\*w: week code

**Equivalent Circuit**



### Maximum ratings ( $T_a=25^{\circ}C$ unless otherwise noted)

Parameter	Symbol	Value	Unit
Drain-Source Voltage	$V_{DS}$	-20	V
Gate-Source Voltage	$V_{GS}$	±12	
Continuous Drain Current	$I_D$	-2.0	A
Pulsed Drain Current	$I_{DM}$	-10	
Continuous Source-Drain Diode Current	$I_S$	-1.30	
Maximum Power Dissipation	$P_D$	1.0	W
Thermal Resistance from Junction to Ambient( $t \leq 5s$ )	$R_{\theta JA}$	178	$^{\circ}C/W$
Junction Temperature	$T_J$	150	$^{\circ}C$
Storage Temperature	$T_{stg}$	-55 ~+150	



**SOT-23 Plastic-Encapsulate MOSFETS**

**TF3423**

**MOSFET ELECTRICAL CHARACTERISTICS**

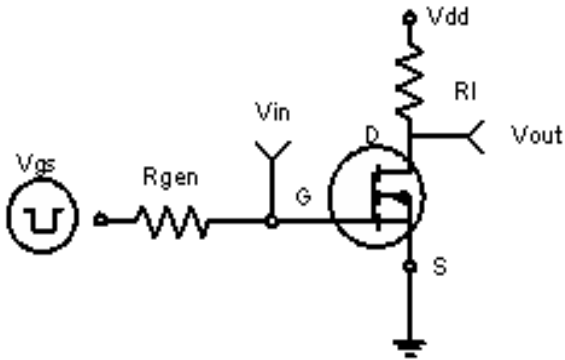
T<sub>a</sub> =25 °C unless otherwise specified

Parameter	Symbol	Test Condition	Min	Typ	Max	Units
<b>Static</b>						
Drain-source breakdown voltage	V <sub>(BR)DSS</sub>	V <sub>GS</sub> = 0V, I <sub>D</sub> =-250μA	-20			V
Gate-source threshold voltage	V <sub>GS(th)</sub>	V <sub>DS</sub> =V <sub>GS</sub> , I <sub>D</sub> =-250μA	-0.5	-0.7	-1	
Gate-source leakage	I <sub>GSS</sub>	V <sub>DS</sub> =0V, V <sub>GS</sub> =±10V			±100	nA
Zero gate voltage drain current	I <sub>DSS</sub>	V <sub>DS</sub> =-20V, V <sub>GS</sub> =0V			-1	μA
Drain-source on-state resistance <sup>a</sup>	R <sub>Ds(on)</sub>	V <sub>GS</sub> =-4.5V, I <sub>D</sub> =-2.0A		0.090	0.100	Ω
		V <sub>GS</sub> =-2.5V, I <sub>D</sub> =-1.0A		0.110	0.130	
Forward transconductance <sup>a</sup>	g <sub>fs</sub>	V <sub>DS</sub> =-5V, I <sub>D</sub> =-2.0A	4.0	6.5		S
<b>Dynamic<sup>b</sup></b>						
Input capacitance	C <sub>iss</sub>	V <sub>DS</sub> =-10V, V <sub>GS</sub> =0V, f =1MHz		285		pF
Output capacitance	C <sub>oss</sub>			58		
Reverse transfer capacitance	C <sub>rss</sub>			32		
Total gate charge	Q <sub>g</sub>	V <sub>DS</sub> =-10V, V <sub>GS</sub> =-4.5V, I <sub>D</sub> =-2A		5.5	10	nC
				2.9	6	
Gate-source charge	Q <sub>gs</sub>	V <sub>DS</sub> =-10V, V <sub>GS</sub> =-2.5V, I <sub>D</sub> =-2A		045		
Gate-drain charge	Q <sub>gd</sub>			0.75		
Gate resistance	R <sub>g</sub>	f =1MHz		6.0		Ω
Turn-on delay time	t <sub>d(on)</sub>	V <sub>DD</sub> =-10V, R <sub>L</sub> =5Ω, I <sub>D</sub> =-1A, V <sub>GEN</sub> =-4.5V, R <sub>g</sub> =3Ω		9.8	20	ns
Rise time	t <sub>r</sub>			4.9	60	
Turn-off delay time	t <sub>d(off)</sub>			20.5	50	
Fall time	t <sub>f</sub>			7.0	20	
<b>Drain-source body diode characteristics</b>						
Continuous source-drain diode current	I <sub>s</sub>	T <sub>c</sub> =25°C			-1.3	A
Pulse diode forward current <sup>a</sup>	I <sub>SM</sub>				-10	
Body diode voltage	V <sub>SD</sub>	I <sub>s</sub> =-1.0A		-0.8	-1.2	V

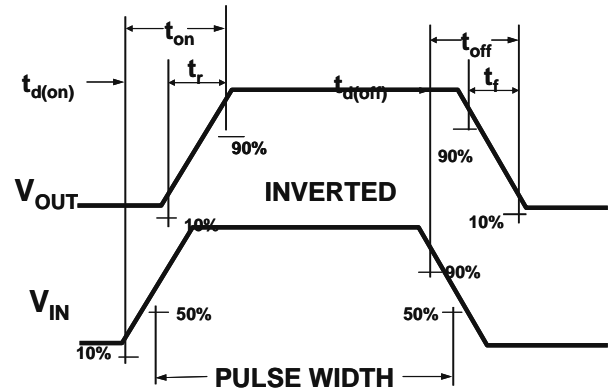
**Notes :**

- a.Pulse Test : Pulse Width < 300μs, Duty Cycle ≤2%.
- b.Guaranteed by design not subjected to production testing.

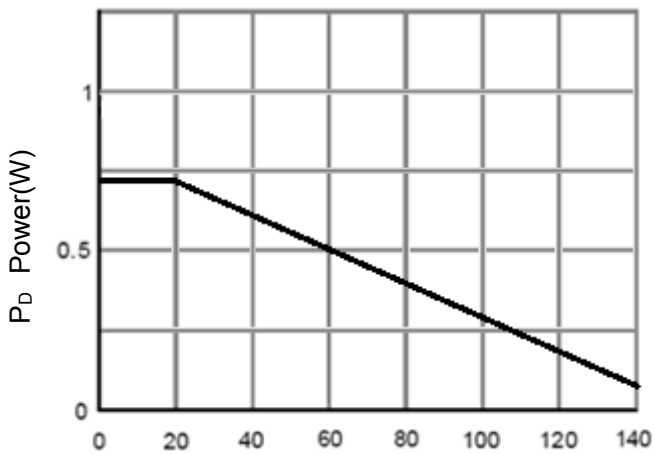
**Typical Electrical and Thermal Characteristics**



**Figure 1: Switching Test Circuit**

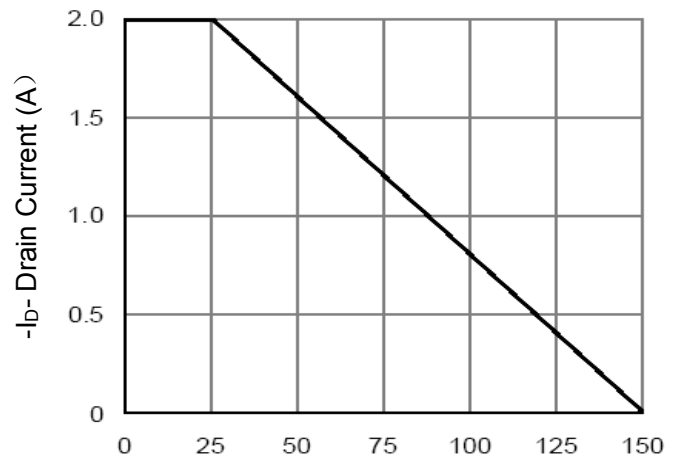


**Figure 2: Switching Waveforms**



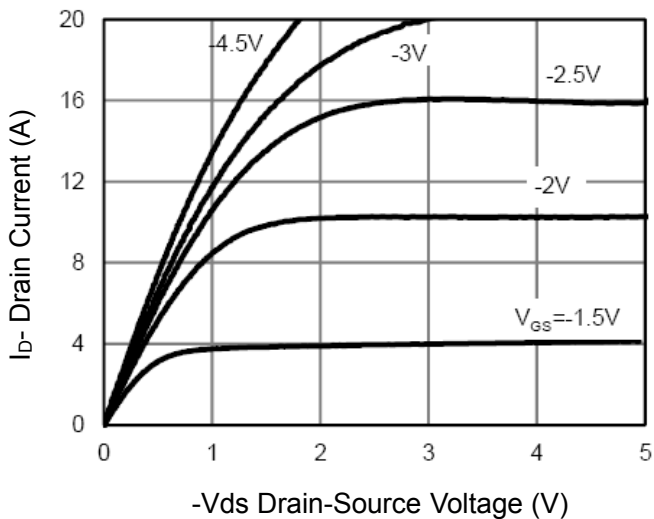
T<sub>J</sub>-Junction Temperature(°C)

**Figure 3 Power Dissipation**



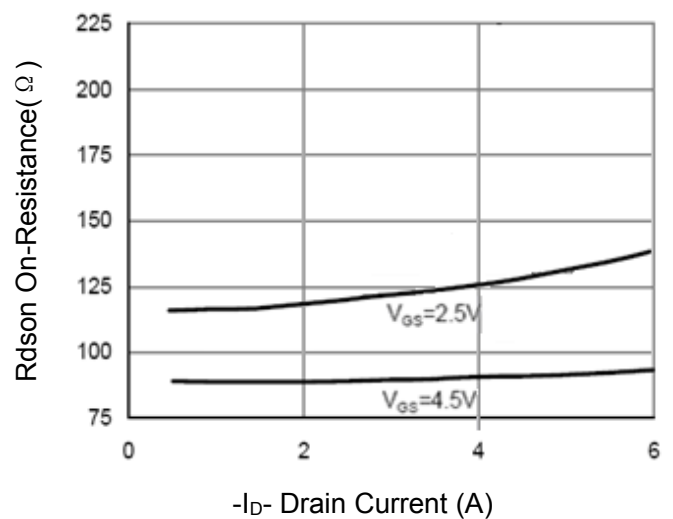
T<sub>J</sub>-Junction Temperature(°C)

**Figure 4 Drain Current**



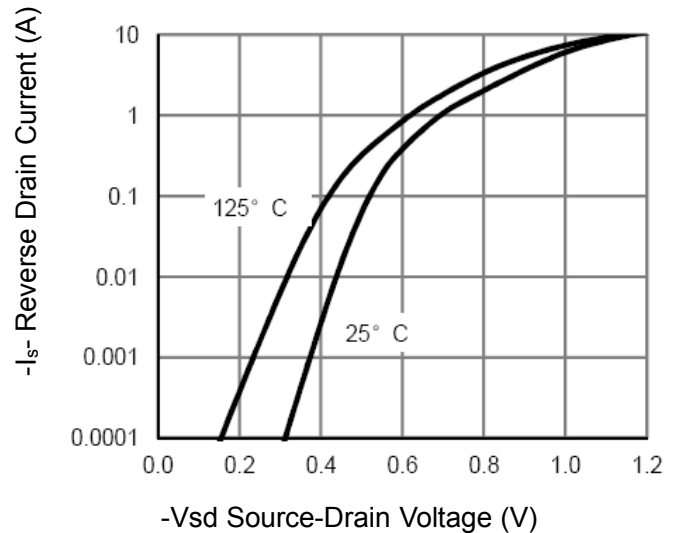
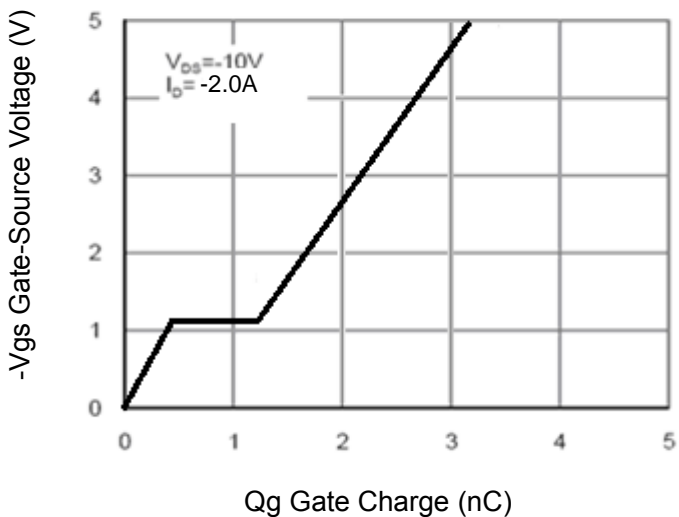
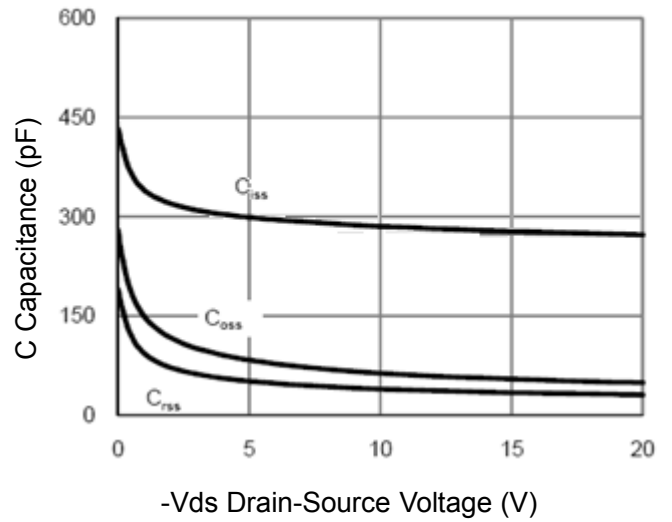
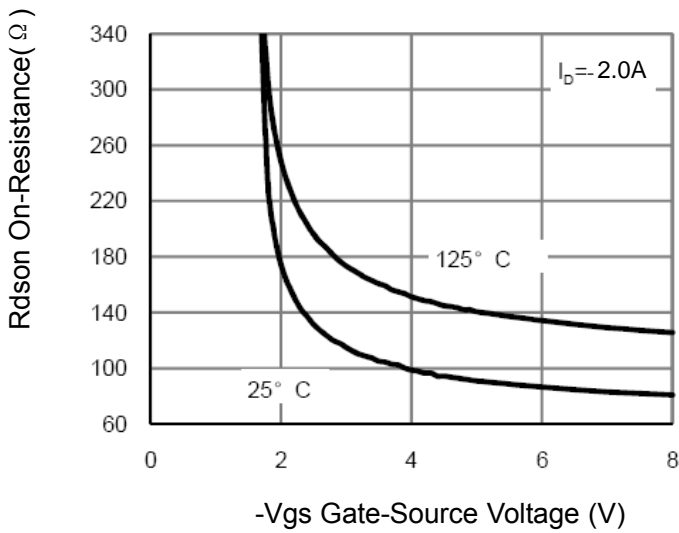
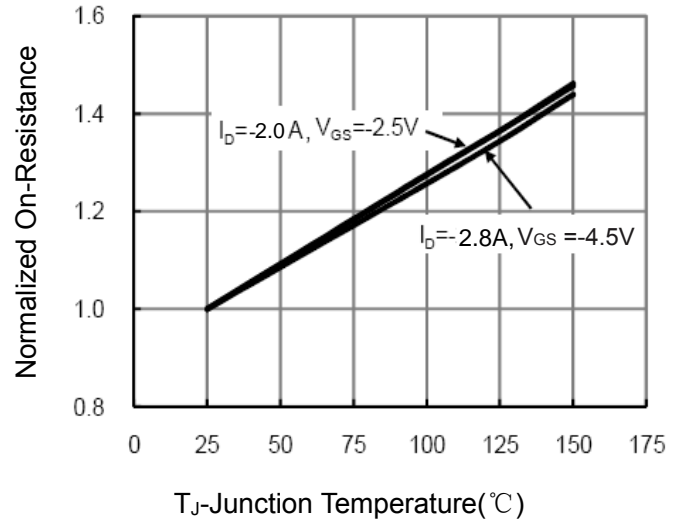
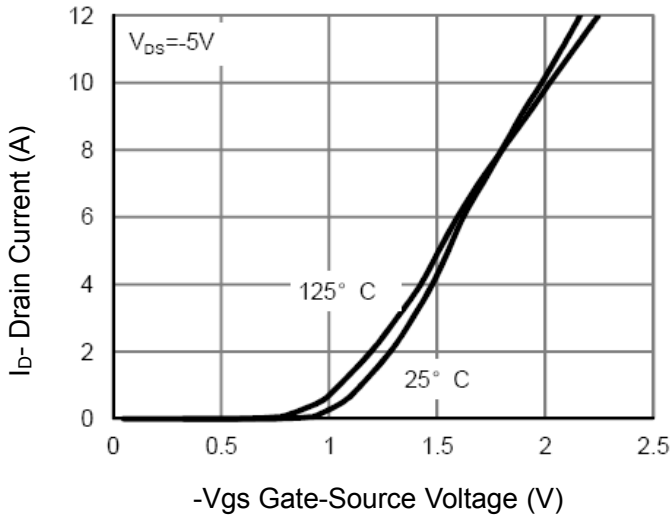
-V<sub>ds</sub> Drain-Source Voltage (V)

**Figure 5 Output Characteristics**



-I<sub>D</sub>- Drain Current (A)

**Figure 6 Drain-Source On-Resistance**



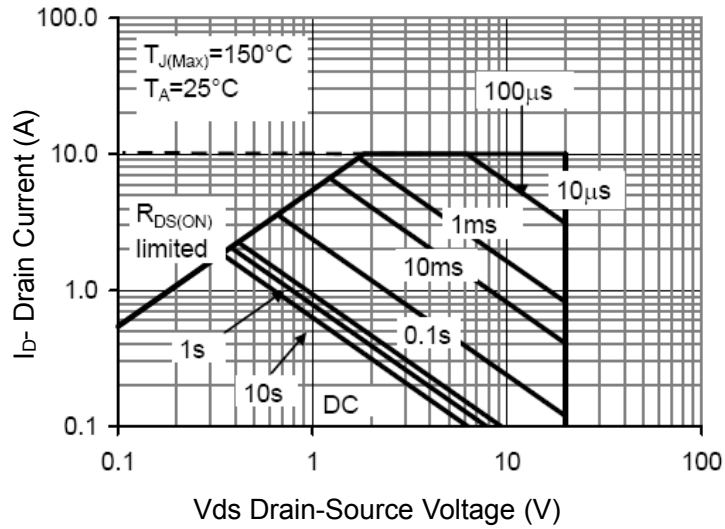


Figure 13 Safe Operation Area

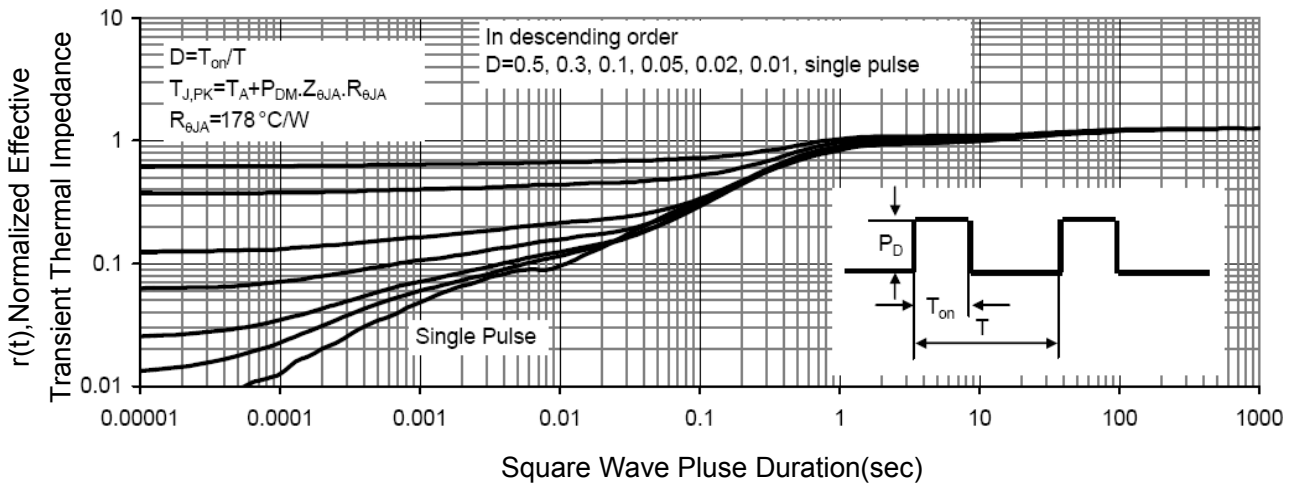
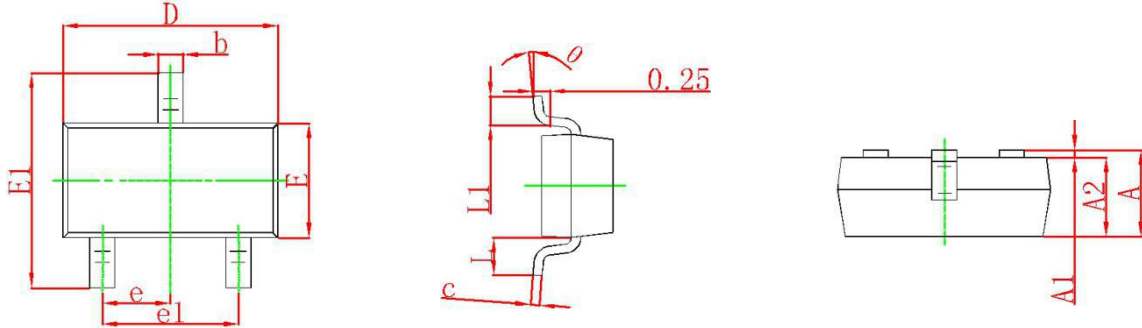


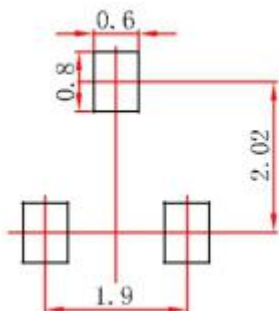
Figure 14 Normalized Maximum Transient Thermal Impedance

**SOT-23 Package Outline Dimensions**



Symbol	Dimensions In Millimeters		Dimensions In Inches	
	Min	Max	Min	Max
A	0.900	1.150	0.035	0.045
A1	0.000	0.100	0.000	0.004
A2	0.900	1.050	0.035	0.041
b	0.300	0.500	0.012	0.020
c	0.080	0.150	0.003	0.006
D	2.800	3.000	0.110	0.118
E	1.200	1.400	0.047	0.055
E1	2.250	2.550	0.089	0.100
e	0.950 TYP		0.037 TYP	
e1	1.800	2.000	0.071	0.079
L	0.550 REF		0.022 REF	
L1	0.300	0.500	0.012	0.020
θ	0°	8°	0°	8°

**SOT-23 Suggested Pad Layout**



Note:  
 1. Controlling dimension: in millimeters.  
 2. General tolerance: ±0.05mm.  
 3. The pad layout is for reference purposes only.

## X-ON Electronics

Largest Supplier of Electrical and Electronic Components

*Click to view similar products for [MOSFET](#) category:*

*Click to view products by [TuoFeng](#) manufacturer:*

Other Similar products are found below :

[614233C](#) [648584F](#) [MCH3443-TL-E](#) [MCH6422-TL-E](#) [FDPF9N50NZ](#) [FW216A-TL-2W](#) [FW231A-TL-E](#) [APT5010JVR](#) [NTNS3A92PZT5G](#)  
[IRF100S201](#) [JANTX2N5237](#) [2SK2464-TL-E](#) [2SK3818-DL-E](#) [FCA20N60\\_F109](#) [FDZ595PZ](#) [STD6600NT4G](#) [FSS804-TL-E](#) [2SJ277-DL-E](#)  
[2SK1691-DL-E](#) [2SK2545\(Q,T\)](#) [D2294UK](#) [405094E](#) [423220D](#) [MCH6646-TL-E](#) [TPCC8103,L1Q\(CM](#) [367-8430-0972-503](#) [VN1206L](#)  
[424134F](#) [026935X](#) [051075F](#) [SBVS138LT1G](#) [614234A](#) [715780A](#) [NTNS3166NZT5G](#) [751625C](#) [873612G](#) [IRF7380TRHR](#)  
[IPS70R2K0CEAKMA1](#) [RJK60S3DPP-E0#T2](#) [RJK60S5DPK-M0#T0](#) [APT5010JVFR](#) [APT12031JFLL](#) [APT12040JVR](#) [DMN3404LQ-7](#)  
[NTE6400](#) [JANTX2N6796U](#) [JANTX2N6784U](#) [JANTXV2N5416U4](#) [SQM110N05-06L-GE3](#) [SIHF35N60E-GE3](#)