

深圳市拓展光电有限公司

TuoZhan Optoelectronics Company Limited

产品规格书

Product Specification

产品料号/ Part No.	P2-0603W7YS2-06T-001		
产品名称/ Product Name	0603 紫罗兰		
客户名称/ Customer Name			
客户料号/ Customer No			
生效日期/ Effective Date			
制作 Prepared	审核 Checked	核准 Approved	业务 Sales
客户确认（盖章） Customer confirmation（Stamp）			

地址：深圳市宝安区西乡铁岗宝田一路 369 号

TEL:0755-29632541

Address: No.369,Baotian Road,Tiegang,xixiang,Baoan District, Shenzhen

Tel:0755-29632541

注：如中英译文有冲突请以中文为准。

Note: In case of any conflict between Chinese and English translations, the Chinese version shall prevail.



1. 产品描述 / Product Description:

- 外观尺寸 (L/W/H) / Product Dimensions: 1.6*0.8*0.6 mm:
- 防潮铝袋标准包装 / EIA Standard Packing:
- 符合 ROHS 要求 / Meet ROHS requirements:
- 适用于无铅回流焊 / Suitable for lead-free reflow soldering:



胶体颜色 / Lens color	<input type="checkbox"/> 水清透明 / Water clear	<input type="checkbox"/> 雾状 / Diffused	<input checked="" type="checkbox"/> 荧光粉状 / Fluorescent powder
发光颜色 / Luminous color	<input type="checkbox"/> 红外光 / Infrared light	<input type="checkbox"/> 红光 / Red	<input type="checkbox"/> 橙光 / Orange
	<input type="checkbox"/> 黄绿光 / Yellow-Green	<input type="checkbox"/> 黄 / Yellow	<input type="checkbox"/> 蓝光 / Blue
	<input type="checkbox"/> 翠绿光 / Green	<input type="checkbox"/> 紫光 / Purple	<input type="checkbox"/> 其他 / other <u>紫罗兰</u>
	<input type="checkbox"/> 白光 / White		

2. 产品主要应用 / Product Applications:

- 背光 / Backlight
- 发光指示灯 / Indicator light
- 照明 / Lighting
- 红外应用系统 / Infrared Application System
- 其他 / Others _____

3. 外观及建议焊盘尺寸 / Appearance and recommended pad size:

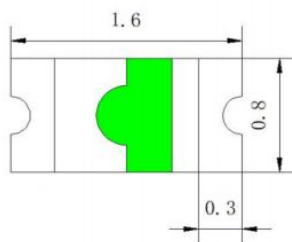
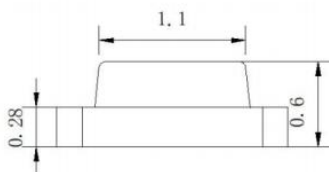
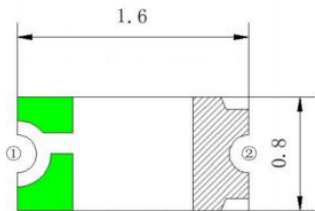

Recommended Solder Pad Design 推荐焊盘设计

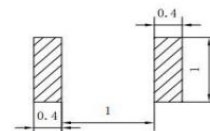

For reflow soldering

注 / Note:

1. 单位: 毫米 (mm) / Unit: mm.
2. 公差: 如无特别标注则为 ±0.10mm / Tolerances are ±0.10mm unless mentioned.

4.最大绝对额定值/Absolute Maximum Ratings: (Ta=25℃)

参数 Parameter	符号 Symbol	额定值 Value	单位 Unit
消耗功率 Power Dissipation	Pd	W:90	mW
最大脉冲电流* Max Pulse Current	IFP	40	mA
直流工作电流 DC Forward Current	IF	30	mA
反向电压 Reverse breakdown Voltage	VR	5	V
抗静电能力(人体模式)* Electrostatic Discharge Threshold (HBM)	ESD	W:2000V	V
工作环境温度 Operating Temperature	Topr	-40 to 85℃	℃
储存环境温度 Storage Temperature	Tstg	-40 to 85℃	℃
焊接温度 Soldering Temperature	Tsol	回流焊/ soldering:260℃/10S 手工焊/ Hands soldering:320℃/3S	℃

注/Note: *: 占空比 1/10, 脉冲宽 0.1ms/Duty cycle 1/10, pulse width 0.1 ms.

*: 静电测试属于破坏性测试, 只代表抽测数据/Static tests are Destructive testing and only represent random sampling data.

5. 建议焊接温度曲线/Recommended Reflow Soldering Temperature Curve:

无铅焊接：(Lead-free Soldering)

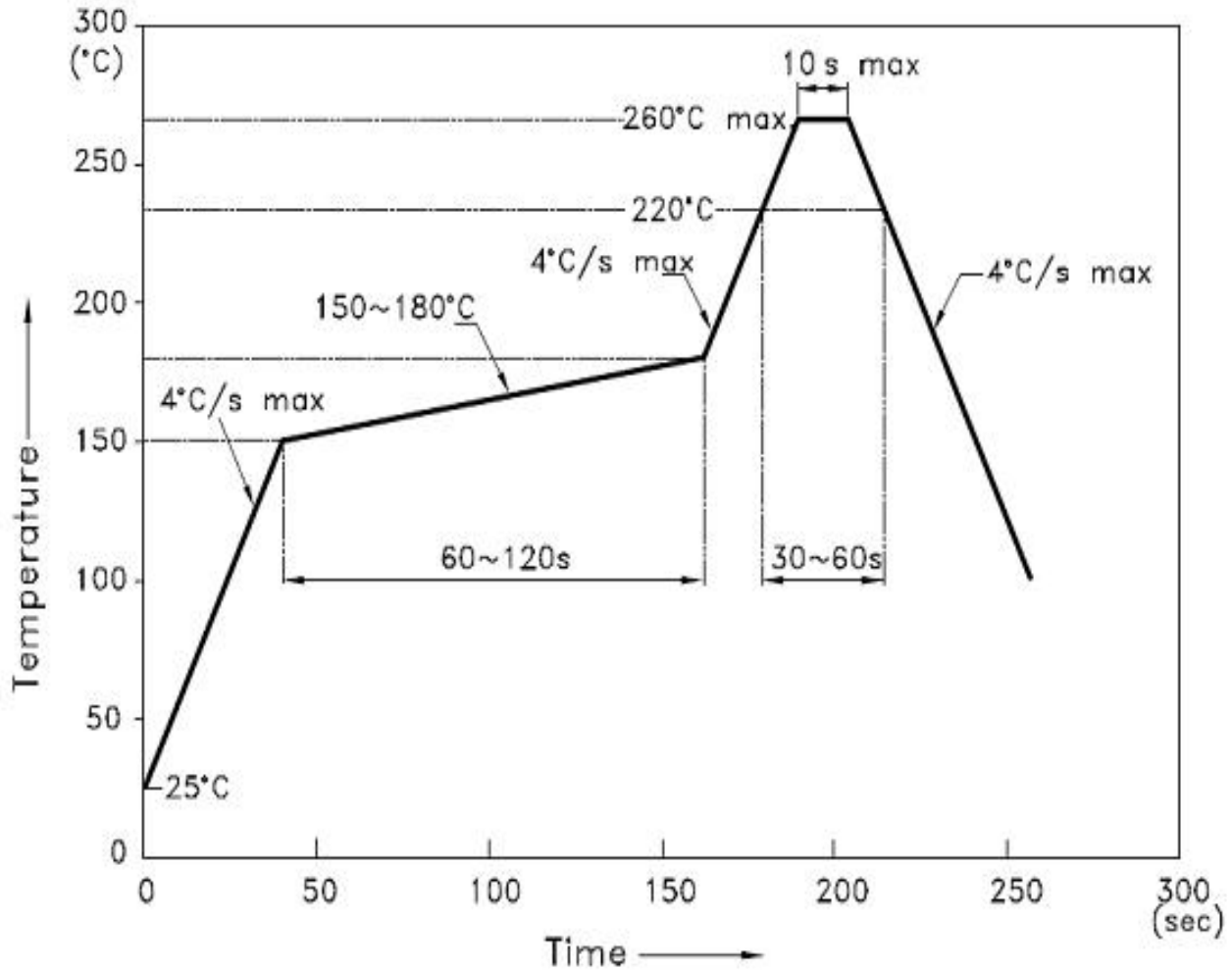

注/ Note:

1. 灯珠在温度较高时不要施加外力在灯珠上。

Do not apply external force on led lamp beads when the temperature is high.

2. 回流焊不建议超过两次；若需两次过炉，其时间不可超过 12H。

Reflow welding more than twice is not recommended; If twice time necessary, the interval time shall not exceed 12H.

3. 回流焊是建议的焊接加工方式，其它焊接方式可能会对灯珠造成损坏。

Reflow soldering is recommended, others might cause damages to the LEDs.

6.光电特性参数： Photoelectric characteristic parameters(Ta=25℃)：

参数 Parameter	符号 Symbol	颜色 Color	最小值 Min	典型值 Typ	最大值 Max	单位 Unit	测试条件 Test condition
亮度 Luminous intensity	Iv	W	50	---	100	mcd	IF=5mA
正向电压 Forward Voltage	VF	W	2.6	---	3.0	V	IF=5mA
Chromatic coordinates 色坐标	X:Y		---	X:0.2057 Y:0.0634	---		IF=5mA
色温 Color temperature	Tc	W	---	100000	---	K	IF=5mA
反向漏电流 Reverse Current	IR		---	---	3	uA	VR=5V
半功率视角 Half Power View	2θ1/2		---	120	---	deg	IF=5mA

注/Note:

1.测量误差：电压±0.1V，亮度±10%，波长 (X,Y)±1nm/±0.01。

Measurement errors : Vf ±0.1V

Luminous Intensity : ±10%

Wavelength(x,y) : ±1nm/±0.01



6.1 色区 BIN (温度=25℃, 测试电流=5mA) :

Color zone bin (TA=25℃, IF=5mA):

色区代码	x1	y1	x2	y2	x3	y3	x4	y4
RU2	0.1584	0.0419	0.1706	0.0496	0.1779	0.0382	0.1657	0.0305
RU3	0.1706	0.0496	0.1827	0.0571	0.1898	0.0458	0.1779	0.0382
RU4	0.1827	0.0571	0.1946	0.0647	0.2019	0.0533	0.1898	0.0458
RU5	0.1946	0.0647	0.2066	0.0724	0.2139	0.0610	0.2019	0.0533
RU6	0.2066	0.0724	0.2186	0.08	0.2258	0.0686	0.2139	0.0610
RU7	0.2186	0.08	0.2307	0.0877	0.2379	0.0763	0.2258	0.0686

6.2 色块图 (温度=25℃, 测试电流=5mA) :

Color block diagram(TA=25℃, IF=5mA):

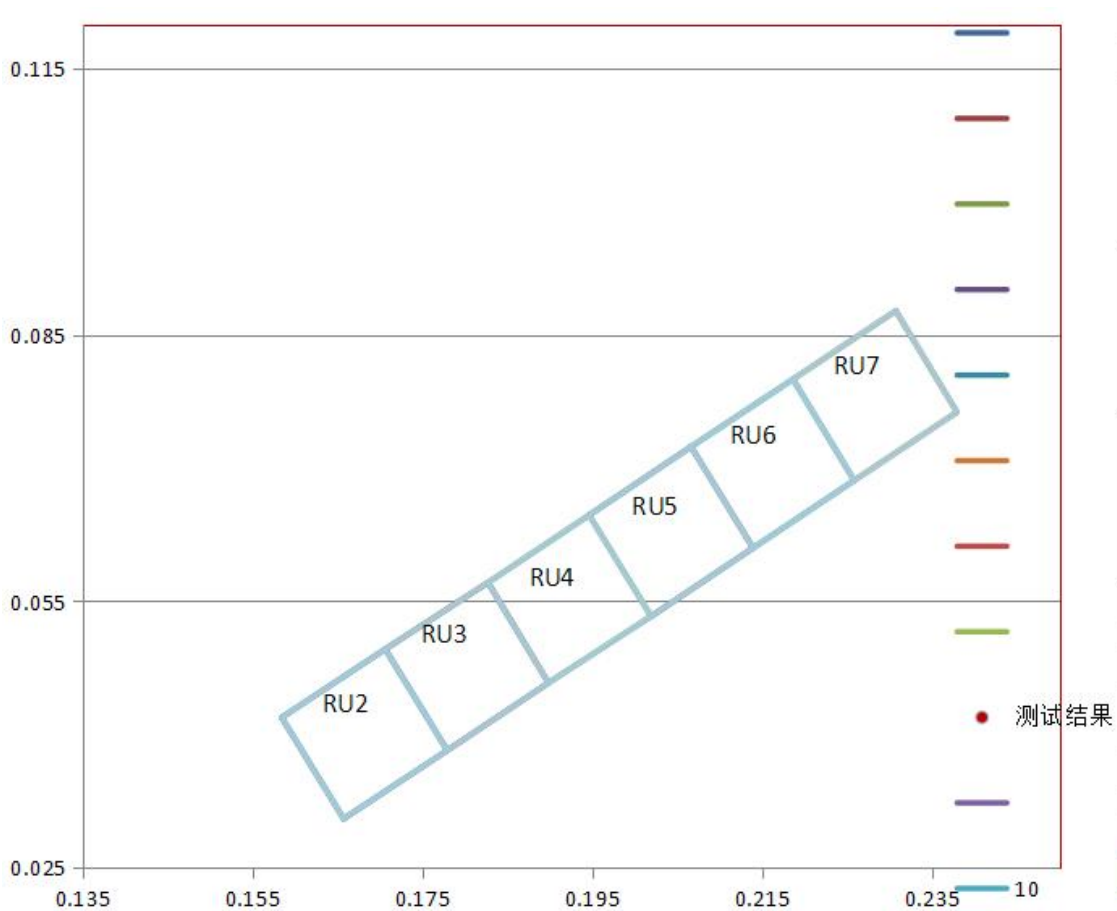



7. 光电参数代表值特征曲线：Typical Optical-Electronic Characteristic Curves

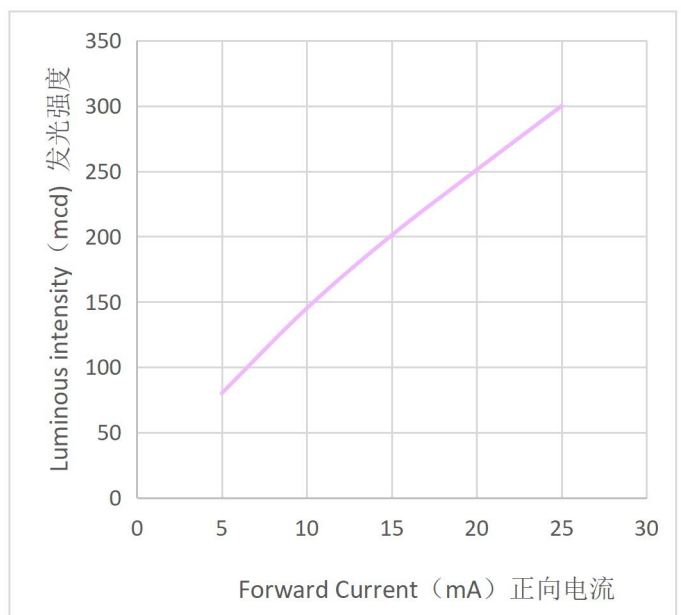
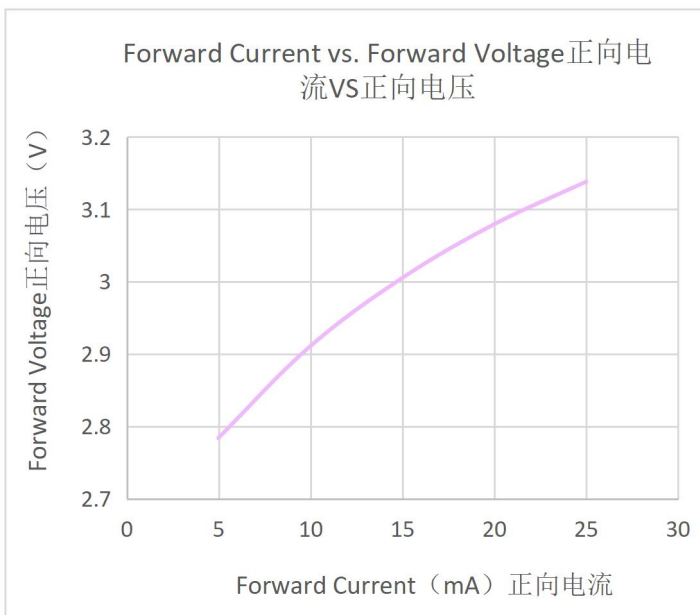
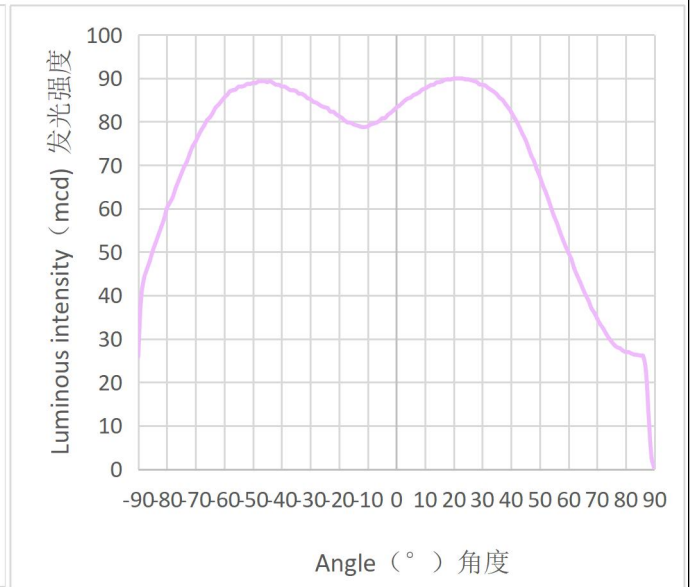
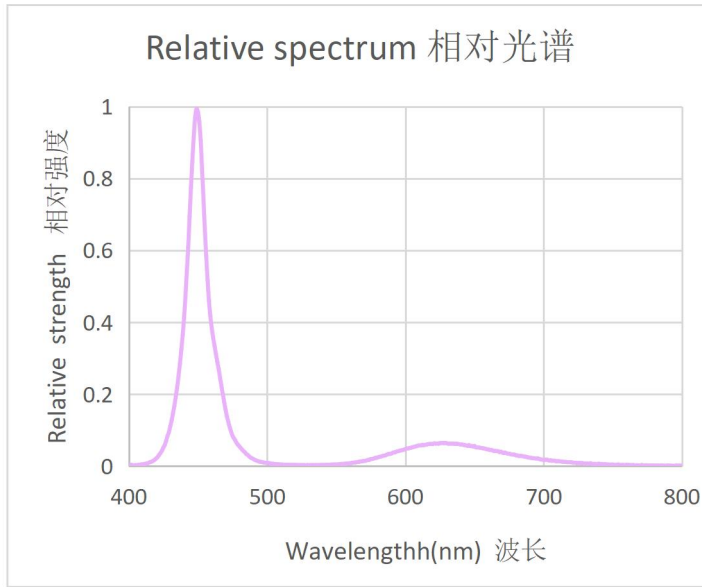

8. 标签标识/Label Identifier:

 拓展光电 TUOZHANGUANGDIAN			
Part NO:			
Lot NO:			
IF (mA):	QTY (PCS):		
VF (v):	V(mcd):		
WL(nm):	BIN:		
Date:	QC:		

9. 包装载带与圆盘尺寸/Packing tape and Disc size:

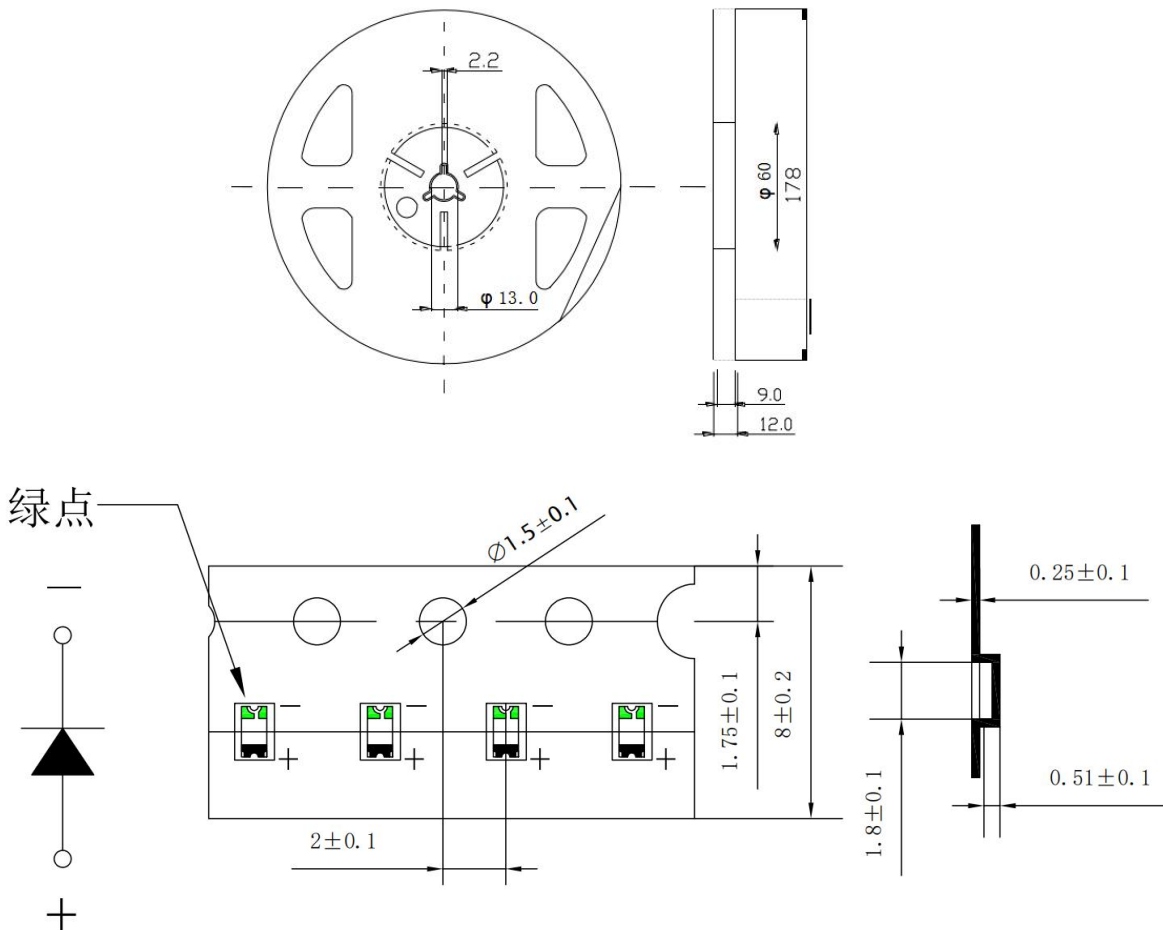

注/Note:

1. 尺寸单位为毫米 (mm) / Size in mm.
2. 尺寸公差是 $\pm 0.1\text{mm}$ / Dimensional Tolerance $\pm 0.1\text{mm}$.
3. 包装数量: 4K / Package quantity: 4000PCS.

10. 圆盘及载带卷出方向及空穴规格 / Roll out direction and hole specification of disk and carrier band:

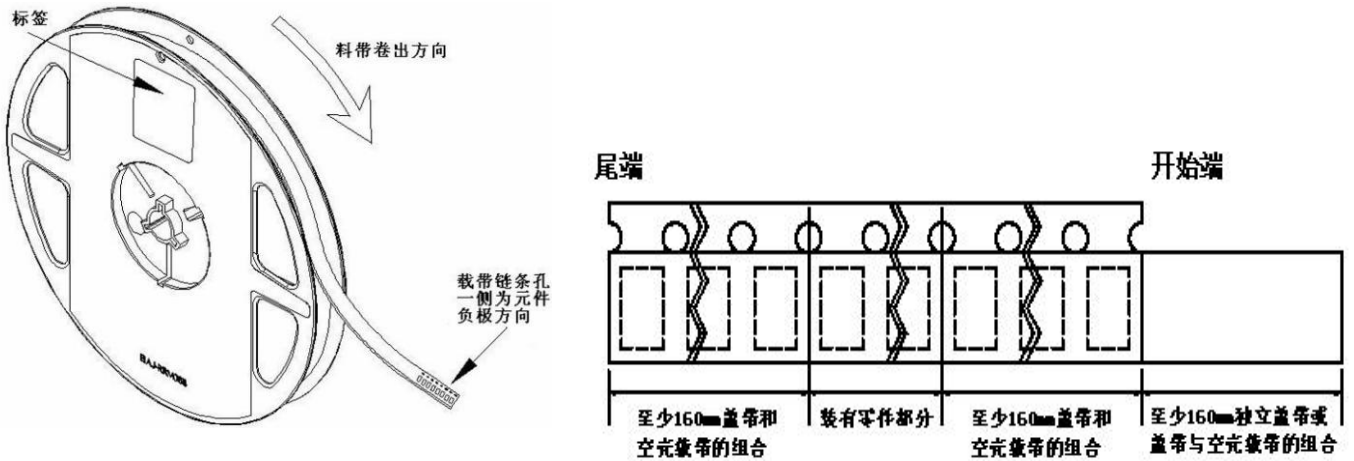

11. 内包装及外包装 / Inner packing and outer packing:

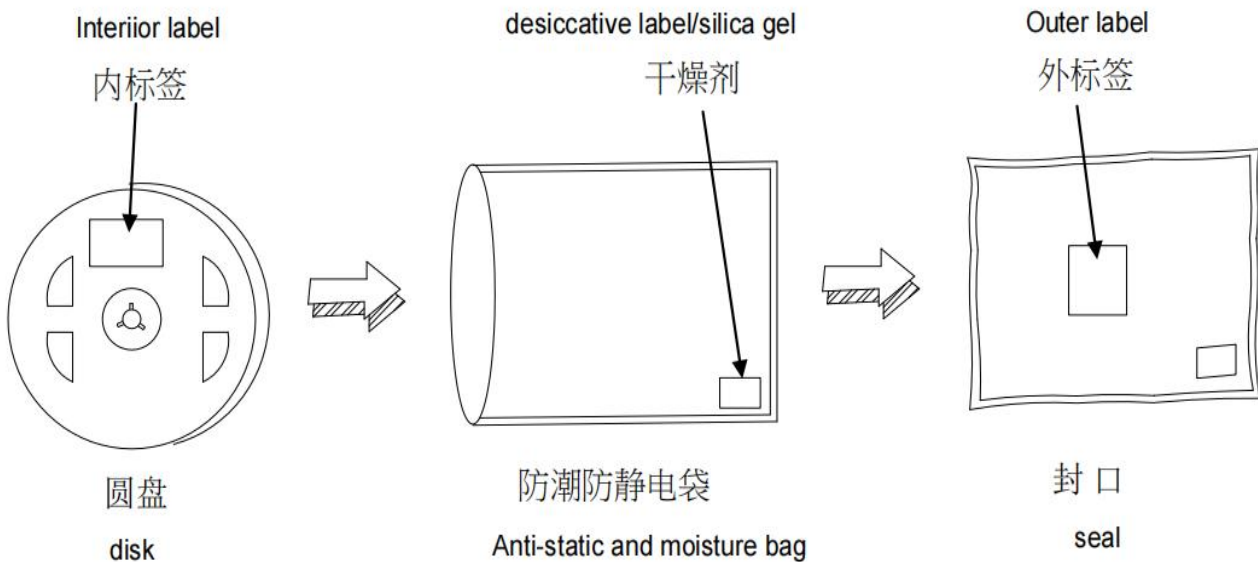

12. 信赖性实验/Reliability Test:

实验项目 Test Items	参考标准 Reference	实验条件 Test Conditions	时间 Time	样品数 Quantity	判据 Criterion
冷热冲击 Thermal Shock	MIL-STD-202G	-40°C(15min)←→100°C(15min)	循环 200 次 200 cycles	22	0/22
湿热循环 Temperature And Humidity Cyclic	JEITA ED-4701 200 203	(-10~65)°C , (0~90)%RH 24hrs./1cycle	循环 10 次 10 cycles	22	0/22
高温贮存 High Temperature Storage	JEITA ED-4701 200 201	Ta=100°C	1000h	22	0/22
低温贮存 Low Temperature Storage	JEITA ED-4701 200 202	Ta=-40°C	1000h	22	0/22
常温寿命 Lifespan test	JESD22-A108D	Ta=25°C IF =10mA	1000h	22	0/22
耐焊接热 Resistance to Soldering Heat	GB/T 4937, II ,2.2&2.3	Tsol*=260°C 10secs.	2 次 2 times	22	0/22

13. 失效判定标准/Failure criteria:

测试项目 Test Items	符号 Symbol	测试条件 Test Conditions	判定标准 Criteria For Judging Damage
正向电压 Forward Voltage	V _F	I _F = I _{FT}	初始值±10% Initial Data±10%
反向电流 Reverse Current	I _R	V _R = 5V	I _R ≤ 10μA
光强 Luminous Intensity	I _V	I _F = I _{FT}	I _V 衰减 ≤ 50% IV degradation ≤ 50%
耐焊接热 Resistance to Soldering Heat			无死灯 No dead light

14.使用注意事项/Cautions:

a.使用/using:

1. LED 是电流驱动元件，电压的细微变化会产生较大的电流波动,导致元件遭到破坏。客户应使用电阻串联作限流保护。

Leds are current-driven components, and small changes in voltage will produce large current fluctuations, leading to component damage. Customers should use resistors in series for current limiting protection.

2. 为了确保多颗 LED 并联使用时光色一致，建议每条支路使用单独电阻,如下图模式 A 所示；如采用下图模式 B 所示电路，LED 光色可能因每一颗 LED 不同的伏安特性而造成光色差异。

In order to ensure that CIE are consistent when multiple leds are connected in parallel, it is recommended to use separate resistors for each branch, as shown in mode A in below. If the circuit shown in mode B below is used, the LED light color may be different due to the different volt-ampere characteristics of each LED.

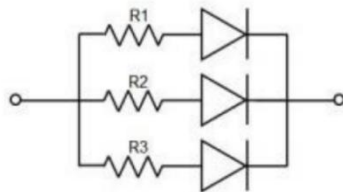

电路模式 A
Circuit model A

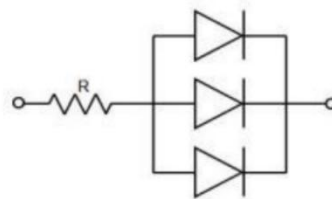

电路模式 B
Circuit model B

3. 过高的环境温度会影响 LED 的亮度以及其他性能,所以为能使 LED 有较好的性能表现应远离热源。

Too high ambient temperature will affect the brightness of LEDS and its properties, please be away from the heat so as to keep their performance much better.

b.存储/Storage:

1. 未打开原始包装的情况下，建议储存的环境为:温度:5°C~30°C；湿度:60%RH 以下，当库存超过 6 个月，使用前应做除湿处理：条件 60°C/12 小时。

When the original package is not opened, the recommended storage conditions are: Temperature: 5 ° C ~ 30 ° C; Humidity: 60% Rh below, when the stock exceeds 6 months, dehumidification should be done before using: 60 ° C/12 hours



2. 打开原始包装后，建议储存环境为：温度 5~30°C；湿度 30%RH 以下。

After opening the original packaging, the recommended storage environment is: temperature 5 ~ 30 ° C, humidity 30% Rh below

3. LED 是湿度敏感元件，为避免元件吸湿，建议打开包装后，将其储存在有干燥剂的密闭容器内，或者储存在氮气防潮柜内。

LED is a component that is sensitive to humidity, which requires to be stored in sealed container with desiccant or nitrogen moisture-proof cabinet to avoid moisture absorption after unpacking.

4. 此款灯珠防潮等级为 MSL3；打开包装后，元件应该在 168 小时内 (7 天) 使用；且贴片后应尽快做焊接。

The moisture-proof grade of this LED chip is MSL3; Components should be used within 168 hours (7 days) after unpacking; And after the patch should be done as soon as possible welding.

5. 如果干燥剂失效或者元件暴露于空气中超过 168 小时 (7 天)，应作除湿处理。

Component should be dehumidified when it is exposed to the air for more than 168hrs(7days) or desiccant expired.

c. ESD 静电防护 / Electrostatic Protection:

1. LED (特别是 InGaN 结构的蓝色、翠绿色、紫色、白色、粉红色 LED) 是静电敏感元件，静电或者电流过载会破坏 LED 结构。LED 受到静电伤害或电流过载可能会导致性能异常，比如漏电流过大，VF 变低，或者无法点亮等等。所以请注意以下事项：

LED (especially InGaN structure of blue, green, purple, white, pink LED) is electrostatic sensitive components, static electricity or current overload will damage the LED structure. LED static damage or current overload may lead to abnormal performance, such as large leakage current, low VF, or failure to light and so on. So please note the following:

2. 接触 LED 时应佩戴防静电腕带或者防静电手套。

Wear an ESD wrist strap or ESD gloves when touching leds.

3. 所有的机器设备、工制具、工作桌、料架等等，应该做适当的接地保护 (接地阻抗值 10Ω 以内)。

All machines, tools, worktables, racks, etc., should be properly grounded (within 10Ω ground resistance).

4. 储存或搬运 LED 应使用防静电料袋、防静电盒及防静电周转箱，严禁使用普通塑料制品。

Anti-static material bags, anti-static boxes and anti-static turnover boxes should



be used to store or transport LED. Ordinary plastic products are strictly prohibited.

5. 建议在作业过程中，使用离子风扇来压制静电的产生。

It is recommended to use ion fans to suppress static electricity generation during operation.

6. 距离 LED 元件 1 英尺距离的环境范围内静电场电压小于 100V。

The electrostatic field voltage is less than 100V within the ambient range at a distance of 1ft from the LED element

d.清洗/Cleaning:

1. 建议使用异丙醇等醇类溶液清洗 LED，严禁使用腐蚀性溶液清洗。

It is recommended to use alcohol solution such as isopropyl alcohol to clean LED. Corrosive solution is strictly prohibited

e.焊接/welding:

- 1.回流焊焊接条件参考第三页温度曲线。

Reflow welding conditions refer to the temperature curve on page 3.

- 2.回流焊焊接次数不得超过两次。

Reflow welding must not be performed more than twice.

- 3.只建议在修理和重工的情况下使用手工焊接；最高焊接温度不应超过 300 度，且须在 3 秒内完成。烙铁最大功率应不超过 30W。

Manual welding is only recommended for repair and heavy work. The maximum welding temperature should not exceed 300 degrees and must be completed within 3 seconds. The maximum power of the soldering iron should not exceed 30W.

- 4.焊接过程中,严禁在高温情况下碰触胶体。

During the welding process, it is forbidden to touch the colloid at high temperature.

- 5.焊接后,禁止对胶体施加外力，禁止弯折 PCB,避免元件受到撞击。

After welding, do not apply external force to colloid, do not bend PCB, to avoid the impact of components.

f.其他/others

1. 本规格所描述的 LED 定义应用在普通的电子设备范围(例如办公设备、通讯设备等等)。如果有更为严苛的信赖度要求，特别是当元件失效或故障时可能会直接危害到生命和健康时(如航天、运输、交通、医疗器械、安全保护等等)，请事先知会敝司业务人员。



The LED definitions described in this specification are applied to a range of common electronic equipment (e.g. office equipment, communication equipment, etc.). If there are more strict requirements of reliability, especially when the failure or failure of components may directly endanger life and health (such as aerospace, transportation, traffic, medical instruments, safety protection, etc.), please inform our business personnel in advance.

2. 高亮度 LED 产品点亮时可能会对人眼造成伤害，应避免从正上方直视。

High brightness LED products may cause damage to human eyes when lit. Avoid looking directly at them from above

3. 出于持续改善的目的，产品外观和参数规格可能会在没有预先通知的情况下作改良性变化。

For the purpose of continuous improvement, product appearance and specifications may be subject to benign changes without prior notice.

X-ON Electronics

Largest Supplier of Electrical and Electronic Components

Click to view similar products for [Standard LEDs - SMD category](#):

Click to view products by [TUOZHAN manufacturer](#):

Other Similar products are found below :

[LTST-C190KYKT](#) [LTST-C19GD2WT](#) [LTST-N683GBEW](#) [LTW-170ZDC](#) [LTW-M140SZS40](#) [LTW-M140ZVS](#) [598-8110-100F](#) [91-21SUBCS400-A6TR7](#) [AAAF5060QBFSEEZGS](#) [APT1608QGW](#) [99-213/R6C-AR2T1B/2C](#) [SML-LX0606SISUGC/A](#) [SML-LXR851SIUPGUBC](#) [LT1ED53A](#) [AM27ZGC03](#) [APFA3010SURKCGKQBDC](#) [APHK1608VGCA](#) [APT2012QGW](#) [LTST-008BGEW](#) [LTW-010DCG](#) [LTW-020ZDCG](#) [LTW-21TS5](#) [LTW-220DS5](#) [LO T67F-V1AB-24-1](#) [598-8330-117F](#) [CMDA20AYAA7D1S](#) [95-21SURCS530-A3TR10](#) [HSMQ-C177](#) [598-8040-100F](#) [598-8070-100F](#) [598-8140-100F](#) [598-8610-200F](#) [SML-LXL1209SYC/ATR](#) [CMD91-21VRC/TR7](#) [SML-512PWT86A](#) [SMF-2432GYC-TR](#) [EASV3015RGYA0](#) [LTST-C190KFKT-5A](#) [LTST-C194TBKT-5A](#) [CLX6E-FKC-CH1M1D1BB7C3D3](#) [SML-LXL0805USBC-TR](#) [SML-LX2835SYSUGCTR](#) [LTW-M670ZVS-M5](#) [APA2106ZGC/G](#) [CLMXB-FKA-CbcfghjnpACBB79463](#) [VFA1101W-5AY3B2-TR](#) [LCB P473-P2R2-3J7L-1-Z](#) [HSMR-C197](#) [LW A67C-S2U1-FK0KM0](#) [LW A673-P1S1-FK0PM0](#)