

2SA1015 TRANSISTOR (PNP)

FEATURES

- High voltage and high current
- Excellent h_{FE} Linearity
- Complementary to C1815

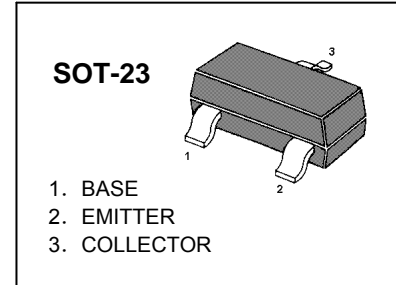

Absolute Maximum Ratings ($T_a = 25\text{ }^\circ\text{C}$)

Parameter	Symbol	Value	Unit
Collector Base Voltage	V_{CBO}	-50	V
Collector Emitter Voltage	V_{CEO}	-50	V
Emitter Base Voltage	V_{EBO}	-5	V
Collector Current	I_C	-150	mA
Base Current	I_B	-50	mA
Power Dissipation	P_{tot}	200	mW
Junction Temperature	T_j	150	$^\circ\text{C}$
Storage Temperature Range	T_s	- 65 to +150	$^\circ\text{C}$

Characteristics at $T_a = 25\text{ }^\circ\text{C}$

Parameter	Symbol	Min.	Max.	Unit	
DC Current Gain at $-V_{CE} = 6\text{ V}$, $-I_C = 2\text{ mA}$ at $-V_{CE} = 6\text{ V}$, $-I_C = 150\text{ mA}$	Current Gain Group O	h_{FE}	70	140	-
	Y	h_{FE}	120	240	-
	G	h_{FE}	200	400	-
		h_{FE}	25	-	-
Collector Base Cutoff Current at $-V_{CB} = 50\text{ V}$	I_{CBO}	-	-0.1	μA	
Emitter Base Cutoff Current at $-V_{EB} = 5\text{ V}$	I_{EBO}	-	-0.1	μA	
Collector Base Breakdown Voltage at $-I_C = 100\text{ }\mu\text{A}$	$V_{(BR)CBO}$	-50	-	V	
Collector Emitter Breakdown Voltage at $-I_C = 10\text{ mA}$	$V_{(BR)CEO}$	-50	-	V	
Emitter Base Breakdown Voltage at $-I_E = 10\text{ }\mu\text{A}$	$V_{(BR)EBO}$	-5	-	V	
Collector Emitter Saturation Voltage at $-I_C = 100\text{ mA}$, $-I_B = 10\text{ mA}$	$V_{CE(sat)}$	-	-0.3	V	
Base Emitter Saturation Voltage at $-I_C = 100\text{ mA}$, $-I_B = 10\text{ mA}$	$V_{BE(sat)}$	-	-1.1	V	
Gain Bandwidth Product at $-V_{CE} = 10\text{ V}$, $-I_C = 1\text{ mA}$	f_T	80	-	MHz	
Output Capacitance at $-V_{CB} = 10\text{ V}$, $f = 1\text{ MHz}$	C_{OB}	-	7	pF	

Typical Characteristics

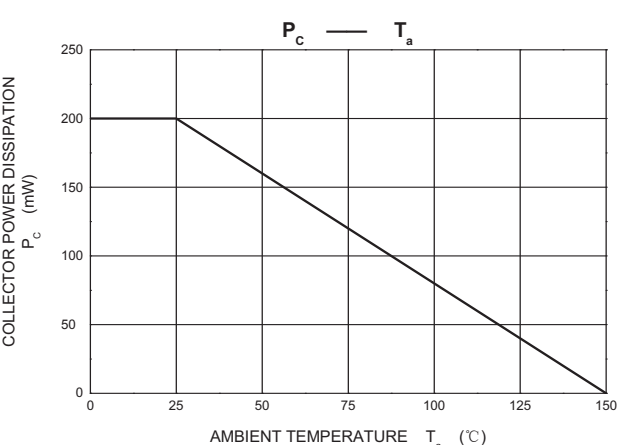
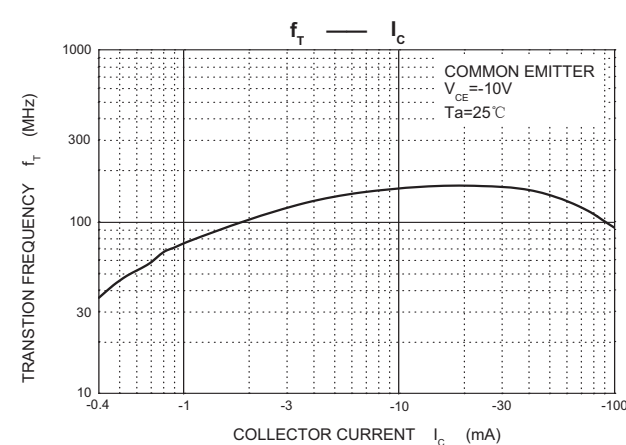
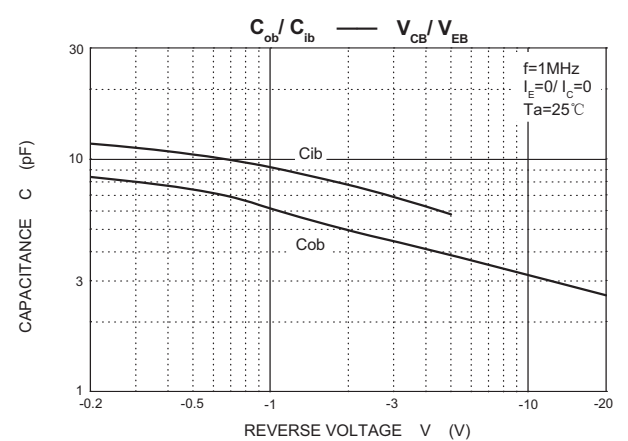
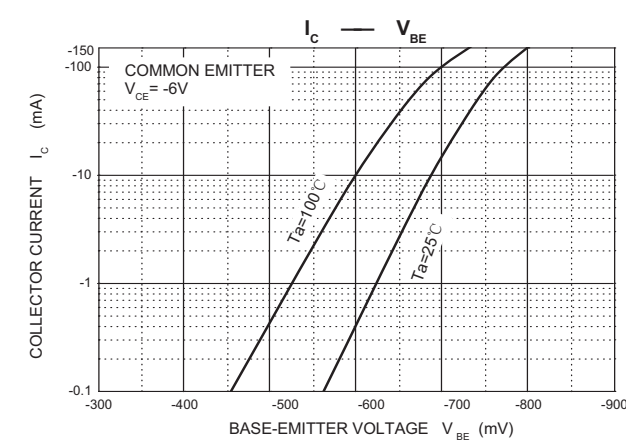
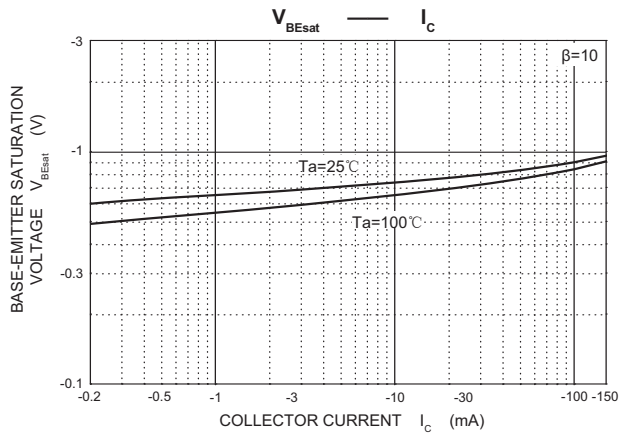
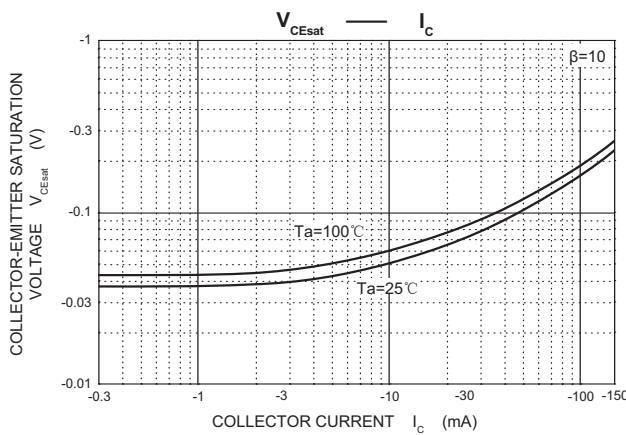
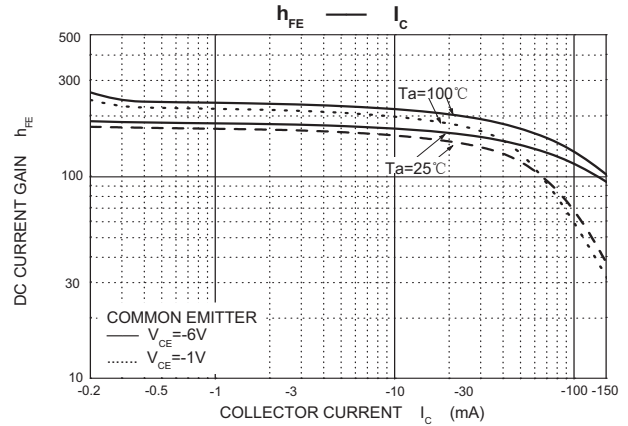
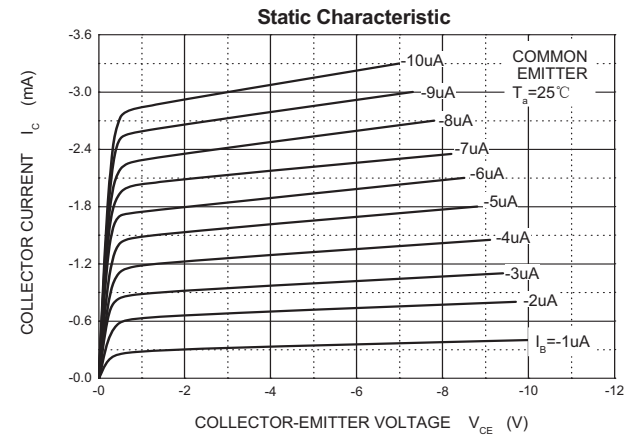

PACKAGE OUTLINE

Plastic surface mounted package; 3 leads

SOT-23

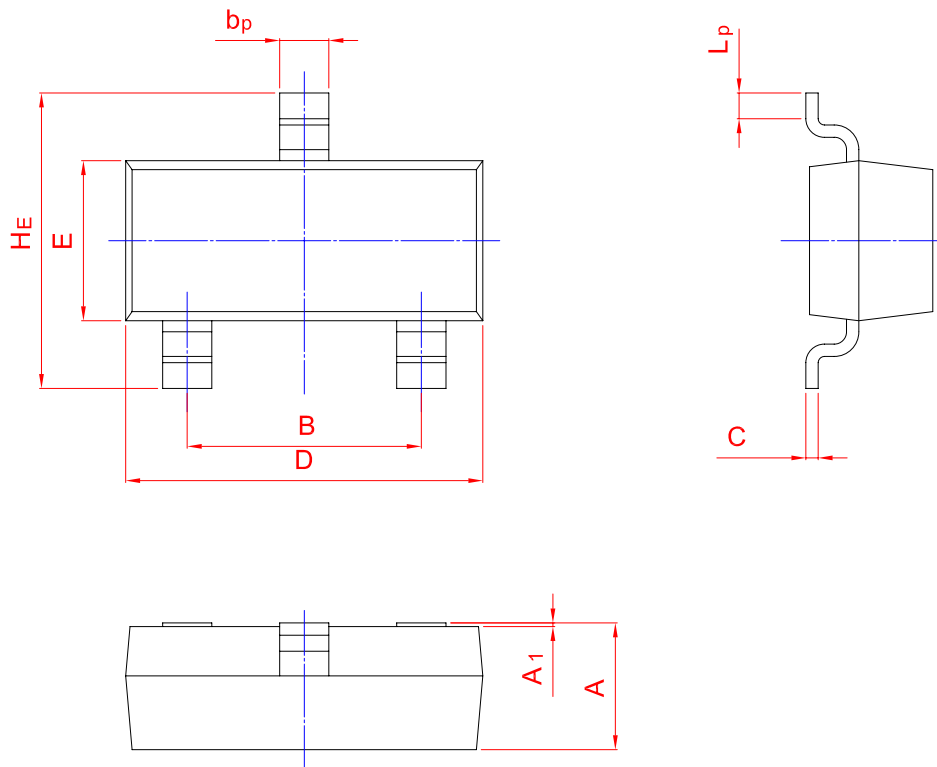
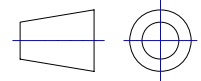

UNIT	A	B	bp	C	D	E	HE	A1	Lp
mm	1.40	2.04	0.50	0.19	3.10	1.65	3.00	0.100	0.50
	0.95	1.78	0.35	0.08	2.70	1.20	2.20	0.013	0.20

X-ON Electronics

Largest Supplier of Electrical and Electronic Components

Click to view similar products for [Bipolar Transistors - BJT category](#):

Click to view products by [TWGMC manufacturer](#):

Other Similar products are found below :

[619691C](#) [MCH4017-TL-H](#) [MJ15024/WS](#) [MJ15025/WS](#) [BC546/116](#) [BC556/FSC](#) [BC557/116](#) [BSW67A](#) [HN7G01FU-A\(T5L,F,T](#)
[NJVMJD148T4G](#) [NSVMMBT6520LT1G](#) [NTE187A](#) [NTE195A](#) [NTE2302](#) [NTE2330](#) [NTE2353](#) [NTE316](#) [IMX9T110](#) [NTE63](#) [NTE65](#)
[C4460](#) [SBC846BLT3G](#) [2SA1419T-TD-H](#) [2SA1721-O\(TE85L,F\)](#) [2SA1727TLP](#) [2SA2126-E](#) [2SB1202T-TL-E](#) [2SB1204S-TL-E](#) [2SC5488A-](#)
[TL-H](#) [2SD2150T100R](#) [SP000011176](#) [FMC5AT148](#) [2N2369ADCSM](#) [2SB1202S-TL-E](#) [2SC2412KT146S](#) [2SC4618TLN](#) [2SC5490A-TL-H](#)
[2SD1816S-TL-E](#) [2SD1816T-TL-E](#) [CMXT2207 TR](#) [CPH6501-TL-E](#) [MCH4021-TL-E](#) [BC557B](#) [TTC012\(Q\)](#) [BULD128DT4](#) [JANTX2N3810](#)
[Jantx2N5416](#) [US6T6TR](#) [KSF350](#) [068071B](#)