

## BCX54 THRU BCX56 TRANSISTOR(NPN)

### FEATURE

- PNP Complements to BCX51,BCX52,BCX53
- Low Voltage
- High Current

### APPLICATIONS

- Driver Stages of Audio Amplifiers

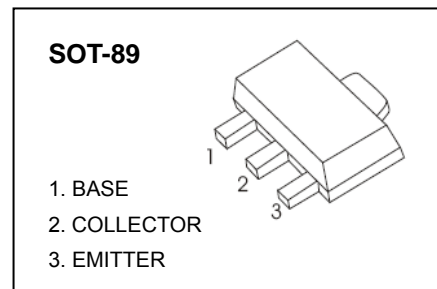

### MAXIMUM RATINGS ( $T_A=25^{\circ}\text{C}$ unless otherwise noted)

Symbol	Parameter	Value	Unit
$V_{CBO}$	Collector-Base Voltage	BCX54	45
		BCX55	60
		BCX56	100
$V_{CEO}$	Collector-Emitter Voltage	BCX54	45
		BCX55	60
		BCX56	80
$V_{EBO}$	Emitter-Base Voltage	5	V
$I_C$	Collector Current	1	A
$P_C$	Collector Power Dissipation	500	mW
$R_{\theta JA}$	Thermal Resistance From Junction To Ambient	250	$^{\circ}\text{C}/\text{W}$
$T_j$	Junction Temperature	150	$^{\circ}\text{C}$
$T_{stg}$	Storage Temperature	-55~+150	$^{\circ}\text{C}$

**ELECTRICAL CHARACTERISTICS (Ta=25°C unless otherwise specified)**

Parameter	Symbol	Test conditions	Min	Typ	Max	Unit
Collector-base breakdown voltage	$V_{(BR)CBO}$	$I_C=100\mu A, I_E=0$	BCX54	45		V
			BCX55	60		
			BCX56	100		
Collector-emitter breakdown voltage	$V_{(BR)CEO^*}$	$I_C=10mA, I_B=0$	BCX54	45		V
			BCX55	60		
			BCX56	80		
Emitter-base breakdown voltage	$V_{(BR)EBO}$	$I_E=100\mu A, I_C=0$	5			V
Collector cut-off current	$I_{CBO}$	$V_{CB}=30V, I_E=0$			0.1	$\mu A$
Emitter cut-off current	$I_{EBO}$	$V_{EB}=5V, I_C=0$			0.1	$\mu A$
DC current gain	$h_{FE(1)^*}$	$V_{CE}=2V, I_C=5mA$	40			
	$h_{FE(2)^*}$	$V_{CE}=2V, I_C=150mA$	63		250	
	$h_{FE(3)^*}$	$V_{CE}=2V, I_C=0.5A$	25			
Collector-emitter saturation voltage	$V_{CE(sat)^*}$	$I_C=0.5A, I_B=50mA$			0.5	V
Base-emitter voltage	$V_{BE^*}$	$V_{CE}=2V, I_C=0.5A$			1	V
Transition frequency	$f_T$	$V_{CE}=5V, I_C=10mA, f=100MHz$		130		MHz

**CLASSIFICATION OF  $h_{FE(2)}$** 

RANK	<b>BCX54</b>	<b>BCX54-10</b>	<b>BCX54-16</b>
	<b>BCX55</b>	<b>BCX55-10</b>	<b>BCX55-16</b>
	<b>BCX56</b>	<b>BCX56-10</b>	<b>BCX56-16</b>
RANGE	63 - 250	63 - 160	100 - 250

## TYPICAL CHARACTERISTICS

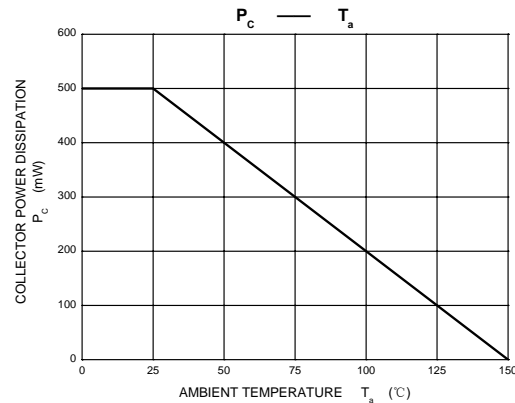
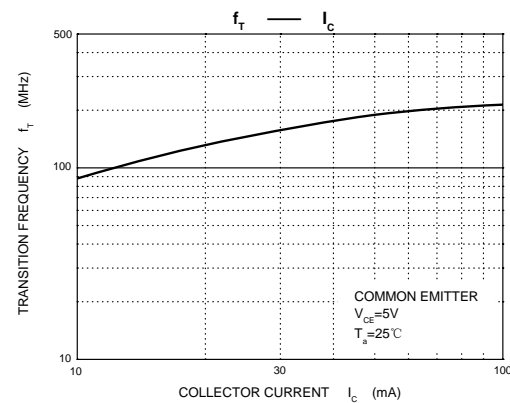
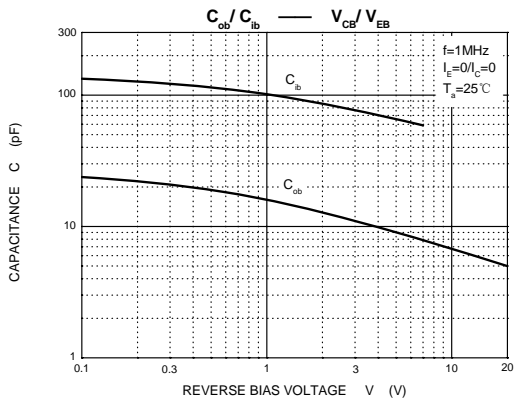
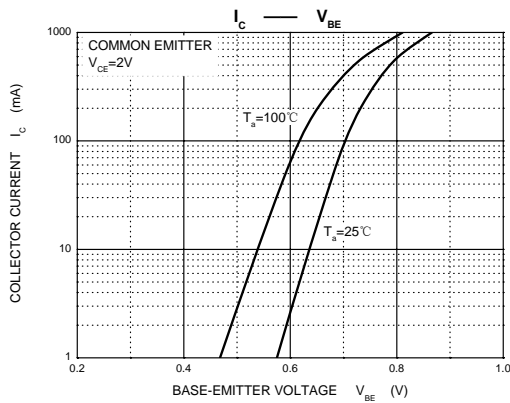
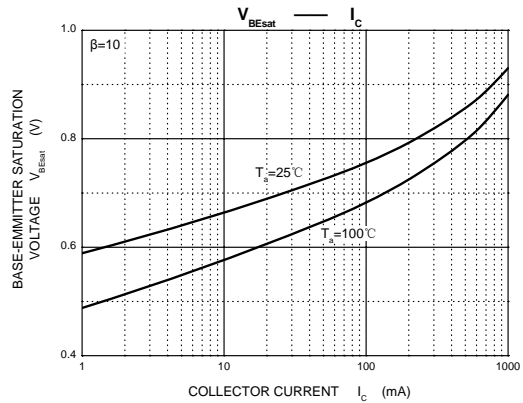
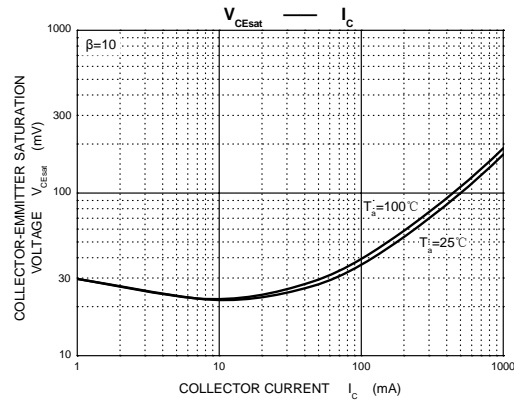
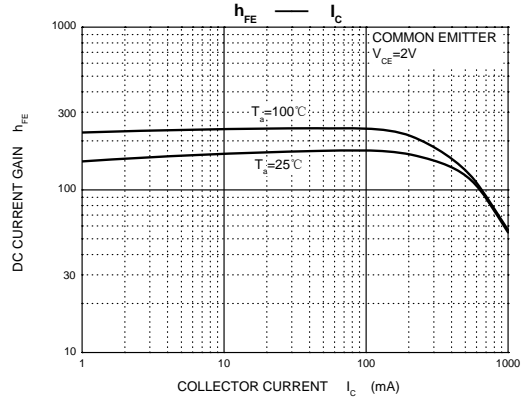
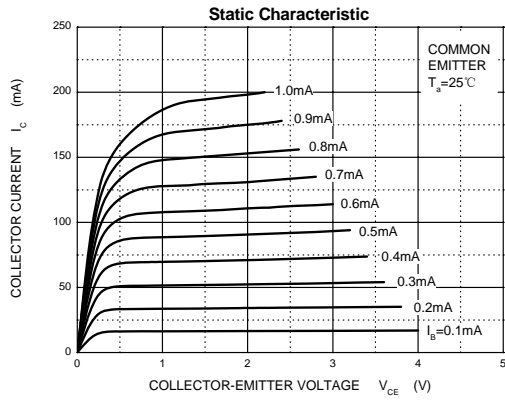

Physical Dimensions

SOT-89

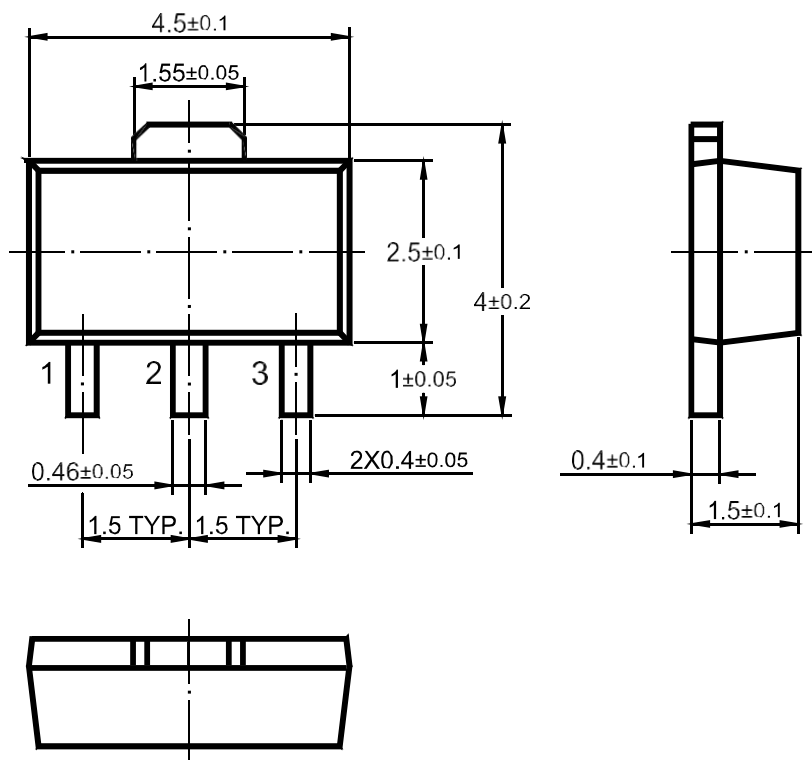

Dimensions in mm

## X-ON Electronics

Largest Supplier of Electrical and Electronic Components

*Click to view similar products for [Bipolar Transistors - BJT category](#):*

*Click to view products by [TWGMC manufacturer](#):*

Other Similar products are found below :

[BC559C](#) [MCH4017-TL-H](#) [MMBT-2369-TR](#) [BC546/116](#) [NJVMJD148T4G](#) [NTE16](#) [NTE195A](#) [IMX9T110](#) [2N4401-A](#) [2N4403](#) [2N6728](#)  
[2SA1419T-TD-H](#) [2SA2126-E](#) [2SB1204S-TL-E](#) [FMC5AT148](#) [2N2369ADCSM](#) [2N2907A](#) [2N3904-NS](#) [2N5769](#) [2SC4618TLN](#) [CPH6501-](#)  
[TL-E](#) [MCH4021-TL-E](#) [Jantx2N5416](#) [US6T6TR](#) [BAX18/A52R](#) [BC556/112](#) [IMZ2AT108](#) [MMST8098T146](#) [UMX21NTR](#) [MCH6102-TL-E](#)  
[TTA1452B,S4X\(S](#) [2N3879](#) [NTE13](#) [NTE282](#) [NTE323](#) [NTE350](#) [NTE81](#) [JANTX2N2920L](#) [JANTX2N3735](#) [JANSR2N2222AUB](#)  
[CMLT3946EG TR](#) [SNSS40600CF8T1G](#) [CMLT3906EG TR](#) [GRP-DATA-JANS2N2907AUB](#) [GRP-DATA-JANS2N2222AUA](#)  
[MMDT3946FL3-7](#) [2N4240](#) [MSB30KH-13](#) [2N2221AUB](#) [2SD1815T-TL-E](#)