

BCX54 THRU BCX56 TRANSISTOR(NPN)

FEATURE

- PNP Complements to BCX51,BCX52,BCX53
- Low Voltage
- High Current

APPLICATIONS

- Driver Stages of Audio Amplifiers

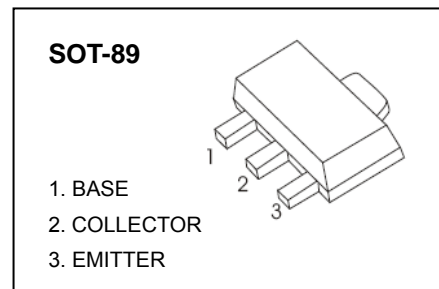

MAXIMUM RATINGS ($T_A=25^{\circ}\text{C}$ unless otherwise noted)

Symbol	Parameter	Value	Unit	
V_{CBO}	Collector-Base Voltage	BCX54	45	V
		BCX55	60	
		BCX56	100	
V_{CEO}	Collector-Emitter Voltage	BCX54	45	V
		BCX55	60	
		BCX56	80	
V_{EBO}	Emitter-Base Voltage	5	V	
I_C	Collector Current	1	A	
P_C	Collector Power Dissipation	500	mW	
$R_{\theta JA}$	Thermal Resistance From Junction To Ambient	250	$^{\circ}\text{C}/\text{W}$	
T_j	Junction Temperature	150	$^{\circ}\text{C}$	
T_{stg}	Storage Temperature	-55~+150	$^{\circ}\text{C}$	

ELECTRICAL CHARACTERISTICS (Ta=25°C unless otherwise specified)

Parameter	Symbol	Test conditions	Min	Typ	Max	Unit
Collector-base breakdown voltage	$V_{(BR)CBO}$	$I_C=100\mu A, I_E=0$	BCX54	45		V
			BCX55	60		
			BCX56	100		
Collector-emitter breakdown voltage	$V_{(BR)CEO^*}$	$I_C=10mA, I_B=0$	BCX54	45		V
			BCX55	60		
			BCX56	80		
Emitter-base breakdown voltage	$V_{(BR)EBO}$	$I_E=100\mu A, I_C=0$	5			V
Collector cut-off current	I_{CBO}	$V_{CB}=30V, I_E=0$			0.1	μA
Emitter cut-off current	I_{EBO}	$V_{EB}=5V, I_C=0$			0.1	μA
DC current gain	$h_{FE(1)^*}$	$V_{CE}=2V, I_C=5mA$	40			
	$h_{FE(2)^*}$	$V_{CE}=2V, I_C=150mA$	63		250	
	$h_{FE(3)^*}$	$V_{CE}=2V, I_C=0.5A$	25			
Collector-emitter saturation voltage	$V_{CE(sat)^*}$	$I_C=0.5A, I_B=50mA$			0.5	V
Base-emitter voltage	V_{BE^*}	$V_{CE}=2V, I_C=0.5A$			1	V
Transition frequency	f_T	$V_{CE}=5V, I_C=10mA, f=100MHz$		130		MHz

CLASSIFICATION OF $h_{FE(2)}$

RANK	BCX54	BCX54-10	BCX54-16
	BCX55	BCX55-10	BCX55-16
	BCX56	BCX56-10	BCX56-16
RANGE	63 - 250	63 - 160	100 - 250

TYPICAL CHARACTERISTICS

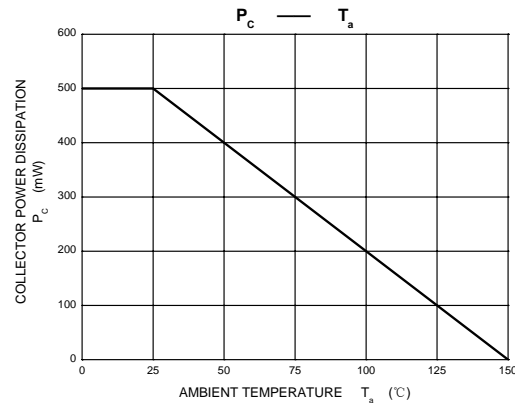
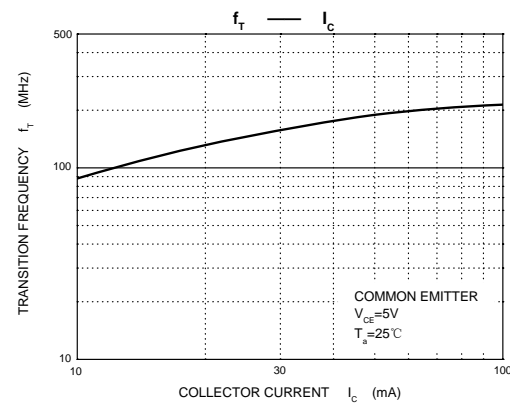
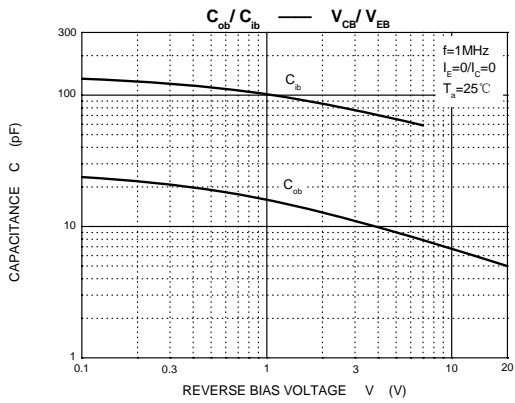
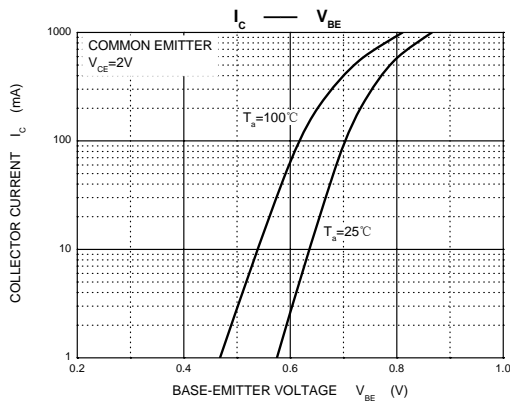
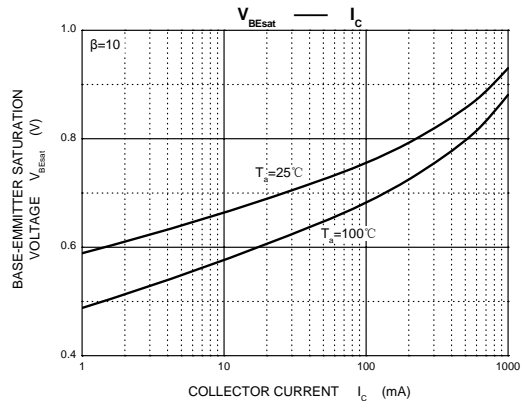
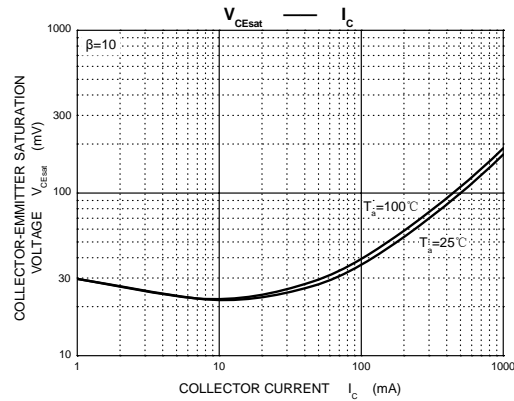
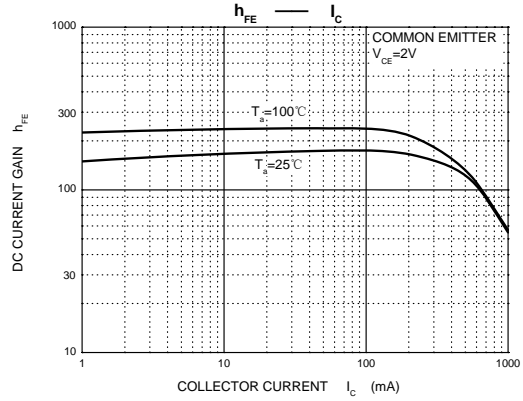
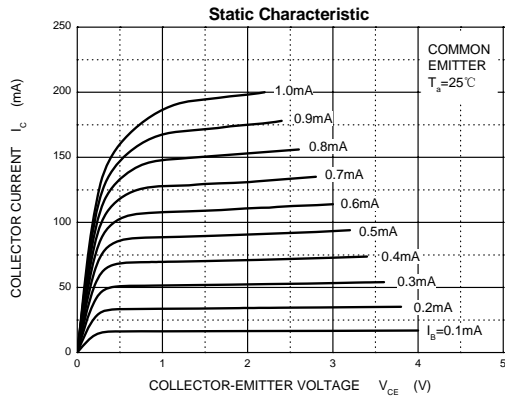

Physical Dimensions

SOT-89

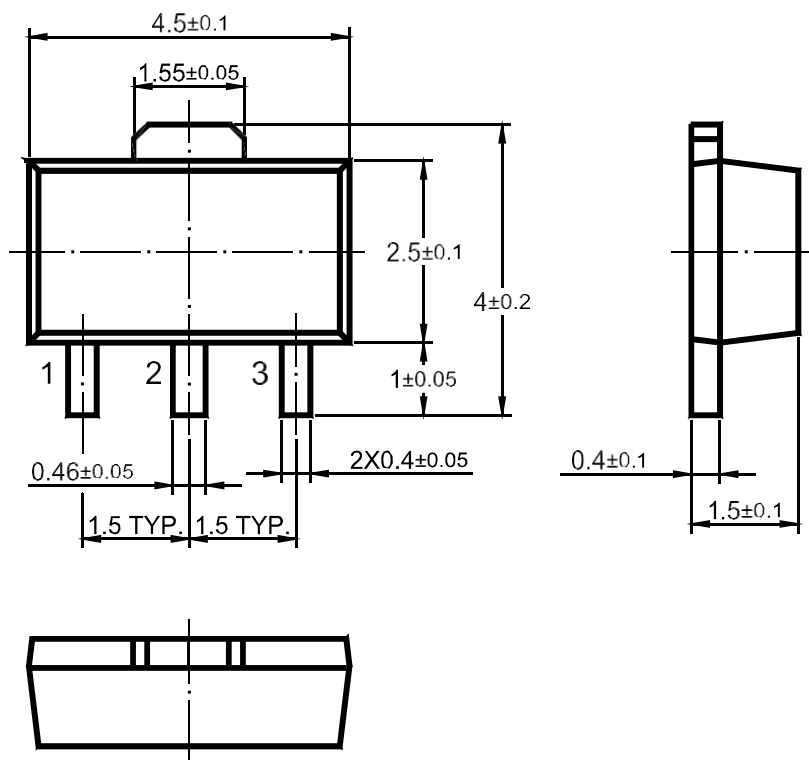

Dimensions in mm

X-ON Electronics

Largest Supplier of Electrical and Electronic Components

Click to view similar products for [Bipolar Transistors - BJT category](#):

Click to view products by [TWGMC manufacturer](#):

Other Similar products are found below :

[619691C](#) [MCH4017-TL-H](#) [MMBT-2369-TR](#) [BC546/116](#) [BC557/116](#) [BSW67A](#) [NJVMJD148T4G](#) [NTE123AP-10](#) [NTE153MCP](#) [NTE16](#)
[NTE195A](#) [NTE92](#) [2N4401-A](#) [2N6728](#) [2SA1419T-TD-H](#) [2SA2126-E](#) [2SB1204S-TL-E](#) [2SC2712S-GR,LF](#) [SP000011176](#) [2N2907A](#) [2N3904-](#)
[NS](#) [2N5769](#) [2SC2412KT146S](#) [CPH6501-TL-E](#) [MCH4021-TL-E](#) [MJE340](#) [Jantx2N5416](#) [US6T6TR](#) [NJL0281DG](#) [732314D](#) [CPH3121-TL-E](#)
[CPH6021-TL-H](#) [873787E](#) [IMZ2AT108](#) [MMST8098T146](#) [UMX21NTR](#) [MCH6102-TL-E](#) [NJL0302DG](#) [30A02MH-TL-E](#) [NTE13](#) [NTE26](#)
[NTE282](#) [NTE323](#) [NTE350](#) [NTE81](#) [STX83003-AP](#) [JANTX2N2920L](#) [JANSR2N2222AUB](#) [CMLT3946EG TR](#) [2SA1371D-AE](#)