

SURFACE MOUNT SCHOTTKY BARRIER RECTIFIER

PINNING

PIN	DESCRIPTION
1	Cathode
2	Anode

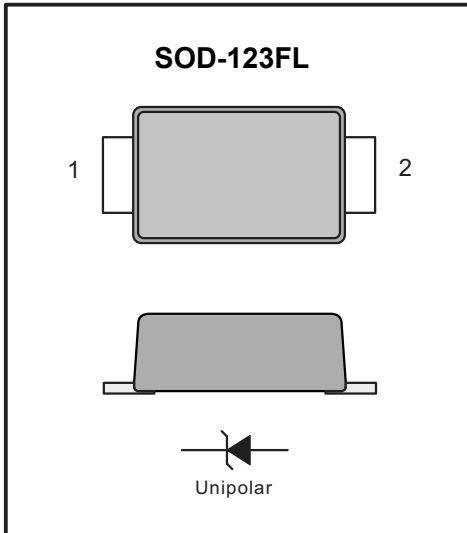

Features

- ◆ The plastic package carries Underwriters Laboratory Flammability Classification 94V-0
- ◆ For surface mounted applications
- ◆ Metal silicon junction, majority carrier conduction
- ◆ Low power loss, high efficiency
- ◆ Built-in strain relief, ideal for automated placement
- ◆ High forward surge current capability
- ◆ High temperature soldering guaranteed: 250 °C/10 seconds at terminals

Mechanical Data

- ◆ Case: JEDEC SOD-123FL molded plastic body
- ◆ Terminals: Solderable per MIL-STD-750, Method 2026
- ◆ Polarity: Color band denotes cathode end Mounting
- ◆ Position: Any
- ◆ Weight : 0.0007 ounce, 0.02 grams

Maximum Ratings And Electrical Characteristics

Ratings at 25°C ambient temperature unless otherwise specified.

Single phase half-wave 60Hz, resistive or inductive load, for capacitive load current derate by 20%.

Parameter	SYMBOLS	DSK22	DSK24	DSK25	DSK26	DSK28	DSK210	DSK215	DSK220	UNITS
		K22	K24	K25	K26	K28	K210	K215	K220	
Maximum repetitive peak reverse voltage	V _{RRM}	20	40	50	60	80	100	150	200	V
Maximum RMS voltage	V _{RMS}	14	28	35	42	56	70	105	140	V
Maximum DC blocking voltage	V _{DC}	20	40	50	60	80	100	150	200	V
Maximum average forward rectified current at TL (see fig.1)	I <sub(av)< sub=""></sub(av)<>	2.0								A
Peak forward surge current 8.3ms single half sine-wave superimposed on rated load (JEDEC Method)	I _{FSM}	40								A
Maximum instantaneous forward voltage at 2.0A	V _F	0.55		0.70		0.85			V	
Maximum DC reverse current at rated DC blocking voltage T _A =25°C T _A =125°C	I _R	10.0				5.0				mA
Typical junction capacitance (NOTE 1)	C _J	220		80						
Typical thermal resistance (NOTE 2)	R _{θJA}	85.0								°C/W
Operating junction temperature range	T _J	-55 to +125								°C
Storage temperature range	T _{STG}	-55 to +150								°C

Note: 1. Measured at 1MHz and applied reverse voltage of 4.0V D.C.

Typical Characteristics

Fig.1 Forward Current Derating Curve

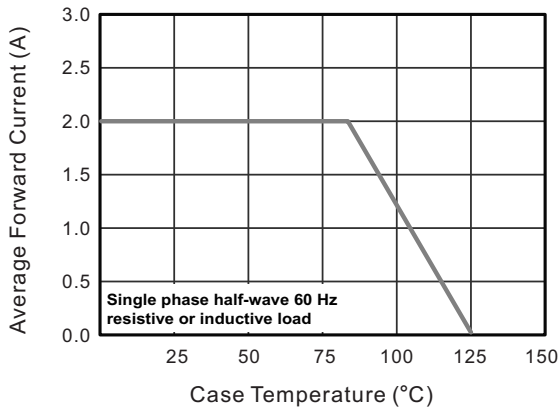

Fig.2 Typical Reverse Characteristics

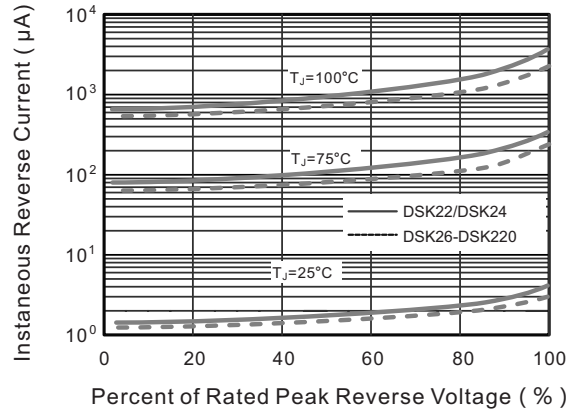

Fig.3 Typical Forward Characteristic

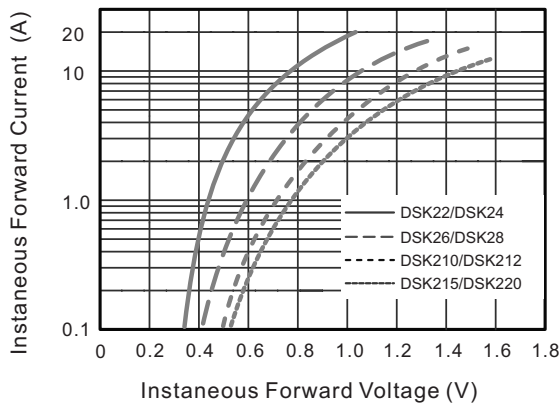

Fig.4 Typical Junction Capacitance

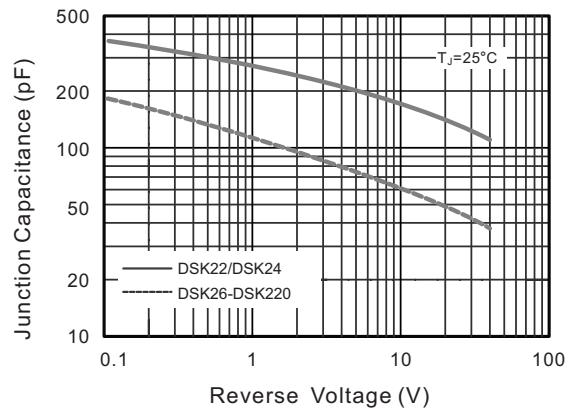

Fig.5 Maximum Non-Repetitive Peak Forward Surge Current

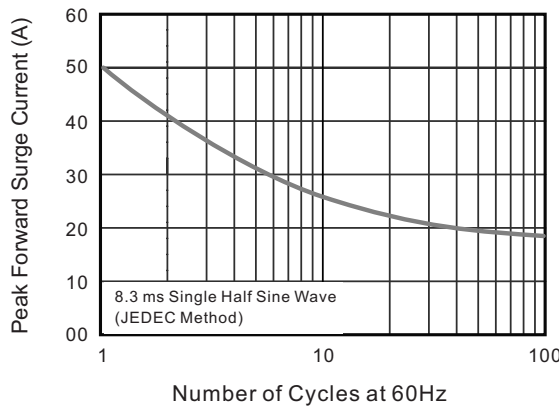
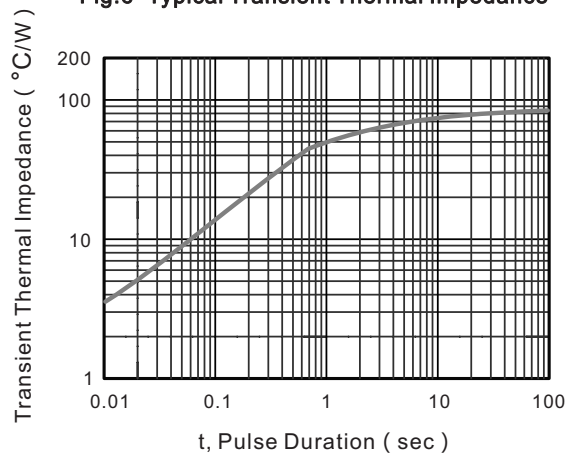

Fig.6- Typical Transient Thermal Impedance



PACKAGE OUTLINE

Plastic surface mounted package; 2 leads

SOD-123FL

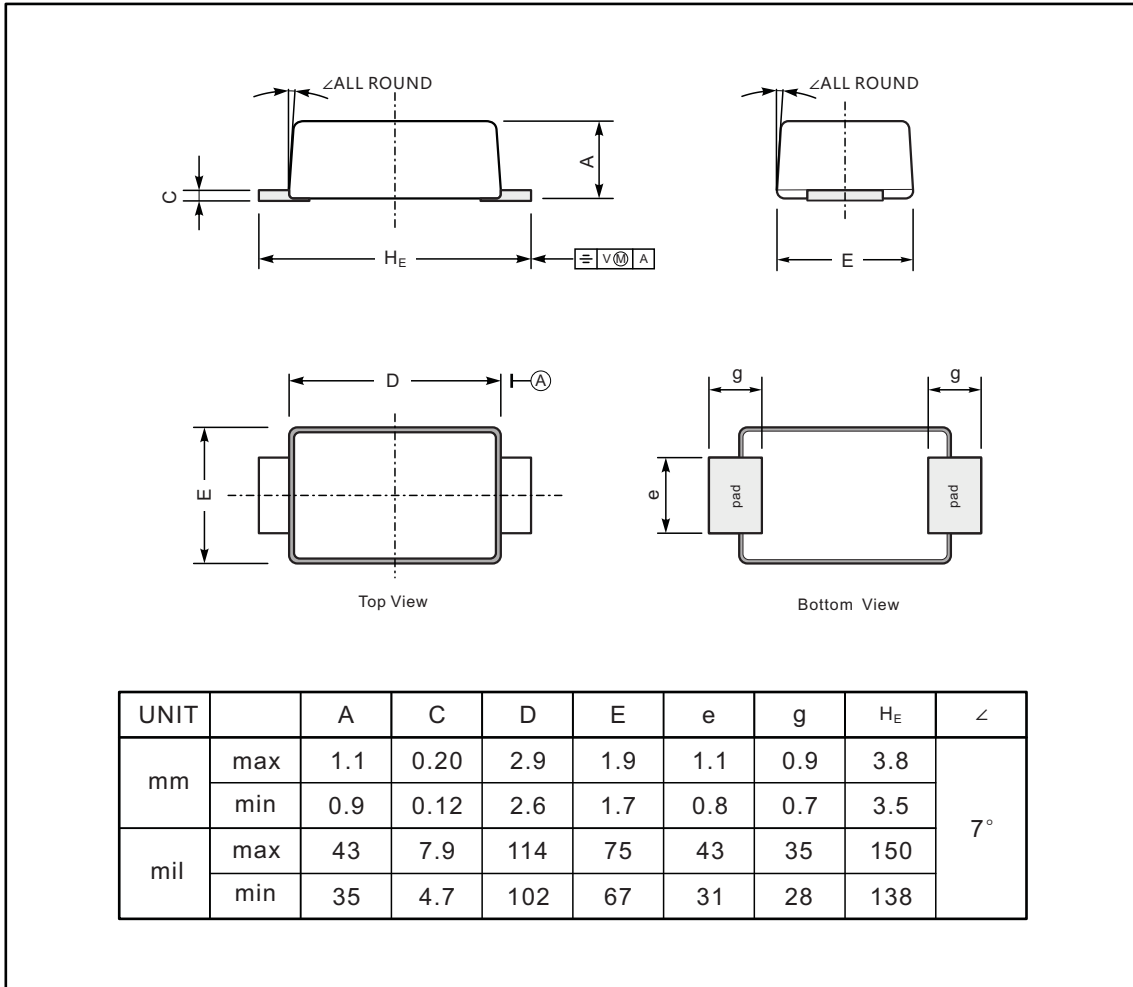

The recommended mounting pad size

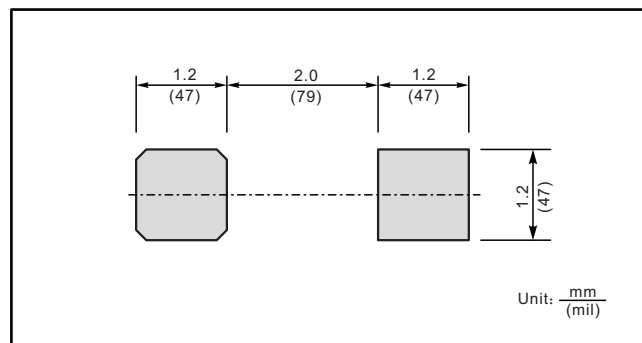

X-ON Electronics

Largest Supplier of Electrical and Electronic Components

Click to view similar products for [Schottky Diodes & Rectifiers](#) category:

Click to view products by [TWGMC](#) manufacturer:

Other Similar products are found below :

[CUS06\(TE85L,Q,M\)](#) [MA4E2039](#) [D1FH3-5063](#) [MBR0530L-TP](#) [MBR10100CT-BP](#) [MBR30H100MFST1G](#) [MMBD301M3T5G](#) [PMAD1103-LF](#) [PMAD1108-LF](#) [RB160M-50TR](#) [RB520S-30](#) [RB551V-30](#) [DD350N18K](#) [DZ435N40K](#) [DZ600N16K](#) [BAS16E6433HTMA1](#) [BAS 3010S-02LRH E6327](#) [BAT 54-02LRH E6327](#) [IDL02G65C5XUMA1](#) [NSR05F40QNXT5G](#) [NSVR05F40NXT5G](#) [JANS1N6640](#) [SB07-03C-TB-H](#) [SB1003M3-TL-W](#) [SBAT54CWT1G](#) [SBM30-03-TR-E](#) [SBS818-TL-E](#) [SK32A-LTP](#) [SK33A-TP](#) [SK34A-TP](#) [SK34B-TP](#) [SMD1200PL-TP](#) [ACDBN160-HF](#) [SS3003CH-TL-E](#) [STPS30S45CW](#) [PDS3100Q-7](#) [GA01SHT18](#) [CRS10I30A\(TE85L,QM\)](#) [MBR1240MFST1G](#) [MBRB30H30CT-1G](#) [BAS28E6433HTMA1](#) [BAS 70-02L E6327](#) [HSB123JTR-E](#) [JANTX1N5712-1](#) [VS-STPS40L45CW-N3](#) [DD350N12K](#) [SB007-03C-TB-E](#) [SB10015M-TL-E](#) [SB1003M3-TL-E](#) [SK110-LTP](#)