

Features

- ◆ Ultra low leakage: nA level
- ◆ Low operating voltage: 12V
- ◆ Low clamping voltage
- ◆ 2-pin leadless package
- ◆ Complies with following standards:
 - IEC 61000-4-2 (ESD) immunity test
 - Air discharge: $\pm 30\text{kV}$
 - Contact discharge: $\pm 30\text{kV}$
 - IEC61000-4-5 (Lightning) 10A (8/20 μs)
- ◆ RoHS Compliant
 - Package: SOD-523

Description

The ESDJ12UL0S5 is a Uni-directional TVS diode, utilizing leading monolithic silicon technology to provide fast response time and low ESD clamping voltage, making this device an ideal solution for protecting voltage sensitive data and power line. The ESDJ12UL0S5 complies with the IEC 61000-4-2 (ESD) standard with $\pm 30\text{ kV}$ air and $\pm 30\text{ kV}$ contact discharge. It is assembled into an ultra-small SOD-523 lead-free package. The small size and high ESD surge protection make ESDJ12UL0S5 an ideal choice to protect cell phone, digital cameras, audio players and many other portable applications.

Circuit Diagram

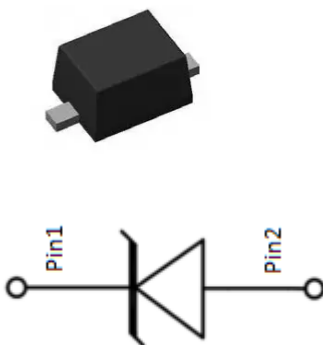

Applications

- ◆ Cellular Handsets and Accessories
- ◆ Personal Digital Assistants
- ◆ Notebooks and Handhelds
- ◆ Portable Instrumentation
- ◆ Digital Cameras
- ◆ Peripherals
- ◆ Audio Players
- ◆ Keypads, Side Keys, LCD Displays

Absolute Maximum Ratings : ($T_c=25^{\circ}\text{C}$ unless otherwise noted)

Parameter	Symbol	Value	Unit
Peak Pulse Power (8/20 μs)	Ppk	240	W
Peak Pulse Current (8/20 μs)	IPP	10	A
ESD per IEC 61000-4-2 (Air)	VESD	± 30	kV
ESD per IEC 61000-4-2 (Contact)		± 30	
Operating Temperature Range	TJ	-55 to +125	$^{\circ}\text{C}$
Storage Temperature Range	Tstg	-55 to +150	$^{\circ}\text{C}$

Electrical Characteristics : ($T_c=25^{\circ}\text{C}$ unless otherwise noted)

Parameter	Symbol	Test Condition	Min	Typ	Max	Unit
Reverse Working Voltage	V_{RWM}				12.0	V
Breakdown Voltage	V_{BR}	$I_T = 1\text{mA}$	13.5	15.3	16.5	V
Reverse Leakage Current	I_R	$V_{RWM} = 12\text{V}$			0.2	μA
Clamping Voltage	V_C	$I_{PP} = 1\text{A}$ (8 / 20 μs pulse)			18.0	V
Clamping Voltage	V_C	$I_{PP} = 10\text{A}$ (8 / 20 μs pulse)			24.0	V
Junction Capacitance	C_J	$V_R = 0\text{V}$, $f = 1\text{MHz}$		46		pF

Portion Electronics Parameter

Symbol	Parameter
V_{RWM}	Peak Reverse Working Voltage
I_R	Reverse Leakage Current @ V_{RWM}
V_{BR}	Breakdown Voltage @ I_T
I_T	Test Current
I_{PP}	Maximum Reverse Peak Pulse Current
V_C	Clamping Voltage @ I_{PP}

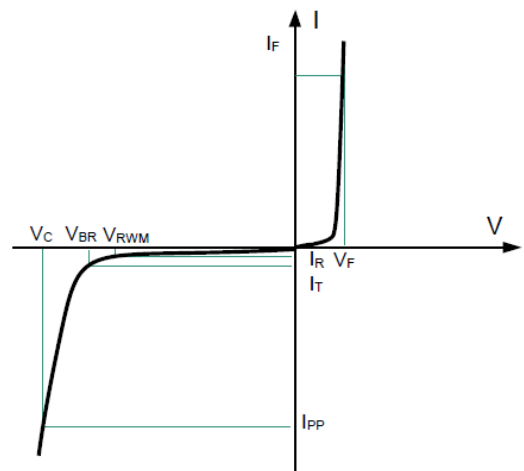

Typical Characteristics: (T_c=25°C unless otherwise noted)

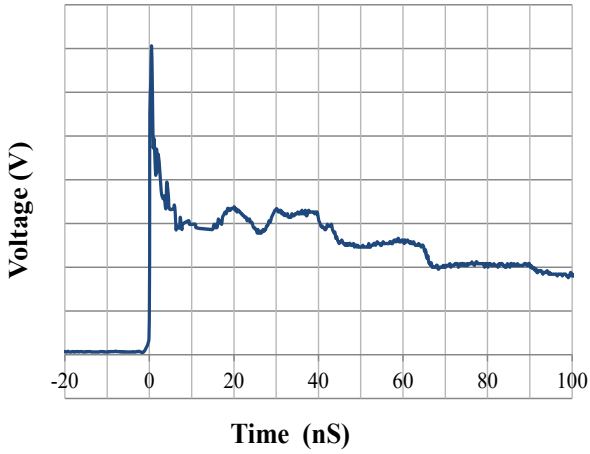

IEC61000-4-2 Pulse Waveform

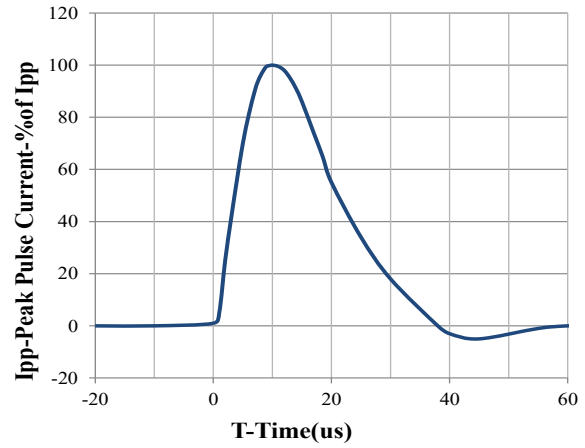

8 / 20us Pulse Waveform

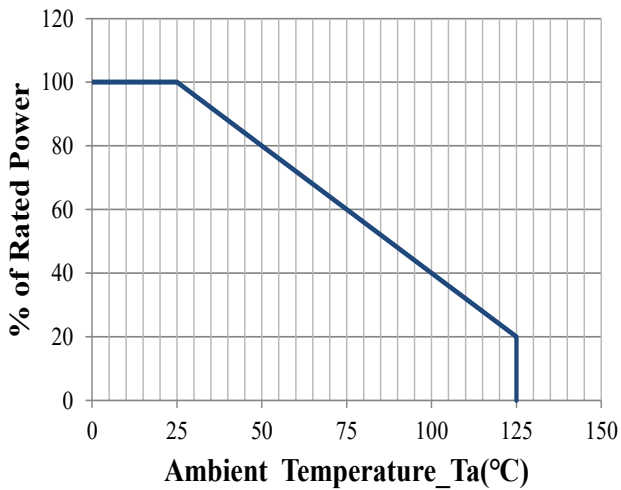

Power Derating Curve

SOD-523 Package Outline Drawing

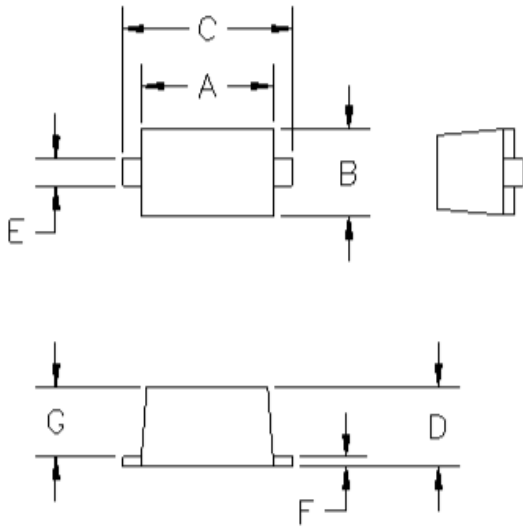

DIMENSIONS					
DIM ^N	INCHES		MM		NOTE
	. MIN	MAX	MIN	MAX	
A	.043	.051	1.10	1.30	—
B	.028	.035	0.70	0.90	—
C	.059	.067	1.50	1.70	—
D	.020	.028	0.50	0.70	—
E	.010	.014	0.25	0.35	—
F	.004	.008	0.10	0.20	—
G	.020	.028	0.50	0.70	—

Suggested Land Pattern

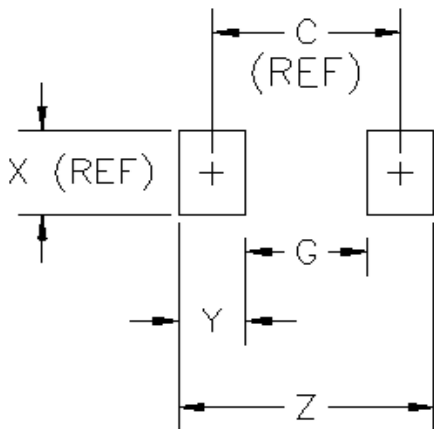

DIMENSIONS					
DIM ^N	INCHES		MM		NOTE
	MIN	MAX	MIN	MAX	
C	—	.067	—	1.70	REF
G	—	.043	—	1.10	—
X	—	.031	—	0.80	REF
Y	—	.024	—	0.60	—
Z	—	.091	--	2.30	—

Soldering Parameters

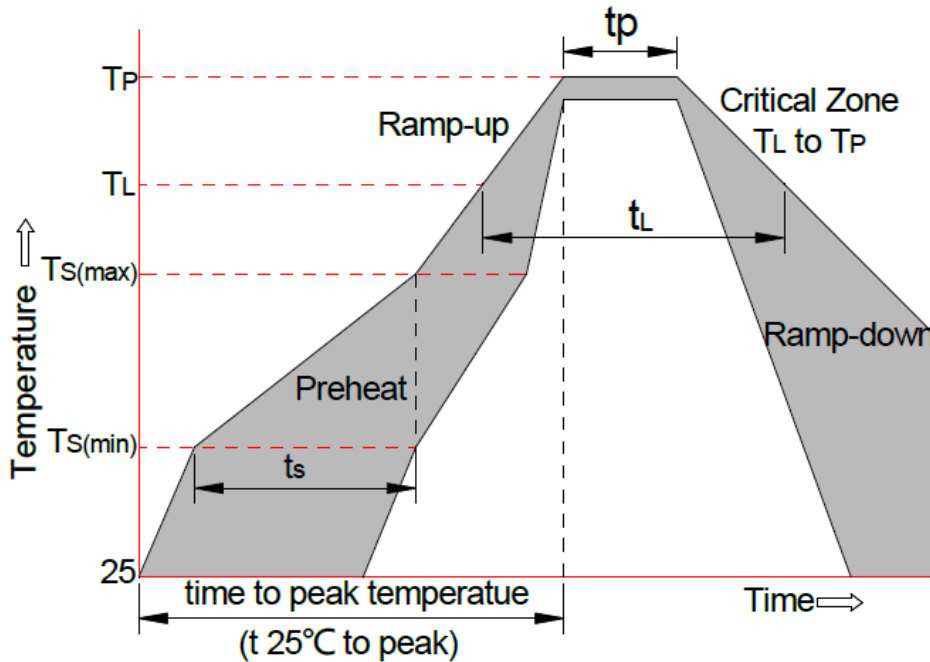

Reflow Condition		Pb-Free Assembly
Pre-heat	-Temperature Min (Ts (min))	+150°C
	-Temperature Max (Ts (max))	+200°C
	-Time (Min to Max) (ts)	60-180 secs
Average ramp up rate(Liquid us Temp (TL) to peak)		3°C/sec. Max
Ts (max) to TL-Ramp-up Rate		3°C/sec. Max
Reflow	-Temperature (TL) (Liquid us)	+217°C
	-Temperature (tL)	60-150 secs
Peak Temp (Tp)		+260(+0/-5)°C
Time within 5°C of actual Peak Temp (tp)		30 secs. Max
Ramp-down Rate		6 °C/secs. Max
xTime 25°C to Peak Temp (TP)		8 min. Max
Do not exceed		+260°C

X-ON Electronics

Largest Supplier of Electrical and Electronic Components

Click to view similar products for [ESD Suppressors / TVS Diodes](#) category:

Click to view products by [TWGMC](#) manufacturer:

Other Similar products are found below :

[60KS200C](#) [D18V0L1B2LP-7B](#) [D5V0F4U5P5-7](#) [NTE4902](#) [P4KE27CA](#) [P6KE11CA](#) [P6KE39CA-TP](#) [P6KE8.2A](#) [JANTX1N6053A](#)
[SA110CA](#) [SA60CA](#) [SA64CA](#) [SMBJ12CATR](#) [SMBJ33CATR](#) [SMBJ8.0A](#) [ESD105-B1-02EL E6327](#) [ESD112-B1-02EL E6327](#)
[ESD5V0L1B02VH6327XTSA1](#) [ESD7451N2T5G](#) [19180-510](#) [CPDT-5V0USP-HF](#) [3.0SMCJ33CA-F](#) [3.0SMCJ36A-F](#) [HSPC16701B02TP](#)
[JANTX1N6126A](#) [JANTX1N6465](#) [USB50805e3/TR7](#) [D3V3Q1B2DLP3-7](#) [D55V0M1B2WS-7](#) [DRTR5V0U4SL-7](#) [SCM1293A-04SO](#)
[ESD200-B1-CSP0201 E6327](#) [SM12-7](#) [SM1605E3/TR13](#) [SMLJ45CA-TP](#) [CEN955 W/DATA](#) [82350120560](#) [VESD12A1A-HD1-GS08](#)
[CPDUR5V0R-HF](#) [CPDQC5V0U-HF](#) [CPDQC5V0USP-HF](#) [CPDQC5V0-HF](#) [D1213A-01LP4-7B](#) [ESD101-B1-02EL E6327](#) [824500181](#)
[MMAD1108/TR13](#) [5KP100A](#) [5KP15A](#) [5KP18A](#) [5KP48A](#)