

MMBT3906 TRANSISTOR (PNP)
FEATURES

- Complementary Type The NPN Transistor
- MMBT3904 is Recommended
- Epitaxial Planar Die Construction

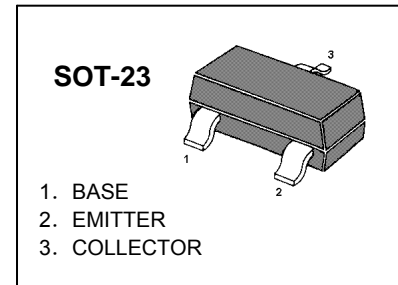

MARKING: 2A
MAXIMUM RATINGS (T_a=25°C unless otherwise noted)

Symbol	Parameter	Value	Unit
V _{CBO}	Collector-Base Voltage	-40	V
V _{CEO}	Collector-Emitter Voltage	-40	V
V _{EBO}	Emitter-Base Voltage	-5	V
I _C	Collector Current	-200	mA
P _C	Total Device Dissipation	200	mW
R _{θJA}	Thermal Resistance Junction to Ambient	625	°C/W
T _J	Junction Temperature	150	°C
T _{stg}	Storage Temperature	-55 ~ +150	°C

ELECTRICAL CHARACTERISTICS (T_a=25°C unless otherwise specified)

Parameter	Symbol	Test conditions	Min	Max	Unit
Collector-base breakdown voltage	V _{(BR)CBO}	I _C =-10μA, I _E =0	-40		V
Collector-emitter breakdown voltage	V _{(BR)CEO}	I _C =-1mA, I _B =0	-40		V
Emitter-base breakdown voltage	V _{(BR)EBO}	I _E =-10μA, I _C =0	-5		V
Collector cut-off current	I _{CBO}	V _{CB} =-40V, I _E =0		-0.1	μA
Collector cut-off current	I _{CEX}	V _{CE} =-30V, V _{BE(off)} =-3V		-50	nA
Emitter cut-off current	I _{EBO}	V _{EB} =-5V, I _C =0		-0.1	μA
DC current gain	h _{FE(1)}	V _{CE} =-1V, I _C =-10mA	100	300	
	h _{FE(2)}	V _{CE} =-1V, I _C =-50mA	60		
	h _{FE(3)}	V _{CE} =-1V, I _C =-100mA	30		
Collector-emitter saturation voltage	V _{CE(sat)}	I _C =-50mA, I _B =-5mA		-0.3	V
Base-emitter saturation voltage	V _{BE(sat)}	I _C =-50mA, I _B =-5mA		-0.95	V
Transition frequency	f _T	V _{CE} =-20V, I _C =-10mA, f=100MHz	300		MHz
Delay Time	t _d	V _{CC} =-3V, V _{BE} =-0.5V		35	nS
Rise Time	t _r	I _C =-10mA, I _{B1} =-I _{B2} =-1mA		35	nS
Storage Time	t _s	V _{CC} =-3V, I _C =-10mA,		225	nS
Fall Time	t _f	I _{B1} =-I _{B2} =-1mA		75	nS

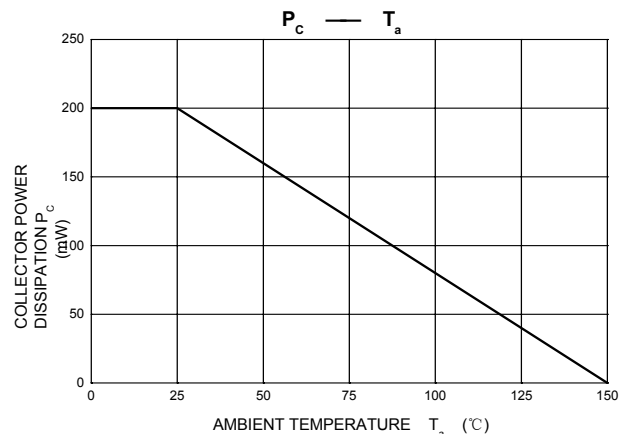
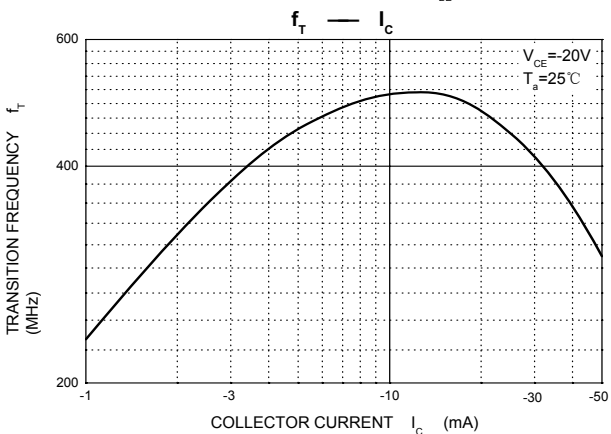
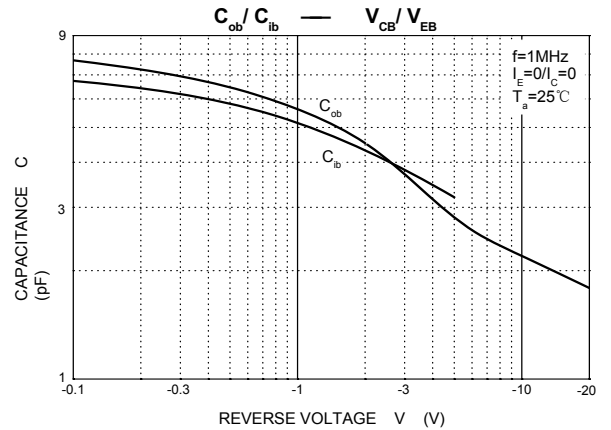
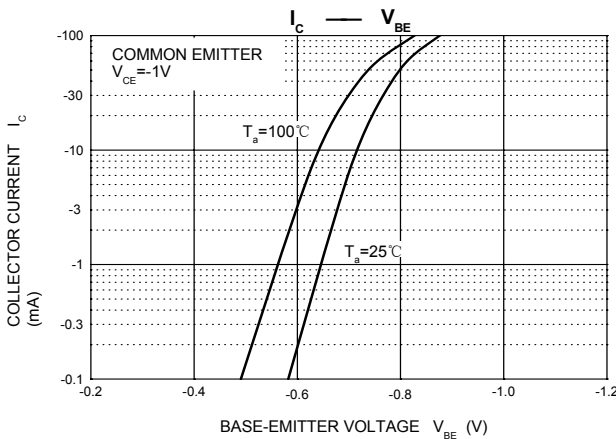
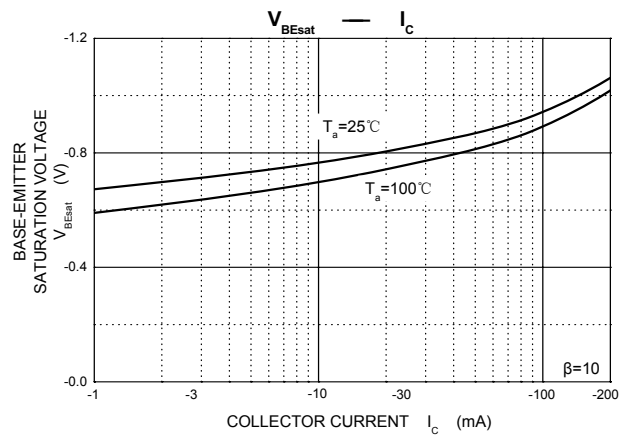
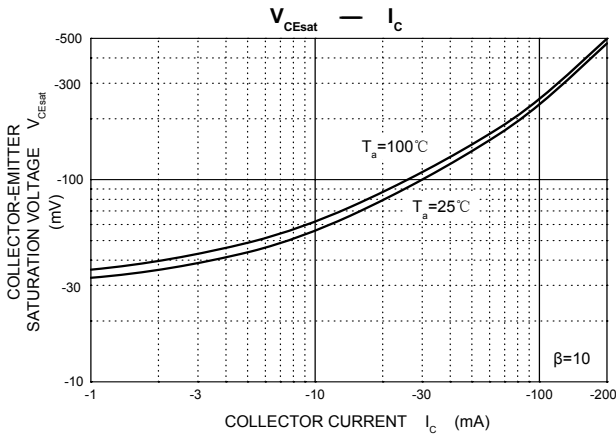
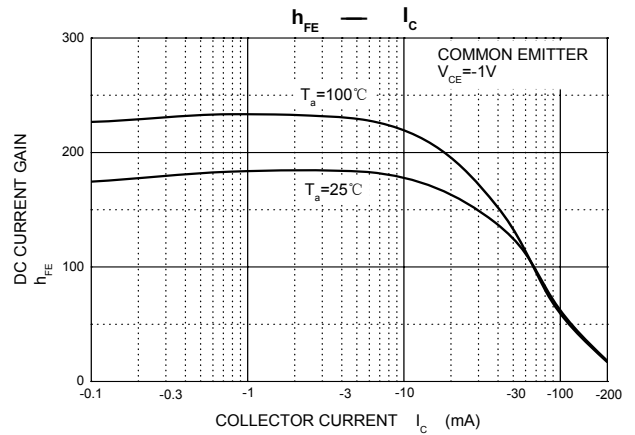
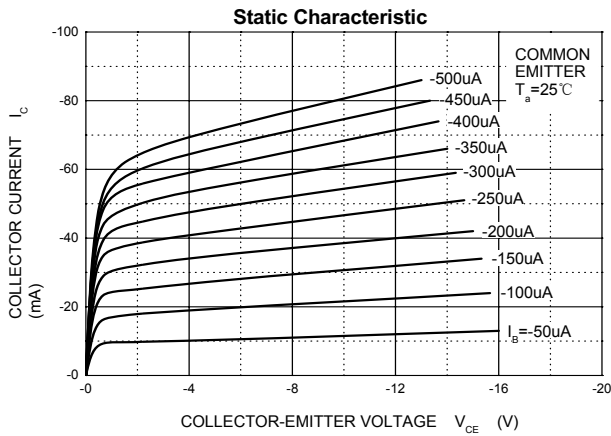
Typical Characteristics



PACKAGE OUTLINE

Plastic surface mounted package; 3 leads

SOT-23

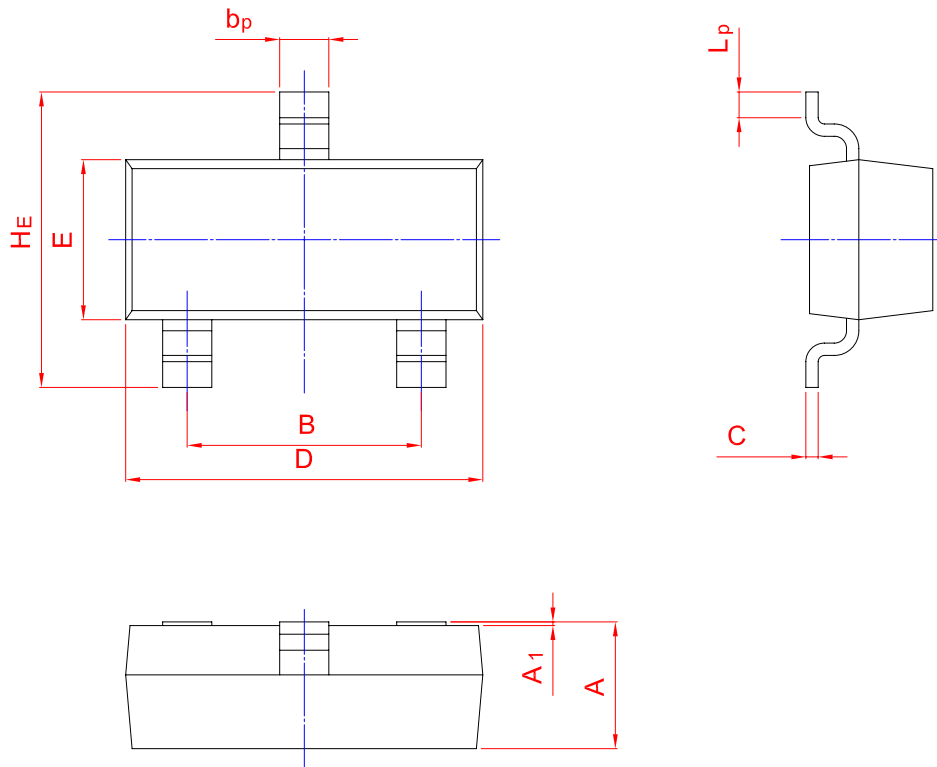

UNIT	A	B	b_p	C	D	E	H_E	A_1	L_p
mm	1.40	2.04	0.50	0.19	3.10	1.65	3.00	0.100	0.50
	0.95	1.78	0.35	0.08	2.70	1.20	2.20	0.013	0.20

X-ON Electronics

Largest Supplier of Electrical and Electronic Components

Click to view similar products for [Bipolar Transistors - BJT category](#):

Click to view products by [TWGMC manufacturer](#):

Other Similar products are found below :

[619691C](#) [MCH4017-TL-H](#) [MJ15024/WS](#) [MJ15025/WS](#) [BC546/116](#) [BC556/FSC](#) [BC557/116](#) [BSW67A](#) [HN7G01FU-A\(T5L,F,T](#)
[NJVMJD148T4G](#) [NSVMMBT6520LT1G](#) [NTE187A](#) [NTE195A](#) [NTE2302](#) [NTE2330](#) [NTE2353](#) [NTE316](#) [IMX9T110](#) [NTE63](#) [NTE65](#)
[C4460](#) [SBC846BLT3G](#) [2SA1419T-TD-H](#) [2SA1721-O\(TE85L,F\)](#) [2SA1727TLP](#) [2SA2126-E](#) [2SB1202T-TL-E](#) [2SB1204S-TL-E](#) [2SC5488A-](#)
[TL-H](#) [2SD2150T100R](#) [SP000011176](#) [FMC5AT148](#) [2N2369ADCSM](#) [2SB1202S-TL-E](#) [2SC2412KT146S](#) [2SC4618TLN](#) [2SC5490A-TL-H](#)
[2SD1816S-TL-E](#) [2SD1816T-TL-E](#) [CMXT2207 TR](#) [CPH6501-TL-E](#) [MCH4021-TL-E](#) [BC557B](#) [TTC012\(Q\)](#) [BULD128DT4](#) [JANTX2N3810](#)
[Jantx2N5416](#) [US6T6TR](#) [KSF350](#) [068071B](#)