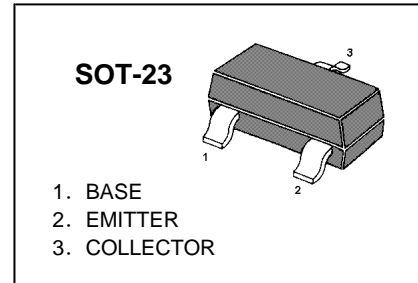

SS8550 TRANSISTOR (PNP)
FEATURES

Complimentary to SS8050

MARKING: Y2

MAXIMUM RATINGS ($T_A=25^{\circ}\text{C}$ unless otherwise noted)

Symbol	Parameter	Value	Units
V_{CB0}	Collector-Base Voltage	-40	V
V_{CE0}	Collector-Emitter Voltage	-25	V
V_{EBO}	Emitter-Base Voltage	-5	V
I_C	Collector Current -Continuous	-1.5	A
P_C	Collector Power Dissipation	0.3	W
T_j	Junction Temperature	150	$^{\circ}\text{C}$
T_{stg}	Storage Temperature	-55-150	$^{\circ}\text{C}$

ELECTRICAL CHARACTERISTICS ($T_{amb}=25^{\circ}\text{C}$ unless otherwise specified)

Parameter	Symbol	Test conditions	MIN	MAX	UNIT
Collector-base breakdown voltage	$V_{(BR)CBO}$	$I_C=-100\mu\text{A}$, $I_E=0$	-40		V
Collector-emitter breakdown voltage	$V_{(BR)CEO}$	$I_C=-0.1\text{mA}$, $I_B=0$	-25		V
Emitter-base breakdown voltage	$V_{(BR)EBO}$	$I_E=-100\mu\text{A}$, $I_C=0$	-5		V
Collector cut-off current	I_{CBO}	$V_{CB}=-40\text{V}$, $I_E=0$		-0.1	μA
Collector cut-off current	I_{CEO}	$V_{CE}=-20\text{V}$, $I_B=0$		-0.1	μA
Emitter cut-off current	I_{EBO}	$V_{EB}=-5\text{V}$, $I_C=0$		-0.1	μA
DC current gain	$h_{FE(1)}$	$V_{CE}=-1\text{V}$, $I_C=-100\text{mA}$	200	350	
	$h_{FE(2)}$	$V_{CE}=-1\text{V}$, $I_C=-800\text{mA}$	40		
Collector-emitter saturation voltage	$V_{CE(sat)}$	$I_C=-800\text{mA}$, $I_B=-80\text{mA}$		-0.5	V
Base-emitter saturation voltage	$V_{BE(sat)}$	$I_C=-800\text{mA}$, $I_B=-80\text{mA}$		-1.2	V
Base-emitter on voltage	$V_{BE(on)}$	$I_C=-1\text{V}$, $V_{CE}=-10\text{mA}$		-1	V
Base-emitter positive favor voltage	V_{BEF}	$I_B=-1\text{A}$		-1.55	V
Transition frequency	f_T	$V_{CE}=-10\text{V}$, $I_C=-50\text{mA}$ $f=30\text{MHz}$	100		MHz
output capacitance	C_{ob}	$(V_{CB}=-10\text{V}, I_E=0, f=1\text{MHz})$		20	pF

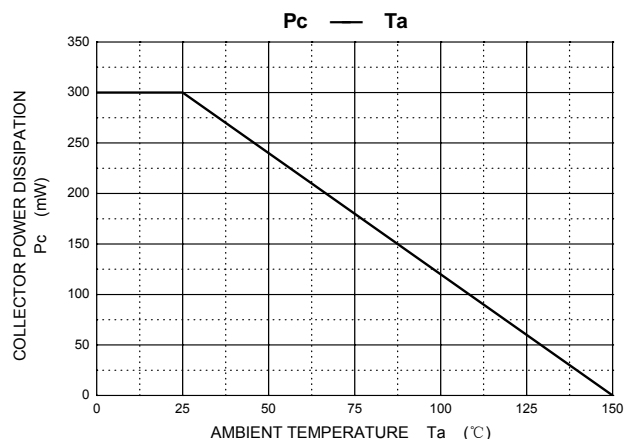
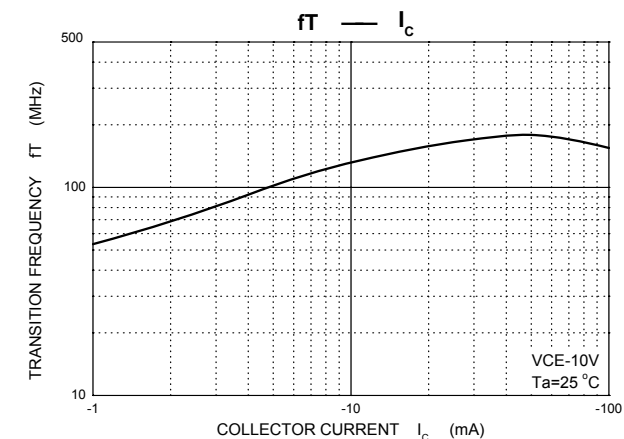
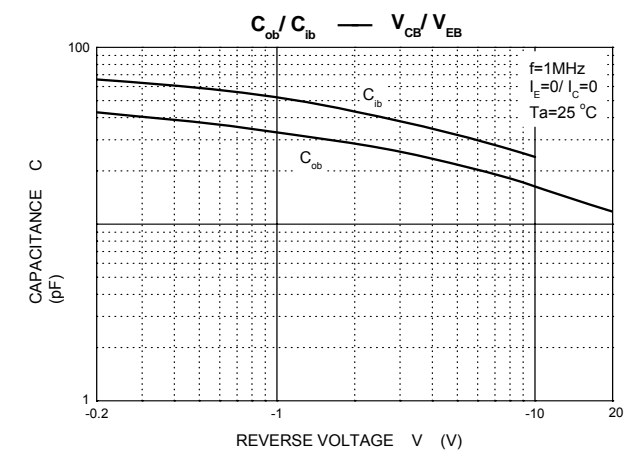
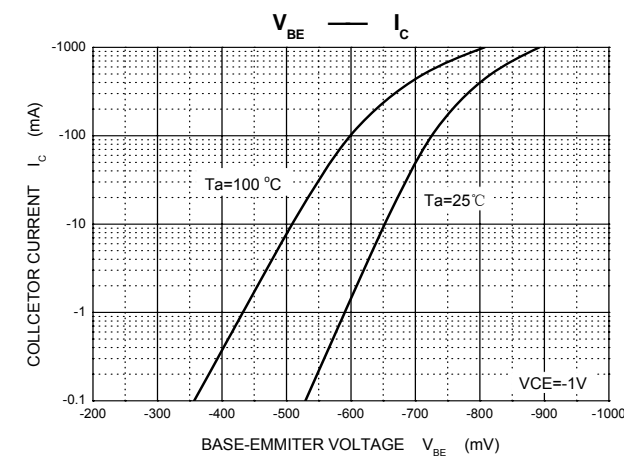
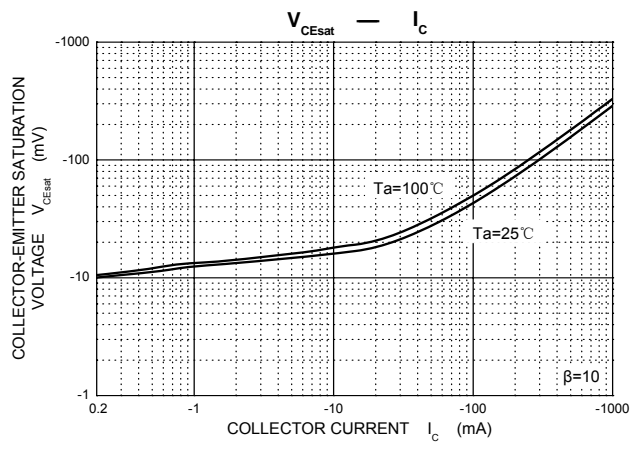
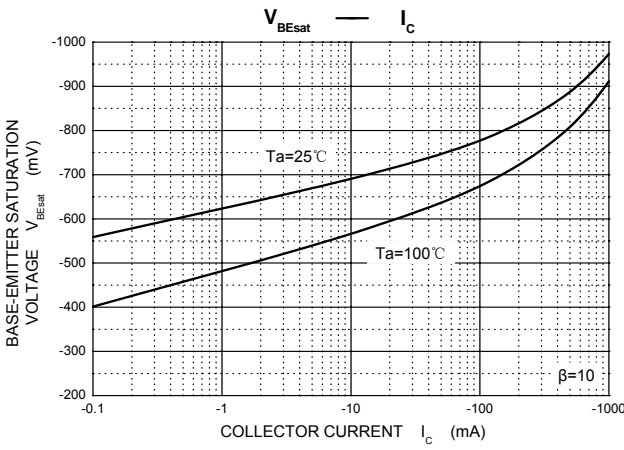
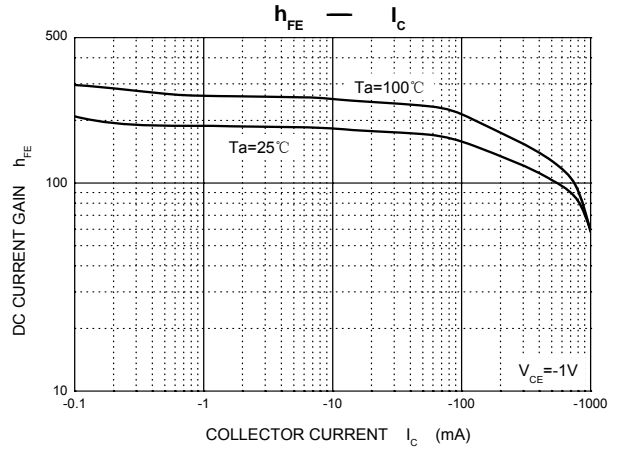
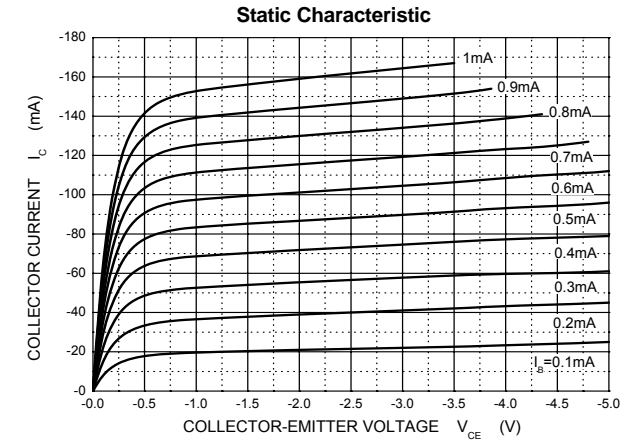
Typical Characteristics



PACKAGE OUTLINE

Plastic surface mounted package; 3 leads

SOT-23

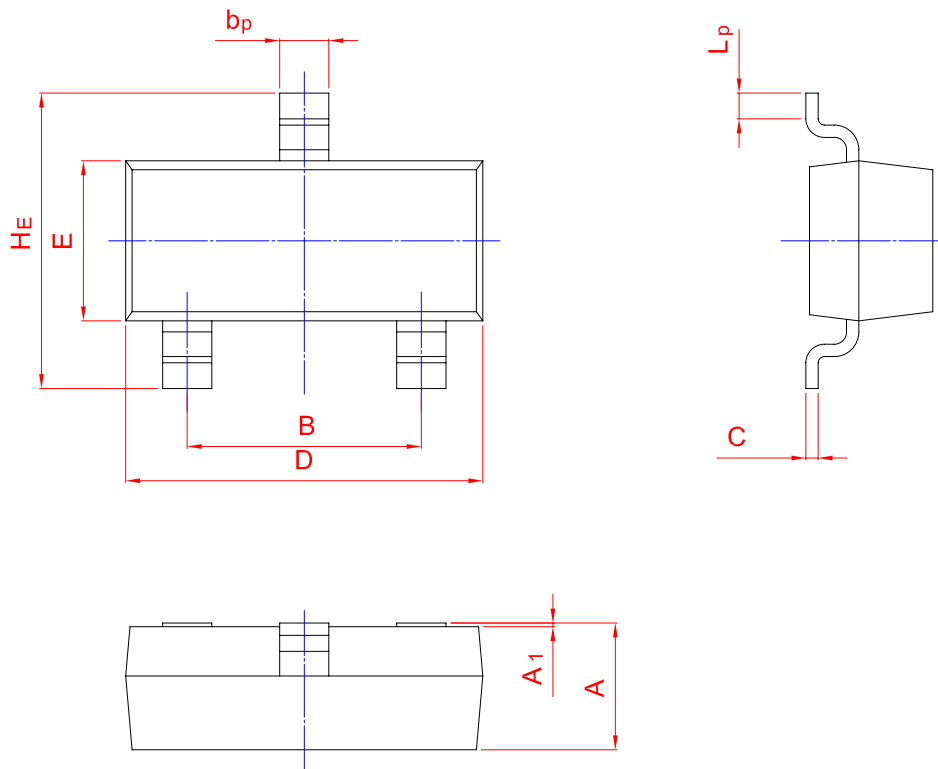
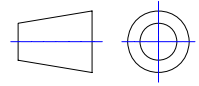

UNIT	A	B	bp	C	D	E	HE	A1	Lp
mm	1.40 0.95	2.04 1.78	0.50 0.35	0.19 0.08	3.10 2.70	1.65 1.20	3.00 2.20	0.100 0.013	0.50 0.20

X-ON Electronics

Largest Supplier of Electrical and Electronic Components

Click to view similar products for [Bipolar Transistors - BJT category](#):

Click to view products by [TWGMC manufacturer](#):

Other Similar products are found below :

[619691C](#) [MCH4017-TL-H](#) [MJ15024/WS](#) [MJ15025/WS](#) [BC546/116](#) [BC556/FSC](#) [BC557/116](#) [BSW67A](#) [HN7G01FU-A\(T5L,F,T](#)
[NJVMJD148T4G](#) [NSVMMBT6520LT1G](#) [NTE187A](#) [NTE195A](#) [NTE2302](#) [NTE2330](#) [NTE2353](#) [NTE316](#) [IMX9T110](#) [NTE63](#) [NTE65](#)
[C4460](#) [SBC846BLT3G](#) [2SA1419T-TD-H](#) [2SA1721-O\(TE85L,F\)](#) [2SA1727TLP](#) [2SA2126-E](#) [2SB1202T-TL-E](#) [2SB1204S-TL-E](#) [2SC5488A-](#)
[TL-H](#) [2SD2150T100R](#) [SP000011176](#) [FMC5AT148](#) [2N2369ADCSM](#) [2SB1202S-TL-E](#) [2SC2412KT146S](#) [2SC4618TLN](#) [2SC5490A-TL-H](#)
[2SD1816S-TL-E](#) [2SD1816T-TL-E](#) [CMXT2207 TR](#) [CPH6501-TL-E](#) [MCH4021-TL-E](#) [BC557B](#) [TTC012\(Q\)](#) [BULD128DT4](#) [JANTX2N3810](#)
[Jantx2N5416](#) [US6T6TR](#) [KSF350](#) [068071B](#)