

N-Channel Enhancement Mode Power MOSFET

- Features**

$V_{DS} = 30V,$

$I_D = 4.3A$

$R_{DS(ON)} @V_{GS} = 10V, TYP 28m\Omega$

$R_{DS(ON)} @V_{GS} = 4.5V, TYP 32 m\Omega$

$R_{DS(ON)} @V_{GS} = 2.5V, TYP 47 m\Omega$

- General Description**

- load switch
- PWM applications

- Pin Configurations**

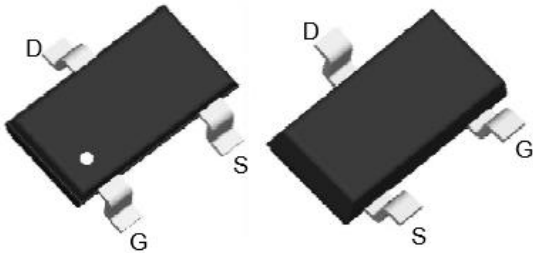

SOT23

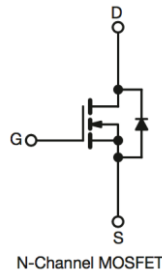

- Absolute Maximum Ratings @ $T_A=25^\circ C$ unless otherwise noted**

Parameter	Symbol	Ratings	Unit
Drain-Source Voltage	V_{DSS}	30	V
Gate-Source Voltage	V_{GSS}	± 12	V
Drain Current (Continuous) *AC	I_D	$T_A=25^\circ C$	4.3
		$T_A=70^\circ C$	3.5
Drain Current (Pulse) *B	I_{DM}	17	A
Power Dissipation	P_D	1.25	W
Operating Temperature/ Storage Temperature	T_J/T_{STG}	-55~150	$^\circ C$

- Thermal Resistance Ratings**

Parameter	Symbol	Maximum	Unit
Maximum Junction-to-Ambient	R_{thJA}	100	$^\circ C/W$

● Electrical Characteristics @T_A=25°C unless otherwise noted

Parameter	Symbol	Test Conditions	Min	Typ	Max	Unit
Static						
Drain-Source Breakdown Voltage	V _{(BR)DSS}	V _{GS} = 0V, I _D = 250μA	30	--	--	V
Zero Gate Voltage Drain Current	I _{DSS}	V _{DS} = 30 V, V _{GS} = 0V	--	--	1	μA
Gate Threshold Voltage	V _{GS(TH)}	V _{GS} = V _{DS} , I _{DS} = 250μA	0.5	--	1.5	V
Gate Leakage Current	I _{GSS}	V _{GS} = ±12V, V _{DS} = 0V	--	--	±100	nA
Drain-Source On-state Resistance	R _{DS(on)}	V _{GS} = 10V, I _D = 5A	--	28	36	mΩ
	R _{DS(on)}	V _{GS} = 4.5V, I _D = 5A	--	32	42	mΩ
	R _{DS(on)}	V _{GS} = 2.5V, I _D = 4A	--	47	61	mΩ
Diode Forward Voltage	V _{SD}	I _{SD} = 1A, V _{GS} = 0V	--	--	1	V
Diode Forward Current	I _S	T _A = 25°C	--	--	4.9	A
Switching						
Total Gate Charge	Q _g	V _{DS} = 15V, I _D = 4.8A, V _{GS} = 4.5V	--	9	--	nC
Gate-Source Charge	Q _{gs}		--	1	--	nC
Gate-Drain Charge	Q _{gd}		--	2	--	nC
Turn-on Delay Time	t _{d(on)}	V _{DD} = 15V, I _D = 4.8A, V _{GS} = 10V, R _{GEN} = 3Ω	--	10	--	ns
Turn-on Rise Time	t _r		--	3	--	ns
Turn-off Delay Time	t _{d(off)}		--	40	--	ns
Turn-Off Fall Time	t _f		--	2	--	ns
Dynamic						
Input Capacitance	C _{iss}	V _{DS} = 15V, V _{GS} = 0V, f = 1.0 MHz	--	735	--	pF
Output Capacitance	C _{oss}		--	90	--	pF
Reverse Transfer Capacitance	C _{rss}		--	65	--	pF

A: The value of R_{θJA} is measured with the device mounted on 1in² FR-4 board with 2oz. Copper, in a still air environment with T_A=25°C. The value in any given application depends on the user's specific board design.

B: Repetitive rating, pulse width limited by junction temperature.

C: The current rating is based on the t_s 10s junction to ambient thermal resistance rating.

● Typical Performance Characteristics ((T_J = 25 °C, unless otherwise noted))

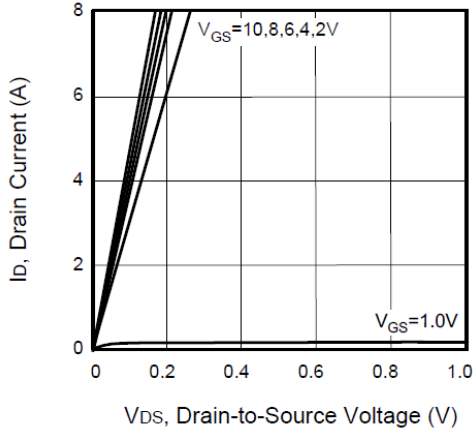

Figure 1. Output Characteristics

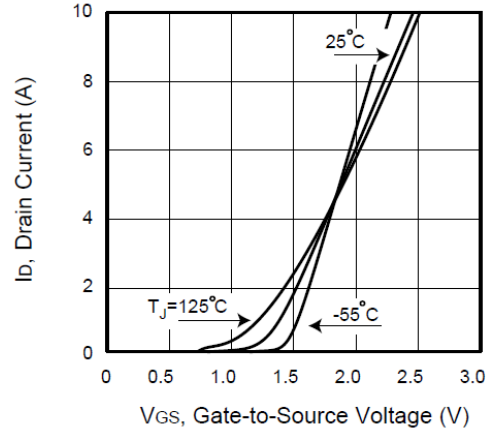

Figure 2. Transfer Characteristics

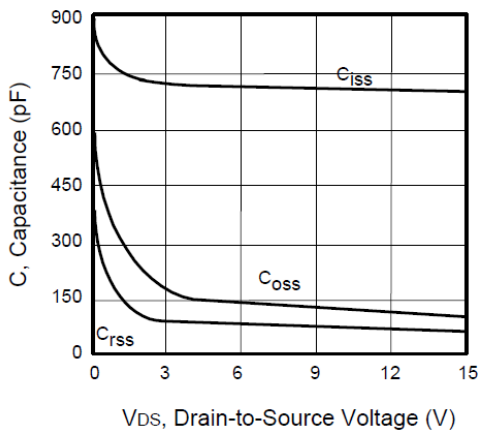

Figure 3. Capacitance

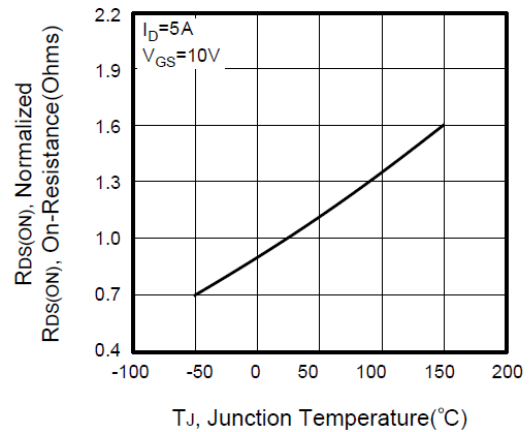

Figure 4. On-Resistance Variation with Temperature

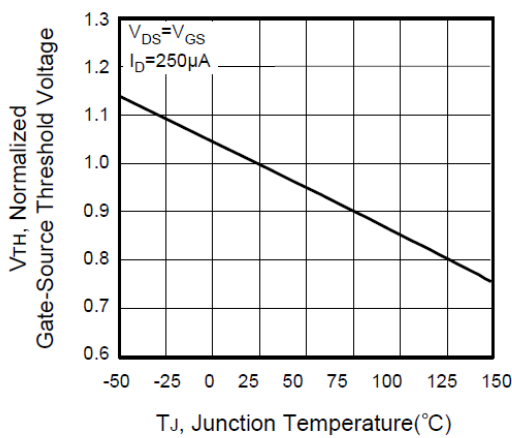

Figure 5. Gate Threshold Variation with Temperature

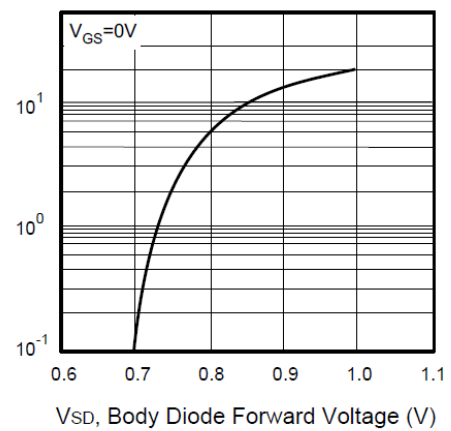

Figure 6. Body Diode Forward Voltage Variation with Source Current

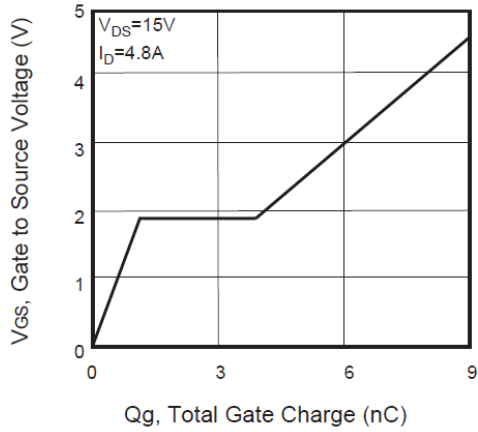

Figure 7. Gate Charge

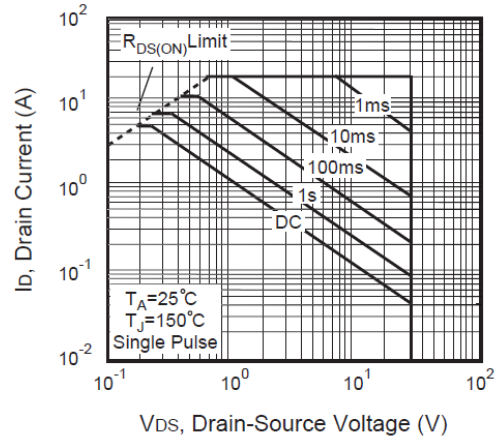

Figure 8. Maximum Safe Operating Area

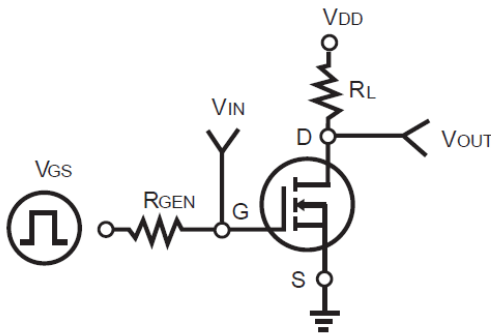

Figure 9. Switching Test Circuit

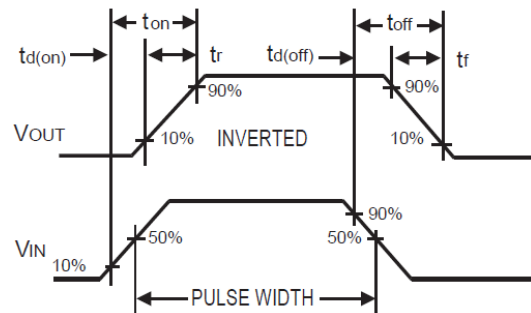

Figure 10. Switching Waveforms

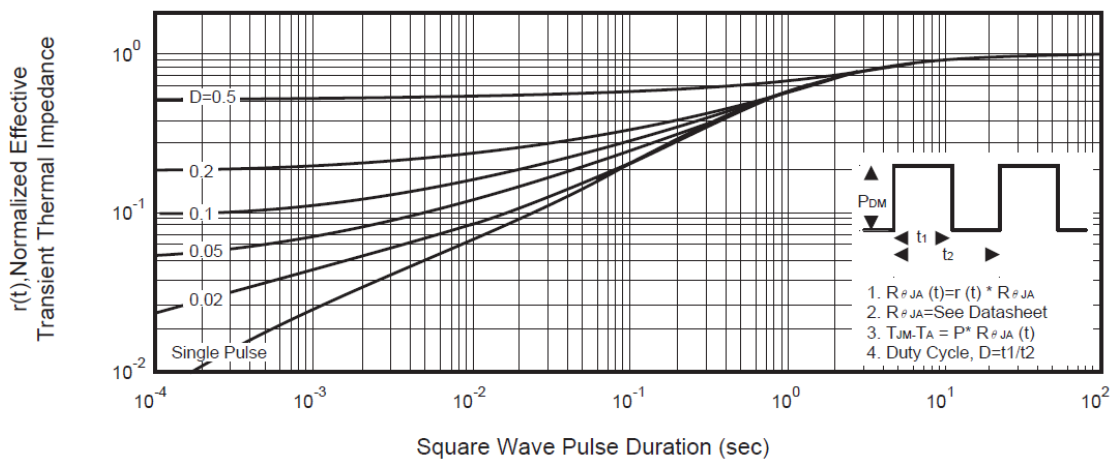
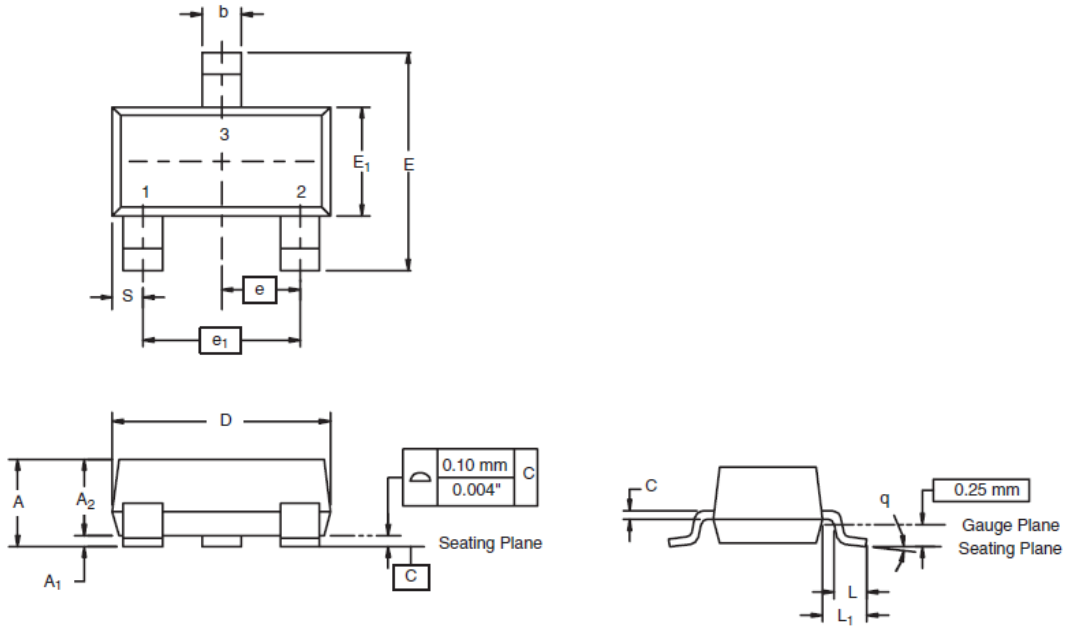

Figure 11. Normalized Thermal Transient Impedance Curve

● Package Information



Dim	MILLIMETERS		INCHES	
	Min	Max	Min	Max
A	0.89	1.12	0.035	0.044
A ₁	0.01	0.10	0.0004	0.004
A ₂	0.88	1.02	0.0346	0.040
b	0.35	0.50	0.014	0.020
c	0.085	0.18	0.003	0.007
D	2.80	3.04	0.110	0.120
E	2.10	2.64	0.083	0.104
E ₁	1.20	1.40	0.047	0.055
e	0.95 BSC		0.0374 Ref	
e ₁	1.90 BSC		0.0748 Ref	
L	0.40	0.60	0.016	0.024
L ₁	0.64 Ref		0.025 Ref	
S	0.50 Ref		0.020 Ref	
q	3°	8°	3°	8°

X-ON Electronics

Largest Supplier of Electrical and Electronic Components

Click to view similar products for [MOSFET](#) category:

Click to view products by [TWGMC](#) manufacturer:

Other Similar products are found below :

[IRFD120](#) [JANTX2N5237](#) [BUK455-60A/B](#) [MIC4420CM-TR](#) [VN1206L](#) [NDP4060](#) [SI4482DY](#) [IPS70R2K0CEAKMA1](#) [SQD23N06-31L-GE3](#)
[TK16J60W,S1VQ\(O](#) [2SK2614\(TE16L1,Q\)](#) [DMN1017UCP3-7](#) [DMN1053UCP4-7](#) [SQJ469EP-T1-GE3](#) [NTE2384](#) [DMC2700UDMQ-7](#)
[DMN2080UCB4-7](#) [DMN61D9UWQ-13](#) [US6M2GTR](#) [DMN31D5UDJ-7](#) [DMP22D4UFO-7B](#) [DMN1006UCA6-7](#) [DMN16M9UCA6-7](#)
[STF5N65M6](#) [IRF40H233XTMA1](#) [STU5N65M6](#) [DMN6022SSD-13](#) [DMN13M9UCA6-7](#) [DMTH10H4M6SPS-13](#) [DMN2990UFB-7B](#)
[IPB80P04P405ATMA2](#) [2N7002W-G](#) [MCAC30N06Y-TP](#) [MCQ7328-TP](#) [BXP7N65D](#) [BXP4N65F](#) [AOL1454G](#) [WMJ80N60C4](#) [BXP2N20L](#)
[BXP2N65D](#) [BXT1150N10J](#) [BXT1700P06M](#) [TSM60NB380CP](#) [ROG](#) [RQ7L055BGTCR](#) [DMNH15H110SK3-13](#) [SLF10N65ABV2](#)
[BSO203SP](#) [BSO211P](#) [IPA60R230P6](#) [IPA60R460CE](#)