

SPECIFICATION FOR APPROVAL

CUSTOMER : _____

PRODUCT TYPE : SMD SEAM SEALING X'TAL 3.2×2.5

NOMINAL FREQ. : 40.000000MHz

TXC P/N : 7M40000010

REVISION : A5

CUSTOMER P/N : _____

PM / SALES : _____

DATE : _____

CUSTOMER SIGNATURE & Date

- (1) TXC requires one copy returned with signature and title of authorized individual that signifies acceptance of the attached specifications.
- (2) Orders received and accepted by TXC after return of signed copy of specification will be produced per these specifications.
- (3) Any changes to these specifications must be agreed upon by both parties and new revision of the Product Specification Sheet will be issued.
- (4) Any issuance of purchase order prior to consigning back the Approval page of "Specification Sheets" from customers will be regarded as the agreement on the contents of these specifications.

MSL:Level 1
RoHS Compliant



PRODUCT SPECIFICATION SHEET

PRODUCT TYPE : SMD SEAM SEALING X'TAL 3.2×2.5

NOMINAL FREQ. : 40.000000MHz

TXC P/N : 7M40000010

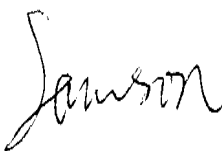
REVISION : A5

PE/RD	QA	MFG
		
12-Mar-12	12-Mar-12	12-Mar-12

NOTE:

- (1)Lead Free Products are "Directive 2002/95/EC of The European Parliament of 27 January 2003 on the restriction of the use of certain hazardous substances (RoHS) in electrical and electronic equipment" Compliant (Attachment: SGS Test Report).
- (2)Revision "Sx" is for engineering samples only. PE/RD's approval required.
- (3)Revision "Ax" is production ready. PE, QA and MFG's approval required

MSL:Level 1
RoHS Compliant

<u>Rev</u>	<u>Revise page</u>	<u>Revise contents</u>	<u>Date</u>	<u>Ref.No.</u>	<u>Reviser</u>
A1	N/A	Initial released	5-Jan-09	N/A	Yachuan Miao
A2	2	Change Rr:30 ohm to 20 ohm Add DLD2:6 ohm	21-Apr-09	ECN-09P042102	Yachuan Miao
A3	2	Change Rr:20 ohm to 15 ohm	15-May-09	ECN-09P051501	Yachuan Miao
A4	1~9	Increase Contents	11-Oct-11	N/A	Xiaoyan Jiang
A5	N/A	C0,OP,DL Change	12-Mar-12	ECR-12N031405	Xiaoyan Jiang

Spec Sheet Contents

No.	Content	Page
1	ELECTRICAL SPECIFICATIONS	P.3
2	FACTORY LOCATION	P.3
3	DIMENSIONS	P.4
4	MARKING	P.4
5	SUGGESTED REFLOW PROFILE& MANUAL SOLDER CONDITION	P.4
6	STRUCTURE ILLUSTRATION	P.5
7	EMBOSS CARRIER TAPE & REEL	P.6
8	PACKING	P.7
9	RELIABILITY SPECIFICATIONS	P.8~9

■ ELECTRICAL SPECIFICATIONS

Standard atmospheric conditions

Unless otherwise specified, the standard range of atmospheric conditions for making measurement and tests are as follow:

Ambient temperature : 25±5°C

Relative humidity : 40%~70%

If there is any doubt about the results, measurement shall be made within the following limits:

Ambient temperature : 25±3°C

Relative humidity : 40%~70%

Measure equipment

Electrical characteristics measured by S&A250B or equivalent.

Crystal cutting type

The crystal is using AT CUT (thickness shear mode).

Unit Weight:

0.018±0.001 g/pcs

	Parameters	SYM.	Electrical Spec.				Notes
			MIN	TYPE	MAX	UNITS	
1	Nominal Frequency	FL	40.000000			MHz	-
2	Oscillation Mode	-	Fundamental			-	-
3	Load Capacitance	CL	12			pF	-
4	Frequency Tolerance	-	±10			ppm	at 25 °C ± 3 °C
5	Frequency Stability	-	±10			ppm	Over Operating Temp. Range (Reference 25°C)
6	Operating Temperature	-	-30	~	85	°C	-
7	Aging	-	±2			ppm	1st Year
8	Drive Level	DL	-	10	100	uW	-
9	Effective Resistance Rr	Rr	-	-	15	Ω	-
10	Shunt Capacitance C0	C0	-	-	2	pF	-
11	Insulation Resistance	-	500	-	-	MΩ	at DC 100V
12	Storage Temperature Range	-	-40	~	85	°C	-
13	DLD2	-	-	-	6	Ω	-

■ FACTORY LOCATION

TXC (NINGBO) CORPORATION

NO.189 Huang Shan West Road, Beilun District,

Ningbo Zhejiang China

■ DIMENSIONS

(Unit:mm)

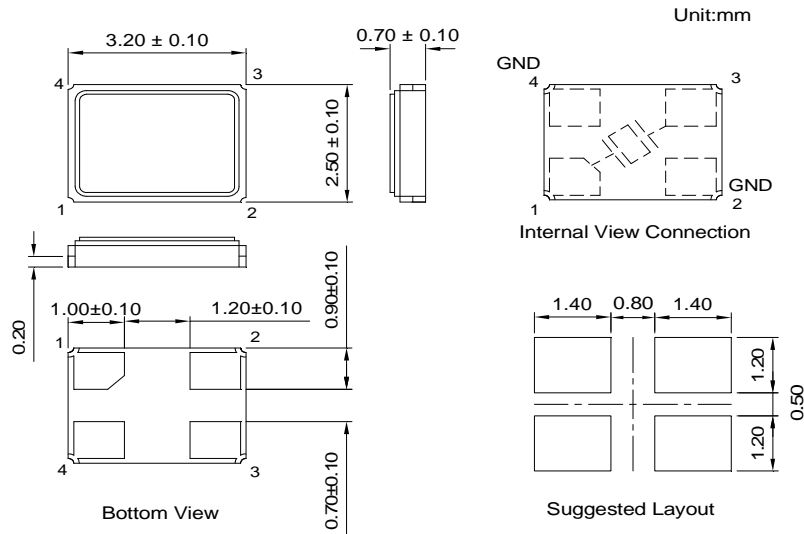

*Coplanarity of solderable areas Camber 0.10 mm Max

■ MARKING

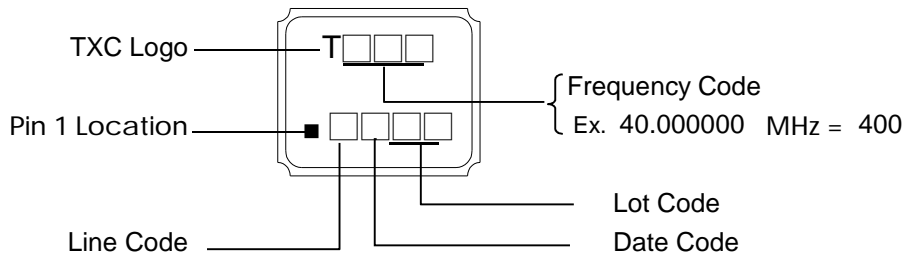

Date Code:

YEAR		MONTH													
		JAN	FEB	MAR	APR	MAY	JUN	JUL	AUG	SEP	OCT	NOV	DEC		
2005	2009	2013	2017	A	B	C	D	E	F	G	H	J	K	L	M
2006	2010	2014	2018	N	P	Q	R	S	T	U	V	W	X	Y	Z
2007	2011	2015	2019	a	b	c	d	e	f	g	h	j	k	l	m
2008	2012	2016	2020	n	p	q	r	s	t	u	v	w	x	y	z

*This date code will be cycled every four years

■ SUGGESTED REFLOW PROFILE

Solder melting point :220±10 °C, 60 sec. Min.
Peak Temperature: 260 ± 5 °C, 10 sec. Max.

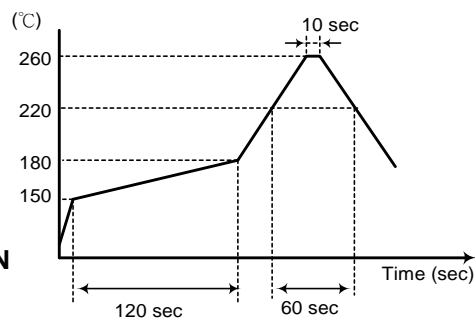

■ SUGGESTED MANUAL SOLDER CONDITION

Temperature: 350 ± 10 °C
Time: 3 sec.
Re-solder times: twice

■ **STRUCTURE ILLUSTRATION**

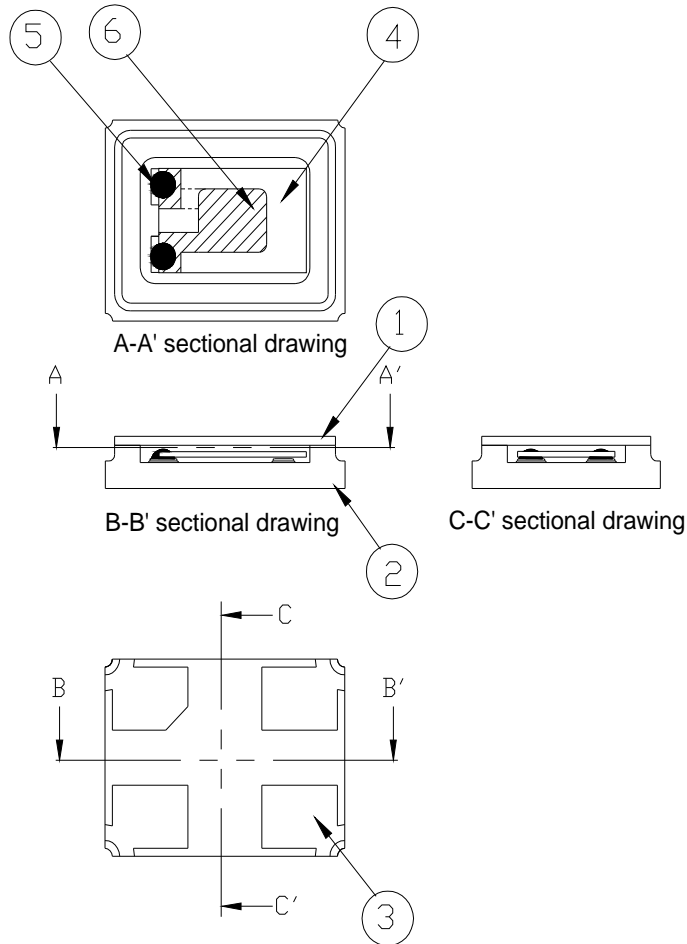

NO	COMPONENTS	MATERIALS	FINISH/SPECIFICATIONS
1	Lid	Kovar (Fe/Co/Ni)	-
2	Package	Ceramic (Al ₂ O ₃) + Kovar (Fe/Co/Ni)+ Ag/Cu	-
3	PAD	Au	Tungsten metalize + Ni plating + Au plating
4	Crystal blank	SiO ₂	-
5	Conductive adhesive	Resin+Ag	-
6	Electrode	Noble Metal	-

■ **EMBOSS CARRIER TAPE & REEL**

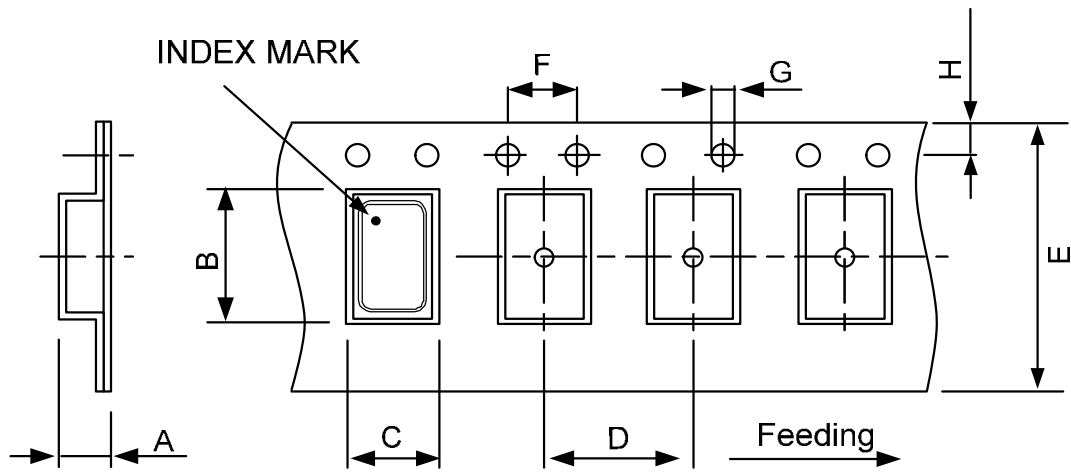

DIMENSIONS	A	B	C	D	E	F	G	H	(UNIT : mm)
	1.65±0.10	3.40±0.10	2.70±0.10	4.00±0.10	8.00±0.20	4.00±0.10	1.55±0.10	1.75±0.10	

REMARK :

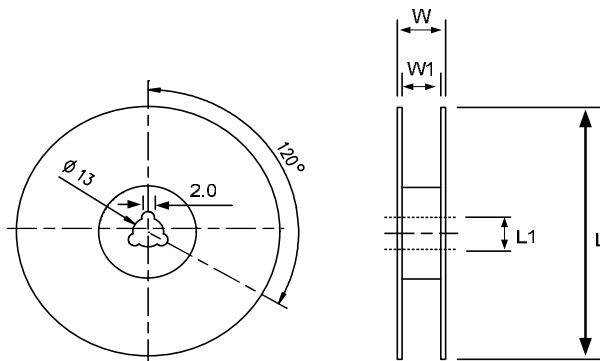
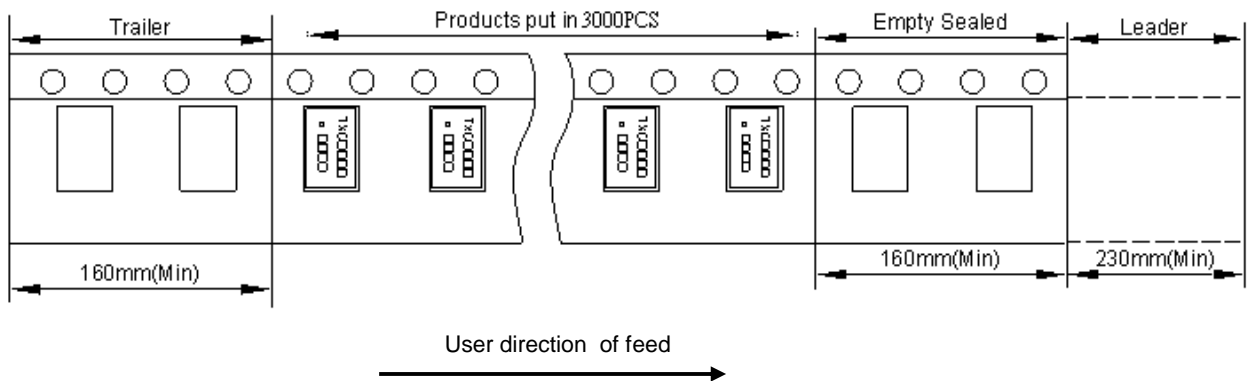

DIMENSIONS	L	L1	W	W1	(UNIT : mm)
	178±1.00	13±0.50	11.5±0.20	8±0.10	

PACKING

Reel Quantity :

- 1. Reel X 6 (6 Reels)
- 2. Reel X 12 (12 Reels)
- 3. Reel X 25 (12 Reels + 13 Reels)
- 4. Reel X 50 (12 Reelsx2 + 13 Reelsx2)

Box Size:

- 1. L200 X W200 X H140mm
- 2. L200 X W200 X H250mm
- 3. L400 X W200 X H250mm
- 4. L400 X W400 X H280mm

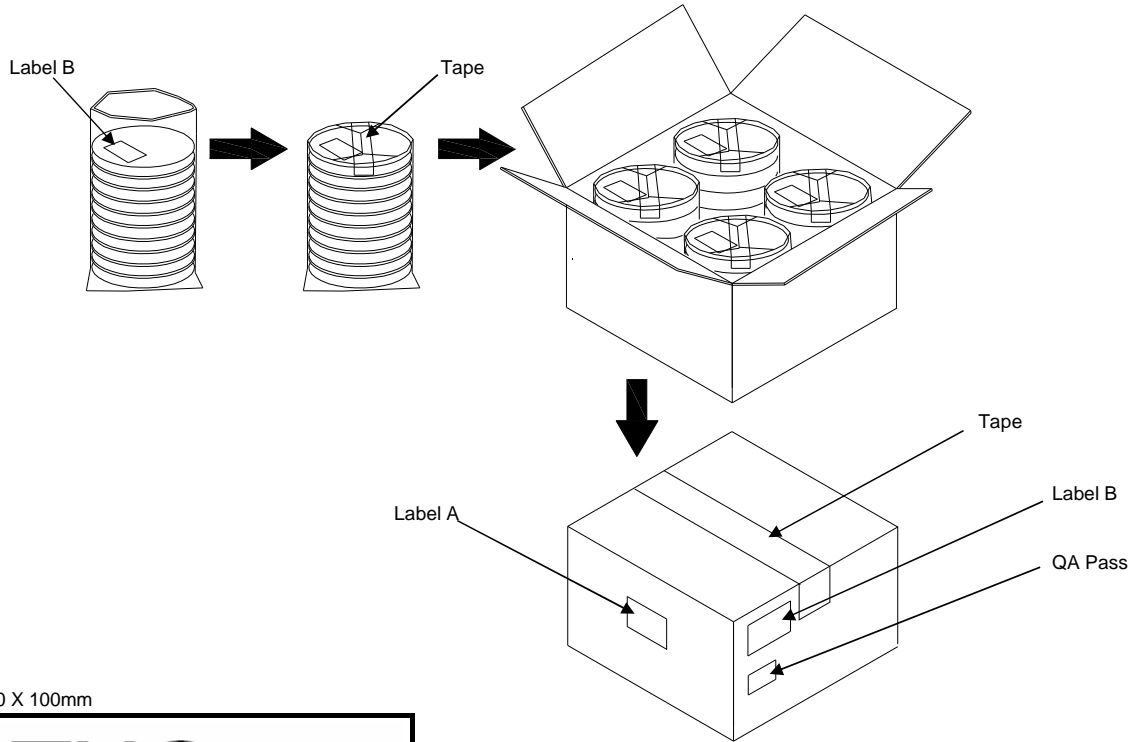

(Label A) Size:100 X 100mm

TXC
Inv No: 00096815
Po No: 21106326- 24- 1
Part No:
Qty: 40000 PCS
C/No: 157- 44

(Label B) Size:80 X 40mm

TXC CORPORATION		QA PASS
DATE CODE		QTY:
 		2011/05/02
LC NO:		<div style="border: 1px solid black; padding: 5px; display: inline-block;">RoHS</div> <div style="border: 1px solid black; padding: 5px; display: inline-block;">HF</div>
PART NO:		
 		
FREQ:	 	

[STORAGE]

- 1.The storage time to be 1 year maximum.
- 2.Don't be caught in the rain.
- 3.The storage environment shall be 5°C ~40°C temperature and 30% ~ 75%RH humidity and free from the sun shine.
- 4.If customers have special requirements, we can paste labels according to it.

RELIABILITY SPECIFICATIONS

1. Mechanical Endurance

No.	Test Item	Test Methods	Test Criteria
1	Drop Test	150 cm height, 3 times on concrete floor .	A . C
1	Mechanical Shock	Device are shocked to half sine wave (1000 G) three mutually perpendicular axes each 3 times. 0.5 ms duration time	A . C
1	Vibration	Frequency range 10 ~ 2000 Hz Amplitude 1.52 mm/20G Sweep time 20 minutes Perpendicular axes each test time 4 Hrs (Total test time 12 Hrs)	A . C
1	Solderability	Temperature 245 °C ± 5°C Immersing depth 0.5 mm minimum Immersion time 5 ± 1 seconds Flux Rosin resin methyl alcohol solvent (1 : 4)	E

2. Environmental Endurance

No.	Test Item	Test Methods	Test Criteria
2	Resistance To Soldering Heat	Pre-heat temperature 125 °C Pre-heat time 60 ~ 120 sec. Test temperature 260 ± 5 °C Test time 10 ± 1 sec.	B . C . D
2	High Temp. Storage	+ 125 °C ± 3 °C for 500 ± 12 Hrs	B . C . D
2	Low Temp. Storage	- 40 °C ± 3 °C for 500 ± 12 Hrs	B . C . D
2	Temperature cycle	Total 100 cycles of the following temperature cycle 	B . C . D
3	High Temp & Humidity	85°C ± 3°C , RH 85% , 500 Hrs	B . C . D

RELIABILITY SPECIFICATIONS

Specifications	
A	Frequency change: Within ± 5 ppm or in customer's specification.
B	Frequency change: Within ± 10 ppm or in customer's specification.
C	Equivalent series resistance(E.S.R) change: Within $\pm 15\%$ or 10Ω (larger value).
D	After conditioning , quartz crystal units shall be subjected to standard atmospheric conditions for 2 hour, and measured.
E	Minimum 95% of immersed terminal shall be covered with new uniform solder.

Measurement condition

Electrical characteristics measured by S&A250B or equivalent.

X-ON Electronics

Largest Supplier of Electrical and Electronic Components

Click to view similar products for [Crystals](#) category:

Click to view products by [TXC Corporation](#) manufacturer:

Other Similar products are found below :

[CX3225GB25000M0PPSZ1](#) [718-13.2-1](#) [MC405 32.0000K-R3:PURE SN](#) [7A-40.000MAAE-T](#) [FL2000085](#) [99-BU](#) [9B-15.360MBBK-B](#) [9C-7.680MBBK-T](#) [H10S-12.000-18-EXT-TR](#) [ABC2-6.000MHZ-D4Z-T](#) [ABLS-20.000MHZ-D2-T](#) [ABS071-32.768KHZ-6-T](#) [R38-32.768-12.5-5PPM-NPB](#) [BTD1062E05A-513](#) [21U15A-21.4MHZ](#) [RTX-781DF1-S-20.950](#) [LFXTAL066198Cutt](#) [9C-14.31818MBBK-T](#) [A-11.000MHZ-27](#) [ABL-27.000MHZ-B4Y-T](#) [ABM11-132-24.000MHZ-T3](#) [ABM3B1-25.000MHZ-D2Y-T](#) [SPT2A-.032768B](#) [SPT2A.032768G](#) [SSPT7F-9PF20-R](#) [FX325BS-38.88EEM1201](#) [LFXTAL065253Cutt](#) [LFXTAL066431Cutt](#) [XT9S20ANA14M7456](#) [XT9SNLANA16M](#) [646G-24-2](#) [7A-24.576MBBK-T](#) [7B-30.000MBBK-T](#) [7A-14.31818MBBK-T](#) [6504-202-1501](#) [6526-202-1501](#) [ABLS-12.000MHZ-B2Y-T](#) [ABLS-10.000MHZ-D3W-T](#) [7A-10.000MBBK-T](#) [SG636PCE-20.000MC](#) [3404](#) [E1SAA18-25.000M TR](#) [CM315D32768EZFT](#) [C1E-24.000-7-2020-R](#) [C1E-19.200-12-1530-X-R](#) [C1E-16.000-12-1530-X-R](#) [FL5000014](#) [EUCA18-3.1872M](#) [FX0800015](#) [425F35E027M0000](#)