



TXC CORPORATION

4F, NO. 16, Sec. 2 Chung Yang S Rd., Peitou, Taipei, Taiwan.

TEL : 886-2-2894-1202 , 886-2-2895-2201 FAX : 886-2-2894-1206 , 886-2-2895-6207

www.txccorp.com

SPECIFICATION FOR APPROVAL

CUSTOMER : _____

PRODUCT TYPE : SMD GLASS SEALING XTAL 3.2 × 2.5

NOMINAL FREQ. : 25.000000MHz

TXC P/N : 7V25000018

REVISION : A1

CUSTOMER P/N : _____

PM / SALES : _____

DATE : _____

CUSTOMER SIGNATURE & Date _____

- (1) TXC requires one copy returned with signature and title of authorized individual that signifies acceptance of the attached specifications.
- (2) Orders received and accepted by TXC after return of signed copy of specification will be produced per these specifications.
- (3) Any changes to these specifications must be agreed upon by both parties and new revision of the Product Specification Sheet will be issued.
- (4) Any issuance of purchase order prior to consigning back the Approval page of "Specification Sheets" from customers will be regarded as the agreement on the contents of these specifications.

**MSL:Level 1
RoHS Compliant**

Pb used in sealing glass material is exempt from EU directive



PRODUCT SPECIFICATION SHEET

PRODUCT TYPE : SMD GLASS SEALING XTAL 3.2 × 2.5

NOMINAL FREQ. : 25.000000MHz

TXC P/N : 7V25000018

REVISION : A1

| PE/RD | QA | MFG |
|--|---|--|
|  Robin Huang |  Samson Xiong |  Min-ChiangChao |
| <i>31-Aug-12</i> | <i>31-Aug-12</i> | <i>31-Aug-12</i> |

NOTE:

- (1)Lead Free Products are "Directive 2002/95/EC of The European Parliament of 27 January 2003 on the restriction of the use of certain hazardous substances (RoHS) in electrical and electronic equipment" Compliant (Attachment: SGS Test Report).
- (2)Revision "Sx" is for engineering samples only. PE/RD's approval required.
- (3)Revision "Ax" is production ready. PE, QA and MFG's approval required

MSL:Level 1
RoHS Compliant

Pb used in sealing glass material is exempt from EU directive

Spec Sheet Contents

| No. | Content | Page |
|-----|---|-------|
| 1 | ELECTRICAL SPECIFICATIONS | P.3 |
| 2 | FACTORY LOCATION | P.3 |
| 3 | DIMENSIONS | P.4 |
| 4 | MARKING | P.4 |
| 5 | SUGGESTED REFLOW PROFILE& MANUAL SOLDER CONDITION | P.4 |
| 6 | STRUCTURE ILLUSTRATION | P.5 |
| 7 | EMBOSS CARRIER TAPE & REEL | P.6 |
| 8 | PACKING | P.7 |
| 9 | RELIABILITY SPECIFICATIONS | P.8~9 |

ELECTRICAL SPECIFICATIONS

Standard atmospheric conditions

Unless otherwise specified, the standard range of atmospheric conditions for making measurement and tests are as follow:

- Ambient temperature : 25±5°C
- Relative humidity : 40%~70%

If there is any doubt about the results, measurement shall be made within the following limits:

- Ambient temperature : 25±3°C
- Relative humidity : 40%~70%

Measure equipment

Electrical characteristics measured by S&A250B or equivalent.

Crystal cutting type

The crystal is using AT CUT (thickness shear mode).

Unit Weight:

0.018±0.001 g/pcs

| | Parameters | SYM. | Electrical Spec. | | | | Notes |
|----|---------------------------|------|------------------|-----|-----|-------|--|
| | | | MIN | TYP | MAX | UNITS | |
| 1 | Nominal Frequency | FL | 25.000000 | | | MHz | - |
| 2 | Oscillation Mode | - | Fundamental | | | - | - |
| 3 | Load Capacitance | CL | 20 | | | pF | - |
| 4 | Frequency Tolerance | - | ±10 | | | ppm | at 25 ± 3 °C |
| 5 | Frequency Stability | - | ±20 | | | ppm | Over Operating Temp. Range (Reference 25°C) |
| 6 | Operating Temperature | - | -40 | ~ | 85 | °C | - |
| 7 | Aging | - | ±3 | | | ppm | 1st Year |
| 8 | Drive Level | DL | - | 100 | - | uW | - |
| 9 | Equivalent Resistance Rr | Rr | - | - | 50 | Ω | - |
| 10 | Shunt Capacitance C0 | C0 | - | - | - | pF | - |
| 11 | Insulation Resistance | - | 500 | - | - | MΩ | at DC 100V |
| 12 | Storage Temperature Range | - | -40 | ~ | 85 | °C | - |

FACTORY LOCATION

TXC (NINGBO) CORPORATION
 NO.189 Huang Shan West Road, Beilun District,
 Ningbo Zhejiang China

■ DIMENSIONS

(Unit:mm)

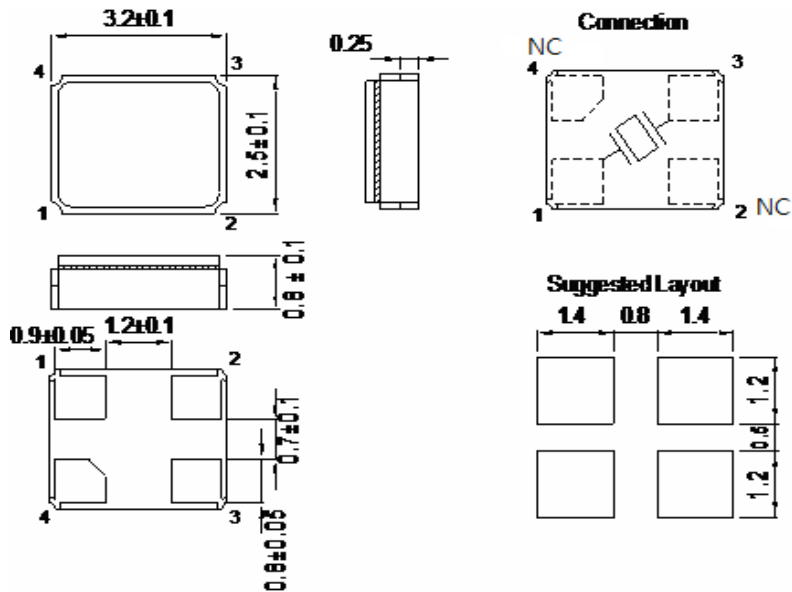

*Coplanarity of solderable areas Camber 0.10 mm Max

■ MARKING

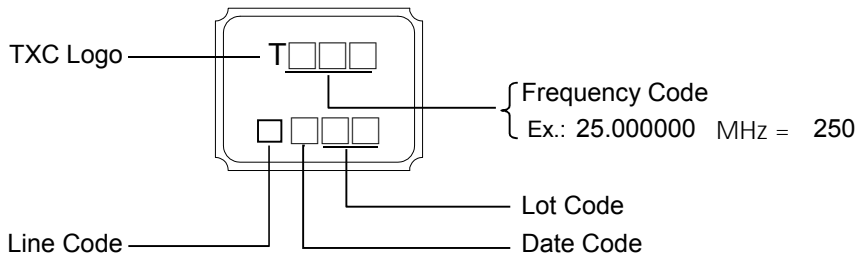

Date Code:

| YEAR | | MONTH | | | | | | | | | | | | | |
|------|------|-------|------|-----|-----|-----|-----|-----|-----|-----|-----|-----|-----|---|---|
| | | JAN | FEB | MAR | APR | MAY | JUN | JUL | AUG | SEP | OCT | NOV | DEC | | |
| 2005 | 2009 | 2013 | 2017 | A | B | C | D | E | F | G | H | J | K | L | M |
| 2006 | 2010 | 2014 | 2018 | N | P | Q | R | S | T | U | V | W | X | Y | Z |
| 2007 | 2011 | 2015 | 2019 | a | b | c | d | e | f | g | h | j | k | l | m |
| 2008 | 2012 | 2016 | 2020 | n | p | q | r | s | t | u | v | w | x | y | z |

*This date code will be cycled every four years

■ SUGGESTED REFLOW PROFILE

Solder melting point :220±10 °C, 60 sec. Min.
Peak Temperature: 260 ± 5 °C, 10 sec. Max.

■ SUGGESTED MANUAL SOLDER CONDITION

Temperature: 350 ± 10 °C
Time: 3 sec.
Re-solder times: twice

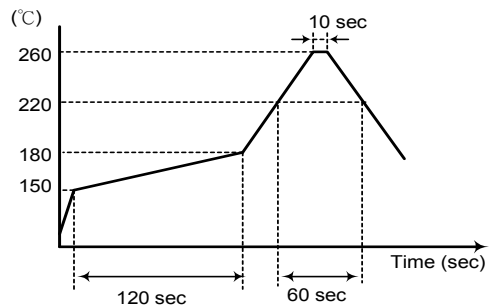

■ STRUCTURE ILLUSTRATION

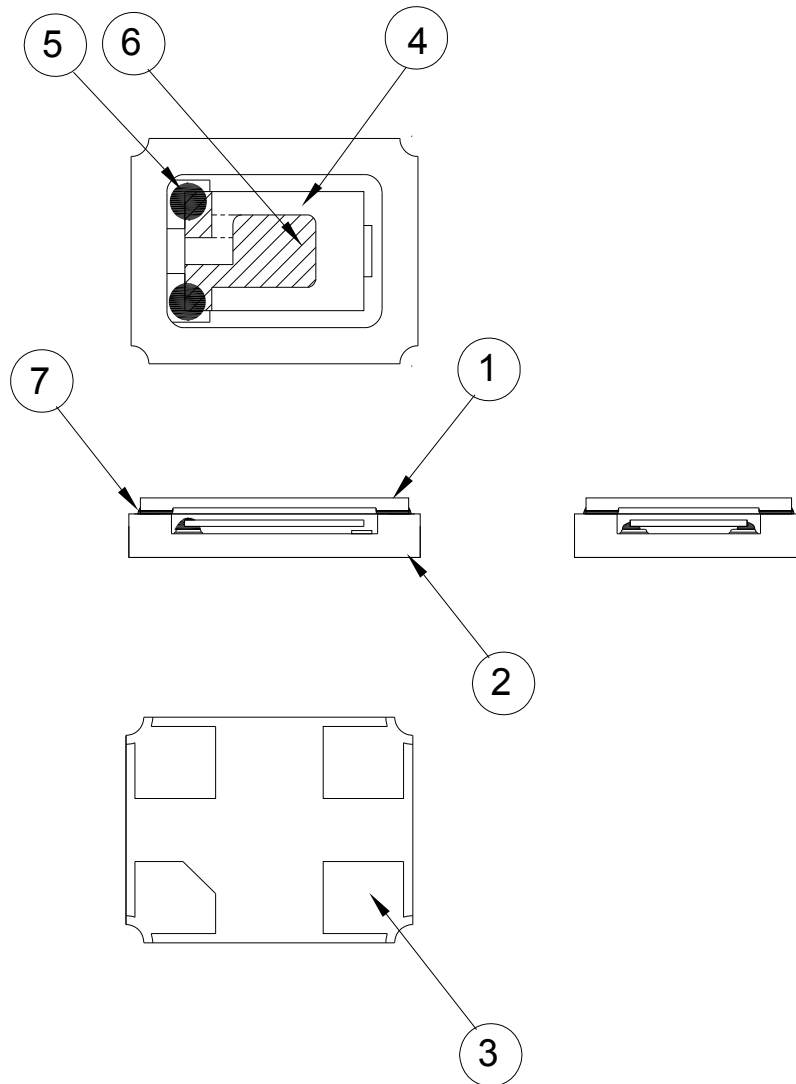

| NO | COMPONENTS | MATERIALS | FINISH/SPECIFICATIONS |
|----|---------------------|---|---|
| 1 | Cap | Ceramic (Al ₂ O ₃) | - |
| 2 | Package | Ceramic (Al ₂ O ₃) | - |
| 3 | PAD | Au | Tungsten metalize + Ni plating + Au plating |
| 4 | Crystal blank | SiO ₂ | - |
| 5 | Conductive adhesive | Resin+Ag | - |
| 6 | Electrode | Ag | - |
| 7 | Sealing Glass | Glass(PbO) | - |

■ EMOSS CARRIER TAPE & REEL

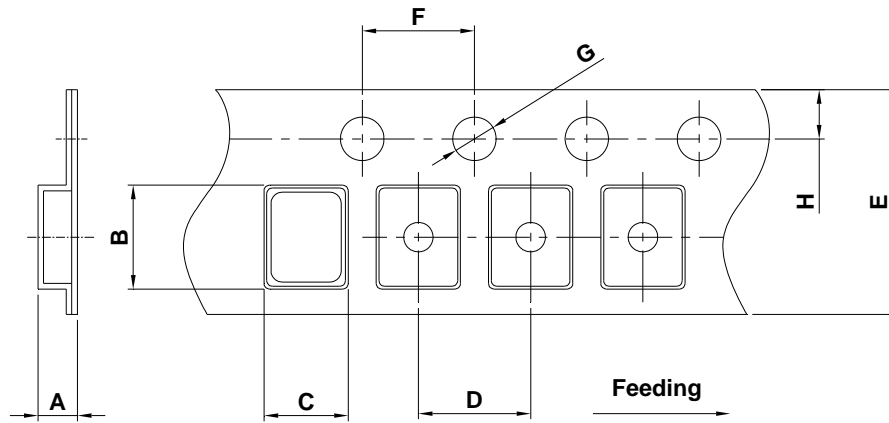

| DIMENSIONS | A | B | C | D | E | F | G | H | |
|------------|-----------|-----------|-----------|-----------|-----------|-----------|-----------|-----------|-------------|
| | 1.65±0.10 | 3.40±0.10 | 2.70±0.10 | 4.00±0.10 | 8.00±0.20 | 4.00±0.10 | 1.55±0.10 | 1.75±0.10 | (UNIT : mm) |

REMARK :

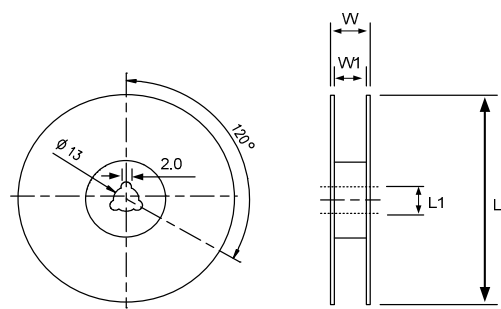
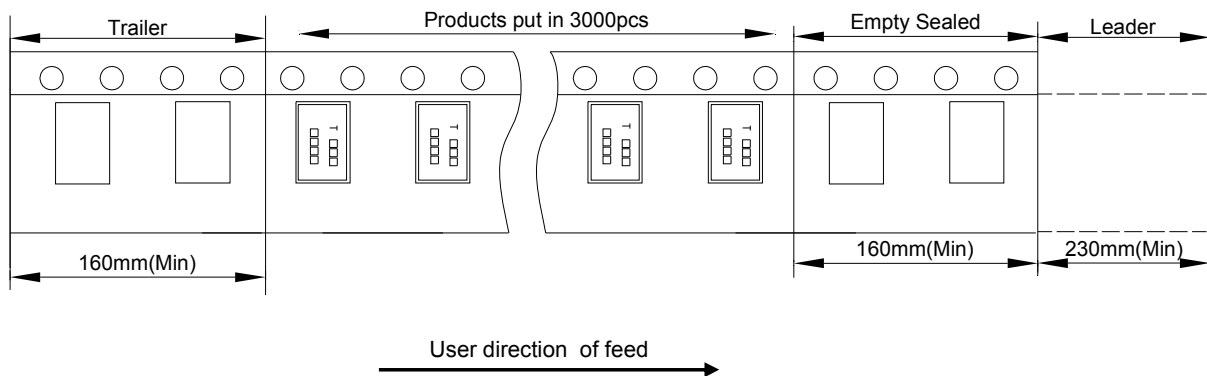

| DIMENSIONS | L | L1 | W | W1 | |
|------------|----------|---------|-----------|--------|-------------|
| | 178±1.00 | 13±0.50 | 11.5±0.20 | 8±0.10 | (UNIT : mm) |

PACKING

Reel Quantity :

- 1. Reel X 6 (6 Reels)
- 2. Reel X 12 (12 Reels)
- 3. Reel X 25 (12 Reels + 13 Reels)
- 4. Reel X 50 (12 Reelsx2 + 13 Reelsx2)

Box Size:

- 1. L200 X W200 X H140mm
- 2. L200 X W200 X H250mm
- 3. L400 X W200 X H250mm
- 4. L400 X W400 X H280mm

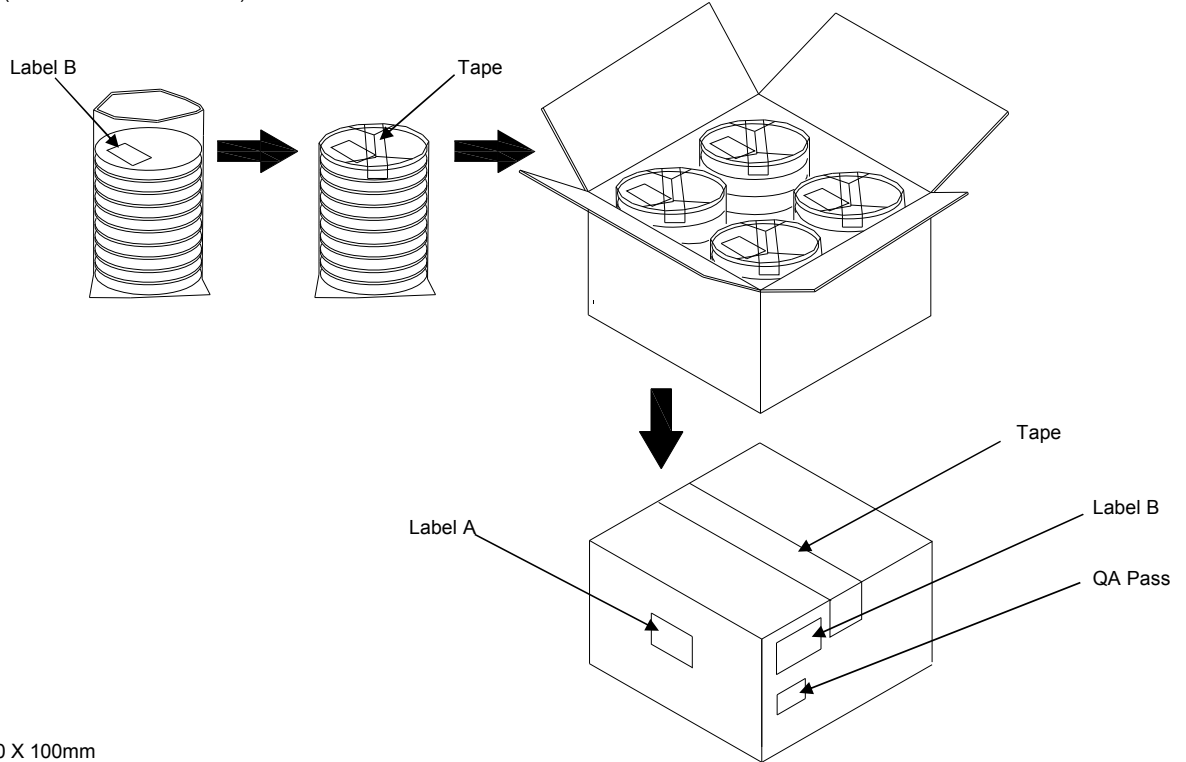

(Label A) Size:100 X 100mm

| | |
|--------------|-----------------|
| <h1>TXC</h1> | |
| Inv No: | 00096815 |
| Po No: | 21106326- 24- 1 |
| Part No: | □□□□□□□□ |
| Q'ty: | 40000 PCS |
| C/No: | 157- 44 |

(Label B) Size:80 X 40mm

| | | |
|-----------------|------------|------------|
| TXC CORPORATION | | QA PASS |
| DATE CODE: | | QTY: |
| □□□□□□□□ □□□□ | | 2011/09/02 |
| LOT NO: | | |
| □□□□□□□□ | | |
| PART NO: | | |
| □□□□□□□□ | | |
| FREQ: | □□□□□□□□□□ | |

[STORAGE]

- 1.The storage time to be 1 year maximum.
- 2.Don't be caught in the rain.
- 3.The storage environment shall be 5°C ~40°C temperature and 30% ~ 75%RH humidity and free from the sun shine.
- 4.If customers have special requirements, we can paste labels according to it.

RELIABILITY SPECIFICATIONS
1.Mechanical Endurance

| No. | Test Item | Test Methods | Test Criteria |
|-----|------------------|---|---------------|
| 1.1 | Drop Test | 75 cm height,3 times on concrete floor . | A . C |
| 1.2 | Mechanical Shock | Device are shocked to half sine wave (1000 G) three mutually perpendicular axes each 3 times. 0.5 ms duration time | A . C |
| 1.3 | Vibration | Frequency range 10 ~ 2000 Hz Amplitude 1.52 mm/20G Sweep time 20 minutes Perpendicular axes each test time 4 Hrs (Total test time 12 Hrs) | A . C |
| 1.4 | Solderability | Temperature 245 °C ± 5°C Immersing depth 0.5 mm minimum Immersion time 5 ± 1 seconds Flux Rosin resin methyl alcohol solvent (1 : 4) | E |

2.Environmental Endurance

| No. | Test Item | Test Methods | Test Criteria |
|-----|------------------------------|--|---------------|
| 2.1 | Resistance To Soldering Heat | Pre-heat temperature 125 °C Pre-heat time 60 ~ 120 sec. Test temperature 260 ± 5 °C Test time 10 ± 1 sec. | B . C . D |
| 2.2 | High Temp. Storage | + 125 °C ± 3 °C for 500 ± 12 Hrs | B . C . D |
| 2.3 | Low Temp. Storage | - 40 °C ± 3 °C for 500 ± 12 Hrs | B . C . D |
| 2.4 | Temperature cycle | Total 100 cycles of the following temperature cycle | B . C . D |
| 2.5 | High Temp & Humidity | 85°C ± 3°C , RH 85% , 500 Hrs | B . C . D |

RELIABILITY SPECIFICATIONS

| Specifications | |
|----------------|---|
| A | Frequency change: Within ± 5 ppm or in customer's specification. |
| B | Frequency change: Within ± 10 ppm or in customer's specification. |
| C | Equivalent series resistance(E.S.R) change: Within $\pm 15\%$ or 10Ω (larger value). |
| D | After conditioning , quartz crystal units shall be subjected to standard atmospheric conditions for 2 hour, and measured. |
| E | Minimum 95% of immersed terminal shall be covered with new uniform solder. |

Measurement condition

Electrical characteristics measured by S&A250B or equivalent.

X-ON Electronics

Largest Supplier of Electrical and Electronic Components

Click to view similar products for [Resonators](#) category:

Click to view products by [TXC Corporation](#) manufacturer:

Other Similar products are found below :

[B39431R820H210](#) [CSAC2.00MGCM-TC](#) [ECS-HFR-40.00-B-TR](#) [CSTLS4M00G53Z-A0](#) [ZTB455E](#) [ECS-CR2-16.00-A-TR](#) [ECS-HFR-20.00-B-TR](#) [ECS-CR2-20.00-A-TR](#) [RO3164E-3](#) [ASR418S2-T](#) [CSTNE10M0G520000R0](#) [CSTLS8M00G53093-A0](#) [CSTNE12M0G52A000R0](#) [CSTLS18M4X54-A0](#) [CSTLS16M9X53Z-B0](#) [CSTLS24M0X51-A0](#) [CSTLS25M0X51-B0](#) [CSTLS18M0X51-B0](#) [CSTLS4M00G53093-A0](#) [CSTLS18M4X53-A0](#) [CSTNE16M0V510000R0](#) [CSTLS30M0X53-B0](#) [CSTLS33M8X53-B0](#) [CSTLS16M9X53-A0](#) [CSTLS6M40G56-B0](#) [CSTLS6M25G56-A0](#) [CSTNE14M7V510000R0](#) [CSTLS18M4X53-B0](#) [CSTLS33M0X51-B0](#) [CSTLS5M50G56-B0](#) [7B008000I01](#) [7D038400I01](#) [TAXM24M2ILDBET2T](#) [TAXM26M2IHDBET2T](#) [146-32.768-12.5-20-20/A](#) [3225-24.00-12-10-10/A](#) [7B009843M01](#) [CF4016M00009T8188042](#) [S32400001B0730D1JB](#) [X252016MLB4SI](#) [Q24FA20H00389](#) [CSTLS16M0X54-B0](#) [CSTLS4M19G56-B0](#) [9AC04194152080D2JB](#) [CST3.58MGW](#) [CSTCR4M91G55B-R0](#) [CSTLS3M68G56-B0](#) [S2100327072090](#) [FC-12M32.768KHZ9PF20PPM](#) [7Y032768NW2](#)