

SPECIFICATION FOR APPROVAL

CUSTOMER : _____

PRODUCT TYPE : SMD GLASS SEALING XTAL 3.2 × 2.5

NOMINAL FREQ. : 27.138270MHz

TXC P/N : 7V27100004

REVISION : S1

CUSTOMER P/N : _____

PM / SALES : _____

DATE : _____

CUSTOMER SIGNATURE & Date

- (1) TXC requires one copy returned with signature and title of authorized individual that signifies acceptance of the attached specifications.
- (2) Orders received and accepted by TXC after return of signed copy of specification will be produced per these specifications.
- (3) Any changes to these specifications must be agreed upon by both parties and new revision of the Product Specification Sheet will be issued.
- (4) Any issuance of purchase order prior to consigning back the Approval page of "Specification Sheets" from customers will be regarded as the agreement on the contents of these specifications.

**MSL:Level 1
RoHS Compliant**

Pb used in sealing glass material is exempt from EU directive

PRODUCT SPECIFICATION SHEET

PRODUCT TYPE : SMD GLASS SEALING XTAL 3.2 × 2.5

NOMINAL FREQ. : 27.138270MHz

TXC P/N : 7V27100004

REVISION : S1

PE/RD	QA	MFG
 Robin Huang		
19-Sep-17		

NOTE:

(1)The green product standard set by TXC is based upon the international standards. Related information is publicly described on the TXC's Website, and updated regularly. The document is compliant with the latest green product quality system directives at the time.

(2)Revision "Sx" is for engineering samples only. PE/RD's approval required.

(3)Revision "Ax" is production ready. PE, QA and MFG's approval required

**MSL:Level 1
RoHS Compliant**

Pb used in sealing glass material is exempt from EU directive



<u>Rev</u>	<u>Revise page</u>	<u>Revise contents</u>	<u>Date</u>	<u>Ref.No.</u>	<u>Reviser</u>
S1	N/A	Initial released	19-Sep-17	N/A	Xiaoyan Jiang

Spec Sheet Contents

No.	Content	Page
1	ELECTRICAL SPECIFICATIONS	P.3
2	DIMENSIONS	P.4
3	MARKING	P.4
4	FACTORY LOCATION	P.4
5	SUGGESTED REFLOW PROFILE& MANUAL SOLDER CONDITION	P.4
6	STRUCTURE ILLUSTRATION	P.5
7	EMBOSS CARRIER TAPE & REEL	P.6
8	PACKING	P.7
9	RELIABILITY SPECIFICATIONS	P.8~9

■ ELECTRICAL SPECIFICATIONS

Standard atmospheric conditions

Unless otherwise specified, the standard range of atmospheric conditions for making measurement and tests are as follow:

- Ambient temperature : 25±5°C
- Relative humidity : 40%~70%

If there is any doubt about the results, measurement shall be made within the following limits:

- Ambient temperature : 25±3°C
- Relative humidity : 40%~70%

Measure equipment

Electrical characteristics measured by S&A250B or equivalent.

Crystal cutting type

The crystal is using AT CUT (thickness shear mode).

Unit Weight:

0.018±0.001 g/pcs

	Parameters	SYM.	Electrical Spec.				Notes
			MIN	TYP	MAX	UNITS	
1	Nominal Frequency	FL	27.138270			MHz	-
2	Oscillation Mode	-	Fundamental			-	-
3	Load Capacitance	CL	15			pF	-
4	Frequency Tolerance	-	±20			ppm	at 25 ± 3 °C
5	Frequency Stability	-	±20			ppm	Over Operating Temp. Range (Reference 25°C)
6	Operating Temperature	-	-30	~	85	°C	-
7	Aging	-	±3			ppm	1st Year
8	Drive Level	DL	-	50	-	uW	-
9	Equivalent Resistance Rr	Rr	-	-	50	Ω	-
10	Shunt Capacitance C0	C0	-	-	3	pF	-
11	Insulation Resistance	-	500	-	-	MΩ	at DC 100V
12	Storage Temperature Range	-	-40	~	85	°C	-

■ DIMENSIONS

(Unit:mm)

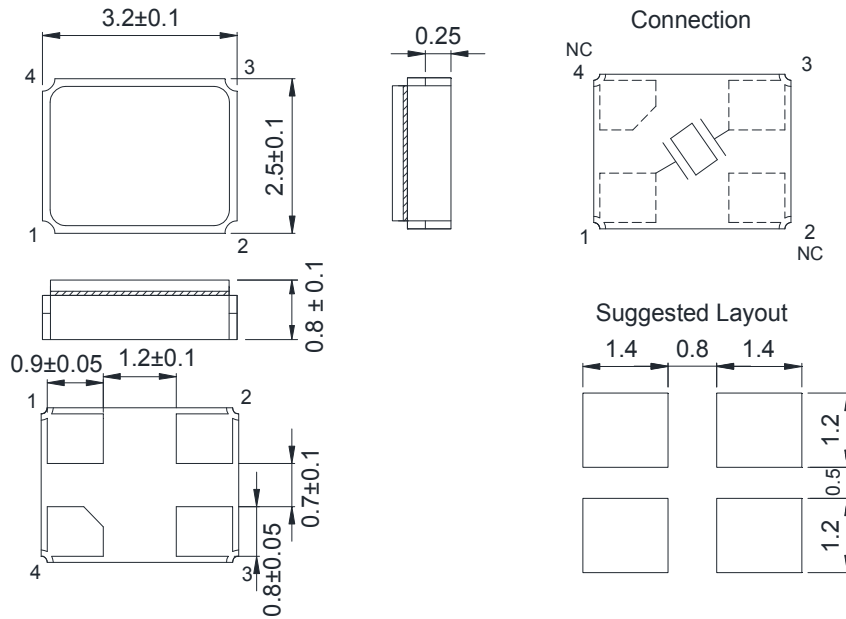

*Coplanarity of solderable areas Camber 0.10 mm Max

■ MARKING

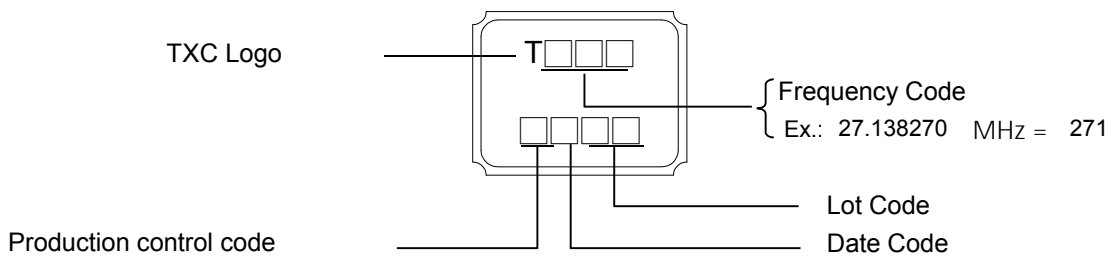

Date Code:

YEAR					MONTH											
					JAN	FEB	MAR	APR	MAY	JUN	JUL	AUG	SEP	OCT	NOV	DEC
2005	2009	2013	2017	2021	A	B	C	D	E	F	G	H	J	K	L	M
2006	2010	2014	2018	2022	N	P	Q	R	S	T	U	V	W	X	Y	Z
2007	2011	2015	2019	2023	a	b	c	d	e	f	g	h	j	k	l	m
2008	2012	2016	2020	2024	n	p	q	r	s	t	u	v	w	x	y	z

*This date code will be cycled every four years

Production Location:China(Ningbo), China(Chungking).

■ SUGGESTED REFLOW PROFILE

Solder melting point :220±10 °C, 60 sec. Min.

Peak Temperature: 260 ± 5 °C, 10 sec. Max.

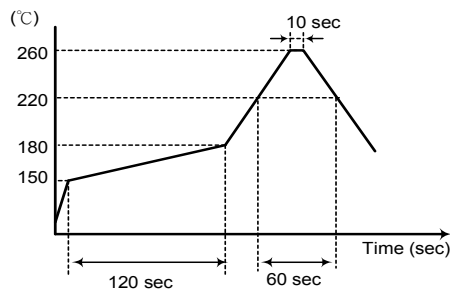

■ SUGGESTED MANUAL SOLDER CONDITION

Temperature: 350 ± 10 °C

Time: 3 sec.

Re-solder times: twice

■ STRUCTURE ILLUSTRATION

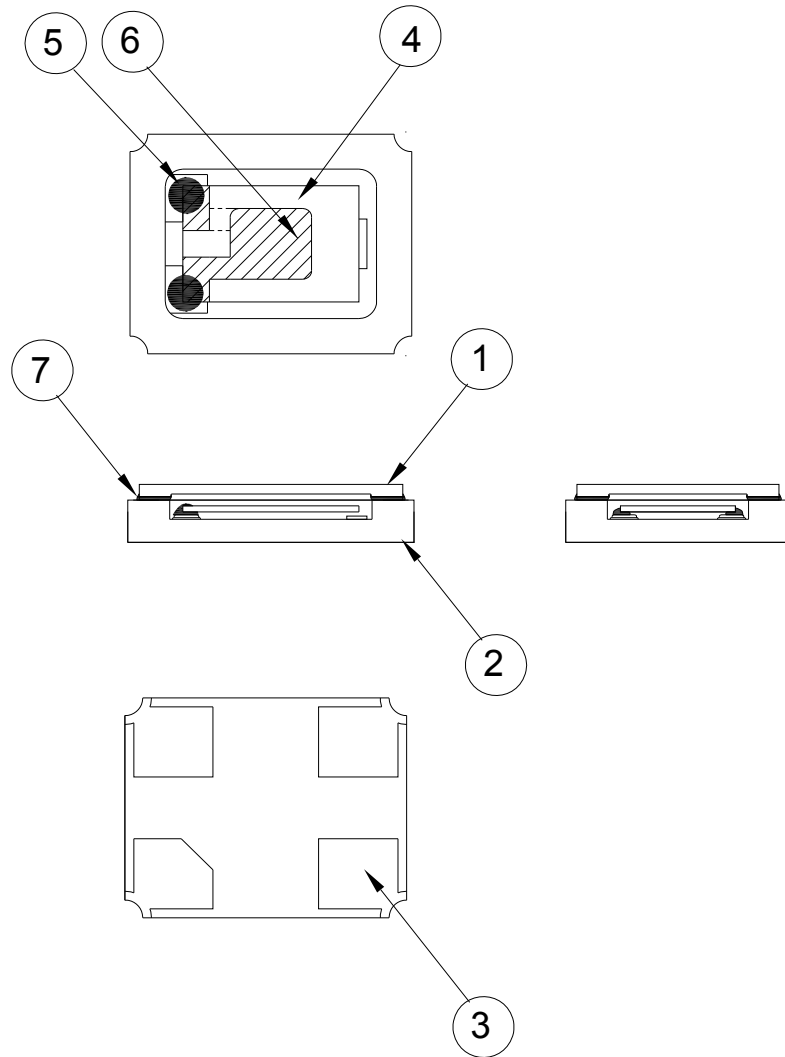

NO	COMPONENTS	MATERIALS	FINISH/SPECIFICATIONS
1	Cap	Ceramic (Al ₂ O ₃)	-
2	Package	Ceramic (Al ₂ O ₃)	-
3	PAD	Au	Tungsten metalize + Ni plating + Au plating
4	Crystal blank	SiO ₂	-
5	Conductive adhesive	Resin+Ag	-
6	Electrode	Ag	-
7	Sealing Glass	Glass(PbO)	-

■ EMBOSS CARRIER TAPE & REEL

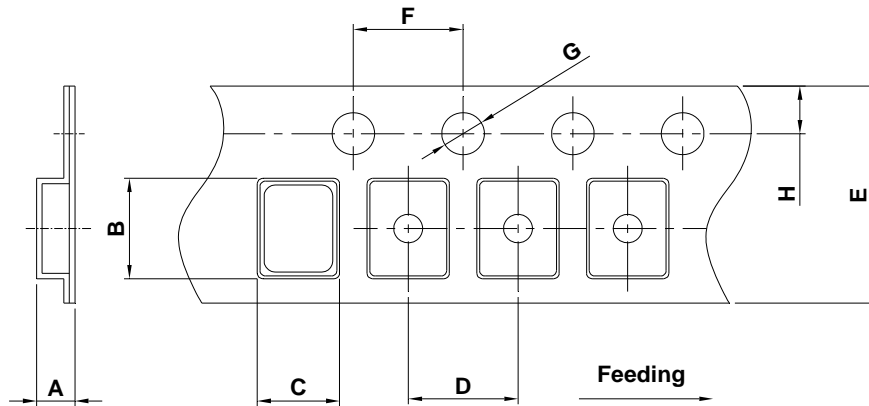

DIMENSIONS	A	B	C	D	E	F	G	H	(UNIT : mm)
	1.65±0.10	3.40±0.10	2.70±0.10	4.00±0.10	8.00±0.20	4.00±0.10	1.55±0.10	1.75±0.10	

REMARK :

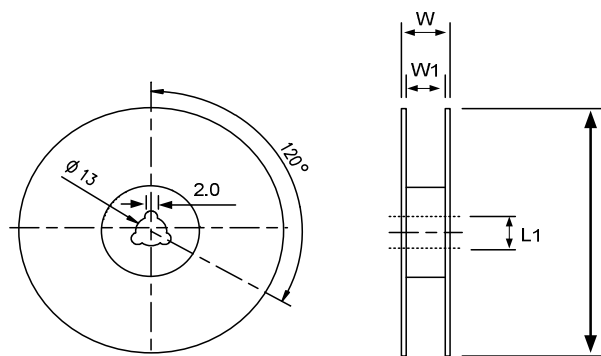
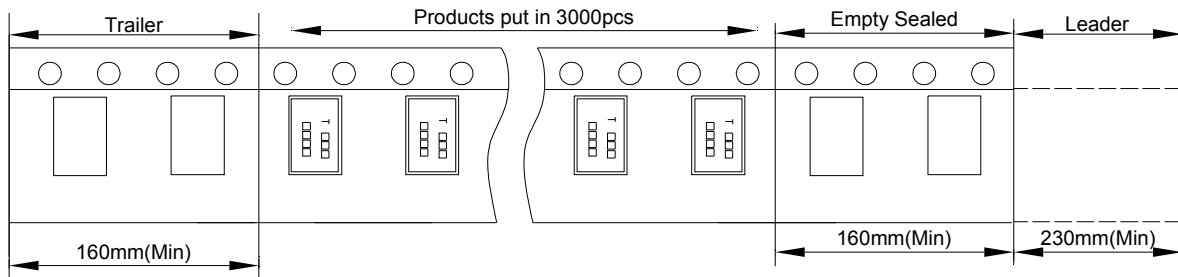

DIMENSIONS	L	L1	W	W1	(UNIT : mm)
	178±1.00	13±0.50	11.5±0.20	8±0.10	

PACKING

Reel Quantity :

- 1. Reel X 6 (6 Reels)
- 2. Reel X 12 (12 Reels)
- 3. Reel X 25 (12 Reels + 13 Reels)
- 4. Reel X 50 (12 Reelsx2 + 13 Reelsx2)

Box Size:

- 1. L200 X W200 X H140mm
- 2. L200 X W200 X H250mm
- 3. L400 X W200 X H250mm
- 4. L400 X W400 X H280mm

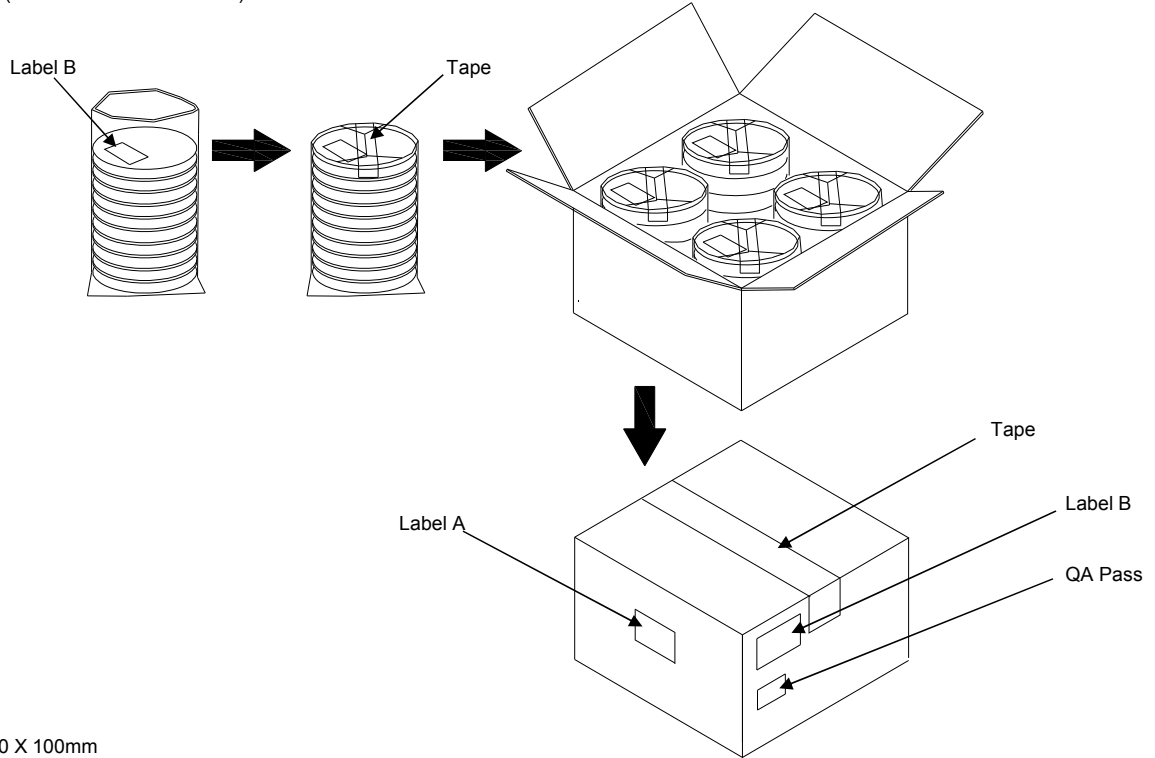

(Label A) Size:100 X 100mm

TXC
Inv No: 00096815
Po No: 21106326- 24- 1
Part No: □□□□□□□□
Qty: 40000 PCS
C/No: 157- 44

(Label B) Size:80 X 40mm

TXC CORPORATION		QA PASS
DATE CODE: □□□□□□□□	QTY: □□□□	2011/09/02
LOT NO: □□□□□□□□	RoHS	
PART NO: □□□□□□□□	HF	
FREQ: □□□□□□□□□□		

[STORAGE]

- 1. Don't be caught in the rain.
- 2. The storage environment shall be 5°C ~40°C temperature and 30% ~ 75%RH humidity and free from the sun shine.
- 3. If customers have special requirements, we can paste labels according to it.

RELIABILITY SPECIFICATIONS
1. Mechanical Endurance

No.	Test Item	Test Methods	Test Criteria
1.1	Drop Test	150 cm height, 3 times on concrete floor .	A . C
1.2	Mechanical Shock	Device are shocked to half sine wave (1000 G) three mutually perpendicular axes each 3 times. 0.5 ms duration time	A . C
1.3	Vibration	Frequency range 10 ~ 2000 Hz Amplitude 1.52 mm/20G Sweep time 20 minutes Perpendicular axes each test time 4 Hrs (Total test time 12 Hrs)	A . C
1.4	Solderability	Temperature 245 °C ± 5°C Immersing depth 0.5 mm minimum Immersion time 5 ± 1 seconds Flux Rosin resin methyl alcohol solvent (1 : 4)	E

2. Environmental Endurance

No.	Test Item	Test Methods	Test Criteria
2.1	Resistance To Soldering Heat	Pre-heat temperature 125 °C Pre-heat time 60 ~ 120 sec. Test temperature 260 ± 5 °C Test time 10 ± 1 sec.	B . C . D
2.2	High Temp. Storage	+ 125 °C ± 3 °C for 500 ± 12 Hrs	B . C . D
2.3	Low Temp. Storage	- 40 °C ± 3 °C for 500 ± 12 Hrs	B . C . D
2.4	Temperature cycle	Total 100 cycles of the following temperature cycle 	B . C . D
2.5	High Temp & Humidity	85°C ± 3°C , RH 85% , 500 Hrs	B . C . D



RELIABILITY SPECIFICATIONS

Specifications	
A	Frequency change: Within ± 5 ppm or in customer's specification.
B	Frequency change: Within ± 10 ppm or in customer's specification.
C	Equivalent series resistance(E.S.R) change: Within $\pm 15\%$ or 10Ω (larger value).
D	After conditioning , quartz crystal units shall be subjected to standard atmospheric conditions for 2 hour, and measured.
E	Minimum 95% of immersed terminal shall be covered with new uniform solder.

Measurement condition

Electrical characteristics measured by S&A250B or equivalent.

X-ON Electronics

Largest Supplier of Electrical and Electronic Components

Click to view similar products for [Crystals category](#):

Click to view products by [TXC Corporation manufacturer](#):

Other Similar products are found below :

[CS325S24000000ABJT](#) [718-13.2-1](#) [MC405 32.0000K-R3:PURE SN](#) [FC-135R 32.7680KF-A3](#) [7A-40.000MAAE-T](#) [7B-27.000MBBK-T](#)
[FL2000085](#) [9B-15.360MBBK-B](#) [9C-7.680MBBK-T](#) [ASH7K-32.768KHZ](#) [AT-41.600MAGQ-T](#) [BTD1062E05A-513](#) [LFXTAL066198Cutt](#)
[9C-14.31818MBBK-T](#) [FA-238 50.0000MB30X-K3](#) [FC-12M 32.7680KA-AC3](#) [SSPT7F-9PF20-R](#) [FX325BS-38.88EEM1201](#)
[LFXTAL065253Cutt](#) [LFXTAL066431Cutt](#) [XT9S20ANA14M7456](#) [XT9SNLANA16M](#) [646G-24-2](#) [7A-24.576MBBK-T](#) [7B-30.000MBBK-T](#)
[WX26-32.768K-6PF](#) [9B-14.31818MBBK-B](#) [CD1AM](#) [7B-25.000MAAE-T](#) [7A-14.31818MBBK-T](#) [6504-202-1501](#) [6526-202-1501](#) [FA-118T](#)
[27.1200MB50P-K0](#) [FC-135R 32.7680KA-A3](#) [ABM12-104-37.400MHZT](#) [ABLS-10.000MHZ-D3W-T](#) [BTJ112E01E-513](#) [BTJ722K01C-7067](#)
[BTL-20-513](#) [TSX-3225 24.0000MF15X-AC](#) [TSX-3225 16.0000MF18X-AC](#) [BTJ120E02C](#) [BTL-12-513](#) [7A-10.000MBBK-T](#) [7A-](#)
[11.0592MBBK-T](#) [ABM12-103-24.000MHZT](#) [CS325S25000000ABJT](#) [ABM3B-25.000MHZ-B2-X-T](#) [FC-135 32.7680KA-A5](#) [FX0800015](#)