



### Features

- > Resistance welded type crystal units.
- > A great number of standard frequencies.
- > Higher frequency pullability and lower equivalent series resistance.
- > Lower cost and highly mass production capability.
- > The best choice of TV, STB, LCDM and Cable Modem.
- > RoHS Compliant / Pb Free

### Electrical Specifications

Item / Type	9B
Frequency Range	3.2 ~ 90 MHz
Frequency Tolerance (at 25 °C)	± 30 ppm, or specify
Frequency Stability Over Operating Temperature Range	± 30 ppm (- 20 ~ +70 °C), or specify
Operating Temperature Range	- 20 ~ +70 °C
Shunt Capacitance (C0)	7 pF Max.
Drive Level	1 ~ 500 μW (100 μW typical)
Load Capacitance	18 pF, or specify
Aging (at 25 °C)	± 3 ppm / year Max.
Storage Temperature Range	- 40 ~ + 85 °C

### Equivalent Series Resistance(ESR)

Fundamental		3rd Overtone	
3.2 ~ 3.686 MHz	200 Ω Max.	27 ~ 30 MHz	100 Ω Max.
3.686 ~ 5 MHz	150 Ω Max.	30 ~ 50 MHz	80 Ω Max.
5 ~ 10 MHz	80 Ω Max.	50 ~ 90 MHz	60 Ω Max.
10 ~ 14 MHz	40 Ω Max.		
14 ~ 30 MHz	30 Ω Max.		

### Dimensions

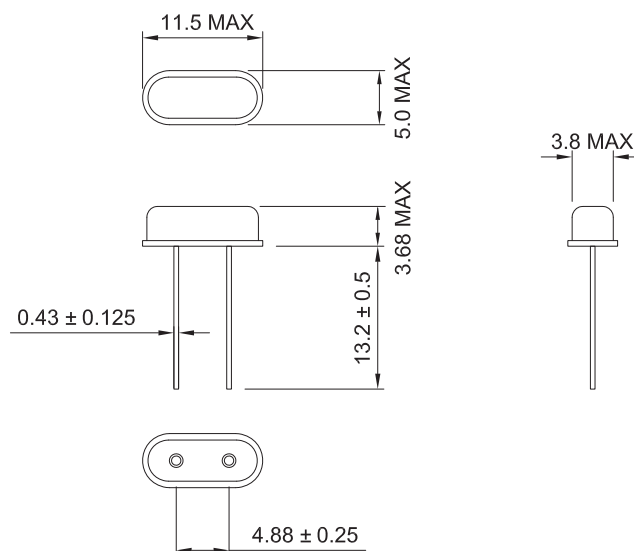

Units:mm

Remark : Specification subject to change without prior notice. Please confirm with our sales.

## X-ON Electronics

Largest Supplier of Electrical and Electronic Components

*Click to view similar products for [Crystals category](#):*

*Click to view products by [TXC Corporation manufacturer](#):*

Other Similar products are found below :

[CS325S24000000ABJT](#) [718-13.2-1](#) [MC405 32.0000K-R3:PURE SN](#) [FC-135R 32.7680KF-A3](#) [7A-40.000MAAE-T](#) [7B-27.000MBBK-T](#)  
[FL2000085](#) [9B-15.360MBBK-B](#) [9C-7.680MBBK-T](#) [ASH7K-32.768KHZ](#) [AT-41.600MAGQ-T](#) [BTD1062E05A-513](#) [LFXTAL066198Cutt](#)  
[9C-14.31818MBBK-T](#) [FA-238 50.0000MB30X-K3](#) [FC-12M 32.7680KA-AC3](#) [SSPT7F-9PF20-R](#) [FX325BS-38.88EEM1201](#)  
[LFXTAL065253Cutt](#) [LFXTAL066431Cutt](#) [XT9S20ANA14M7456](#) [XT9SNLANA16M](#) [646G-24-2](#) [7A-24.576MBBK-T](#) [7B-30.000MBBK-T](#)  
[WX26-32.768K-6PF](#) [9B-14.31818MBBK-B](#) [CD1AM](#) [7B-25.000MAAE-T](#) [7A-14.31818MBBK-T](#) [6504-202-1501](#) [6526-202-1501](#) [FA-118T](#)  
[27.1200MB50P-K0](#) [FC-135R 32.7680KA-A3](#) [ABM12-104-37.400MHZT](#) [ABLS-10.000MHZ-D3W-T](#) [BTJ112E01E-513](#) [BTJ722K01C-7067](#)  
[BTL-20-513](#) [TSX-3225 24.0000MF15X-AC](#) [TSX-3225 16.0000MF18X-AC](#) [BTJ120E02C](#) [BTL-12-513](#) [7A-10.000MBBK-T](#) [7A-](#)  
[11.0592MBBK-T](#) [ABM12-103-24.000MHZT](#) [CS325S25000000ABJT](#) [ABM3B-25.000MHZ-B2-X-T](#) [FC-135 32.7680KA-A5](#) [FX0800015](#)