



Features

- > Resistance welded type crystal units.
- > A great number of standard frequencies.
- > Higher frequency pullability and lower equivalent series resistance.
- > Lower cost and highly mass production capability.
- > The best choice of TV, STB, LCDM and Cable Modem.
- > RoHS Compliant / Pb Free

Electrical Specifications

Item / Type	9B
Frequency Range	3.2 ~ 90 MHz
Frequency Tolerance (at 25 °C)	± 30 ppm, or specify
Frequency Stability Over Operating Temperature Range	± 30 ppm (- 20 ~ +70 °C), or specify
Operating Temperature Range	- 20 ~ +70 °C
Shunt Capacitance (C0)	7 pF Max.
Drive Level	1 ~ 500 μW (100 μW typical)
Load Capacitance	18 pF, or specify
Aging (at 25 °C)	± 3 ppm / year Max.
Storage Temperature Range	- 40 ~ + 85 °C

Equivalent Series Resistance(ESR)

Fundamental		3rd Overtone	
3.2 ~ 3.686 MHz	200 Ω Max.	27 ~ 30 MHz	100 Ω Max.
3.686 ~ 5 MHz	150 Ω Max.	30 ~ 50 MHz	80 Ω Max.
5 ~ 10 MHz	80 Ω Max.	50 ~ 90 MHz	60 Ω Max.
10 ~ 14 MHz	40 Ω Max.		
14 ~ 30 MHz	30 Ω Max.		

Dimensions

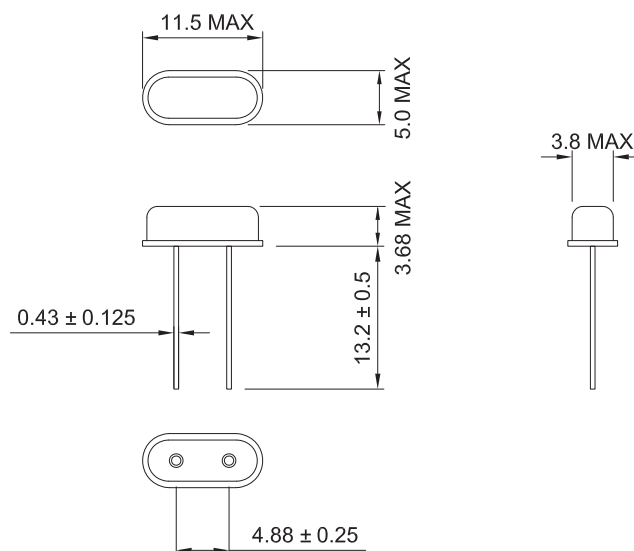

Units:mm

Remark : Specification subject to change without prior notice. Please confirm with our sales.

X-ON Electronics

Largest Supplier of Electrical and Electronic Components

Click to view similar products for [Crystals](#) category:

Click to view products by [TXC Corporation](#) manufacturer:

Other Similar products are found below :

[MC405 32.0000K-R3:PURE SN](#) [7B-27.000MBBK-T](#) [MP1-8.0 99-BU](#) [9B-15.360MBBK-B](#) [PTX-A2JM-10.000M](#) [9C-7.680MBBK-T](#) [H10S-12.000-18-EXT-TR](#) [R38-32.768-12.5-5PPM-NPB](#) [BTD1062E05A-513](#) [21U15A-21.4MHZ](#) [RTX-781DF1-S-20.950](#) [LFXTAL066198Cutt](#) [9C-14.31818MBBK-T](#) [A-11.000MHZ-27](#) [SPT2A-.032768B](#) [SPT2A.032768G](#) [SSPT7F-9PF20-R](#) [FX325BS-38.88EEM1201](#) [MP-1-25.000MHZ-3L](#) [MP-1-6.000MHZ](#) [LFXTAL065253Cutt](#) [LFXTAL066431Cutt](#) [XT9S20ANA14M7456](#) [XT9SNLANA16M](#) [646G-24-2](#) [7B-30.000MBBK-T](#) [6504-202-1501](#) [6526-202-1501](#) [BTJ120E02C](#) [SG636PCE-20.000MC](#) [3404](#) [CM315D32768EZFT](#) [C1E-24.000-7-2020-R](#) [C1E-19.200-12-1530-X-R](#) [C1E-16.000-12-1530-X-R](#) [ABM11-16.000MHZ-9-B1U-T](#) [FL5000014](#) [EUCA18-3.1872M](#) [425F35E027M0000](#) [17196](#) [MS3V-T1R-32.768kHz-7pF-20PPM-TA-QC-Au](#) [VXM7-1C1-16M000](#) [MS1V-T1K-32.768kHz-10pF-20PPM-TA-QC-Au](#) [MS1V-T1K-32.768kHz-12.5pF-20PPM-TA-QC-Au](#) [MS3V-T1R-32.768kHz-9pF-20PPM-TA-QC-Au](#) [17000](#) [17301](#) [16875](#) [ECS-80-18-30B-JEM-TR](#)