

# SPECIFICATION FOR APPROVAL

CN: 1308000943

CUSTOMER : \_\_\_\_\_

PRODUCT TYPE : SMD GLASS SEALING X'TAL 3.2\*2.5

NOMINAL FREQ. : 55.466670MHz

TXC P/N : AV55400003

REVISION : S1

CUSTOMER P/N : \_\_\_\_\_

PM / SALES : \_\_\_\_\_

DATE : \_\_\_\_\_

CUSTOMER SIGNATURE & Date \_\_\_\_\_

- (1) TXC requires one copy returned with signature and title of authorized individual that signifies acceptance of the attached specifications.
- (2) Orders received and accepted by TXC after return of signed copy of specification will be produced per these specifications.
- (3) Any changes to these specifications must be agreed upon by both parties and new revision of the Product Specification Sheet will be issued.
- (4) Any issuance of purchase order prior to consigning back the Approval page of "Specification Sheets" from customers will be regarded as the agreement on the contents of these specifications.

**MSL:Level 1  
RoHS Compliant**

Pb used in sealing glass material is exempt from EU directive

# PRODUCT SPECIFICATION SHEET

CN: 1308000943

PRODUCT TYPE : SMD GLASS SEALING X'TAL 3.2\*2.5

NOMINAL FREQ. : 55.466670MHz

TXC P/N : AV55400003

REVISION : S1

PE/RD	QA	MFG
<i>Shih-Yung Pao</i> Shih-Yung Pao		
<i>16-Aug-13</i>		

## NOTE:

- (1)Lead Free Products are "Directive 2002/95/EC of The European Parliament of 27 January 2003 on the restriction of the use of certain hazardous substances (RoHS) in electrical and electronic equipment" Compliant (Attachment: SGS Test Report).
- (2)Revision "Sx" is for engineering samples only. PE/RD's approval required.
- (3)Revision "Ax" is production ready. PE, QA and MFG's approval required

**MSL:Level 1  
RoHS Compliant**

Pb used in sealing glass material is exempt from EU directive



## Spec Sheet Contents

No.	Content	Page
1	ELECTRICAL SPECIFICATIONS	P.3
2	FACTORY LOCATION	P.3
3	DIMENSIONS	P.4
4	MARKING	P.4
5	SUGGESTED REFLOW PROFILE& MANUAL SOLDER CONDITION	P.4
6	STRUCTURE ILLUSTRATION	P.5
7	EMBOSS CARRIER TAPE & REEL	P.6
8	PACKING	P.7
9	RELIABILITY SPECIFICATIONS	P.8~9

## ■ ELECTRICAL SPECIFICATIONS

### Standard atmospheric conditions

Unless otherwise specified, the standard range of atmospheric conditions for making measurement and tests are as follow:

Ambient temperature : 25±5°C  
 Relative humidity : 40%~70%

If there is any doubt about the results, measurement shall be made within the following limits:

Ambient temperature : 25±3°C  
 Relative humidity : 40%~70%

### Measure equipment

Electrical characteristics measured by S&A250B or equivalent.

### Crystal cutting type

The crystal is using AT CUT (thickness shear mode).

### Unit Weight:

0.018±0.001 g/pcs

	Parameters	SYM.	Electrical Spec.				Notes
			MIN	TYP	MAX	UNITS	
1	Nominal Frequency	FL	55.466670			MHz	-
2	Oscillation Mode	-	Fundamental			-	-
3	Load Capacitance	CL	9			pF	-
4	Frequency Tolerance	-	±25			ppm	at 25 °C ± 3 °C
5	Frequency Stability	-	±30			ppm	Over Operating Temp. Range (Reference 25°C)
6	Operating Temperature	-	-40	~	85	°C	-
7	Aging	-	±5			ppm	1st Year
8	Drive Level	DL	-	10	-	uW	-
9	Series Resonant Resistance	Rr	-	-	30	Ω	-
10	Shunt Capacitance	C0	-	-	2	pF	-
11	Insulation Resistance	-	500	-	-	MΩ	at DC 100V
12	Storage Temperature Range	-	-40	~	150	°C	-

## ■ FACTORY LOCATION

TXC (NINGBO) CORPORATION  
 NO.189 Huang Shan West Road, Beilun District,  
 Ningbo Zhejiang China

**■ DIMENSIONS**

(Unit:mm)

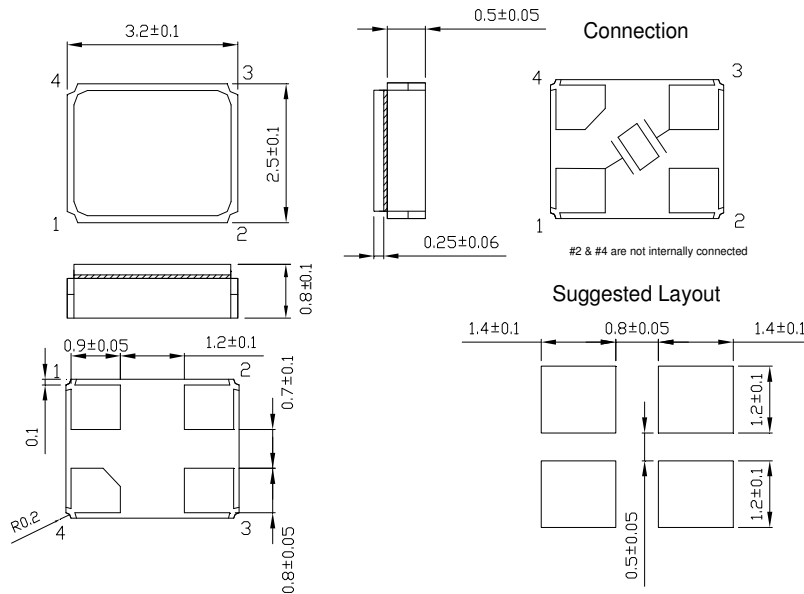

\*Coplanarity of solderable areas Camber 0.10 mm Max

**■ MARKING**

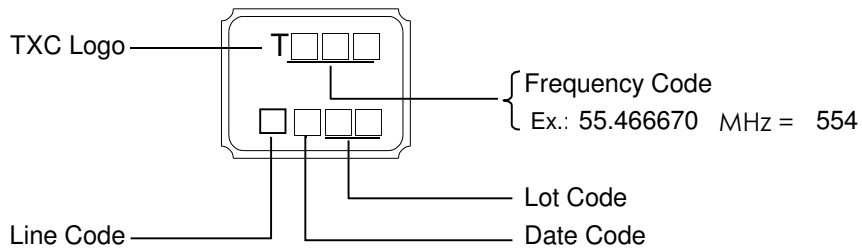

**Date Code:**

YEAR \ MONTH				MONTH											
				JAN	FEB	MAR	APR	MAY	JUN	JUL	AUG	SEP	OCT	NOV	DEC
2005	2009	2013	2017	A	B	C	D	E	F	G	H	J	K	L	M
2006	2010	2014	2018	N	P	Q	R	S	T	U	V	W	X	Y	Z
2007	2011	2015	2019	a	b	c	d	e	f	g	h	j	k	l	m
2008	2012	2016	2020	n	p	q	r	s	t	u	v	w	x	y	z

\*This date code will be cycled every four years

**■ SUGGESTED REFLOW PROFILE**

Solder melting point :220±10 °C, 60 sec. Min.

Peak Temperature: 260 ± 5 °C, 10 sec. Max.

**■ SUGGESTED MANUAL SOLDER CONDITION**

Temperature: 350 ± 10 °C

Time: 3 sec.

Re-solder times: twice

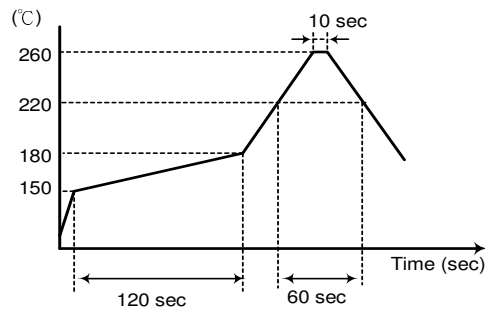

■ STRUCTURE ILLUSTRATION

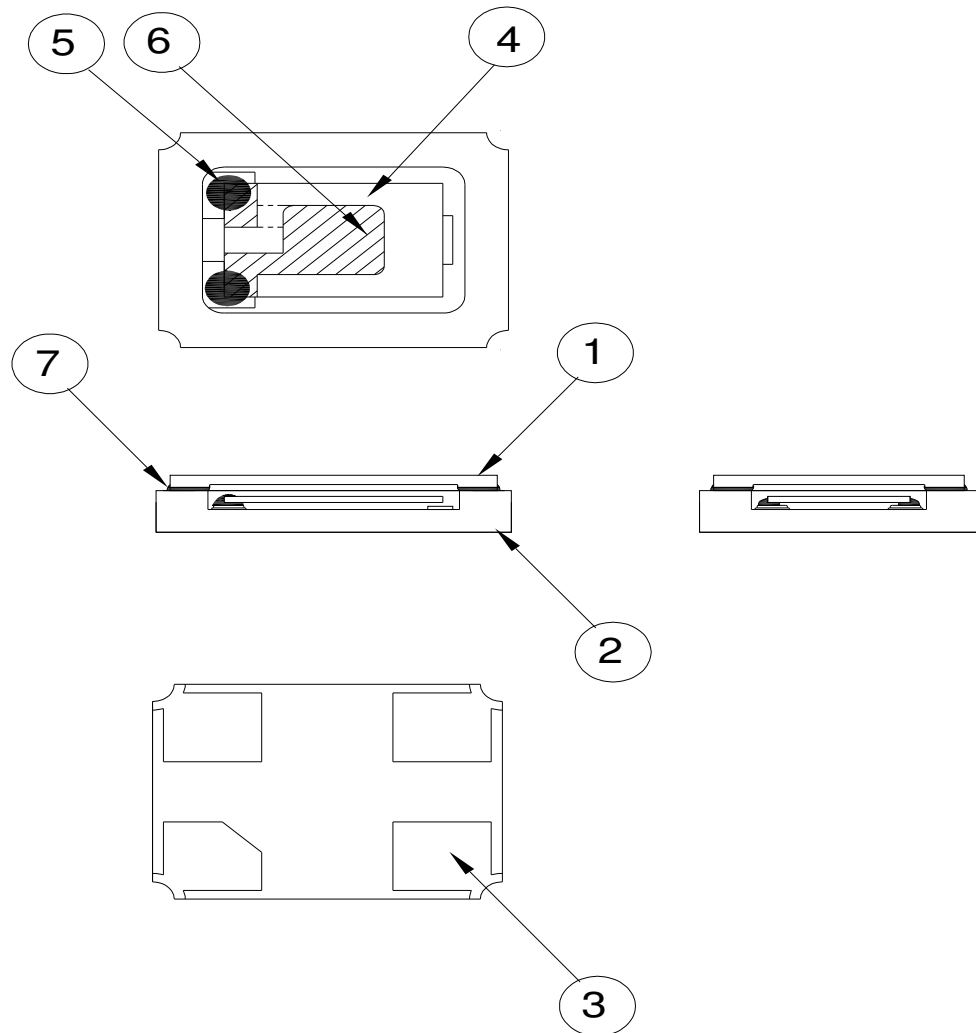

NO	COMPONENTS	MATERIALS	FINISH/SPECIFICATIONS
1	Cap	Ceramic (Al <sub>2</sub> O <sub>3</sub> )	-
2	Package	Ceramic (Al <sub>2</sub> O <sub>3</sub> )	-
3	PAD	Au	Tungsten metalize + Ni plating + Au plating
4	Crystal blank	SiO <sub>2</sub>	-
5	Conductive adhesive	Resin+Ag	-
6	Electrode	Noble Metal	-
7	Sealing Glass	Glass(PbO)	-

■ **EMBOSS CARRIER TAPE & REEL**

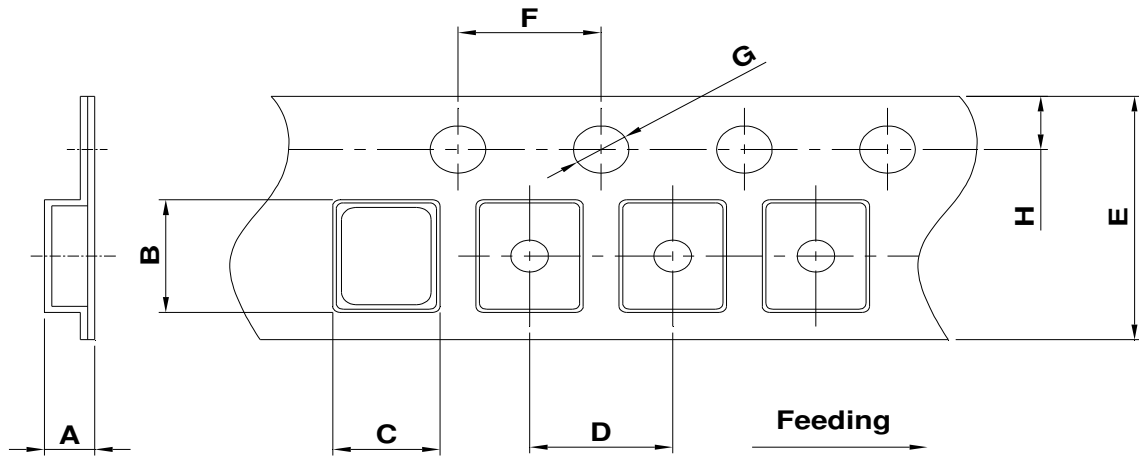

DIMENSIONS	A	B	C	D	E	F	G	H	
	1.65±0.10	3.40±0.10	2.70±0.10	4.00±0.10	8.00±0.20	4.00±0.10	1.55±0.10	1.75±0.10	(UNIT : mm)

REMARK :

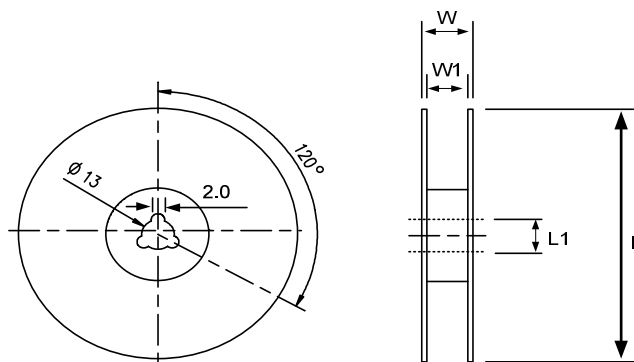
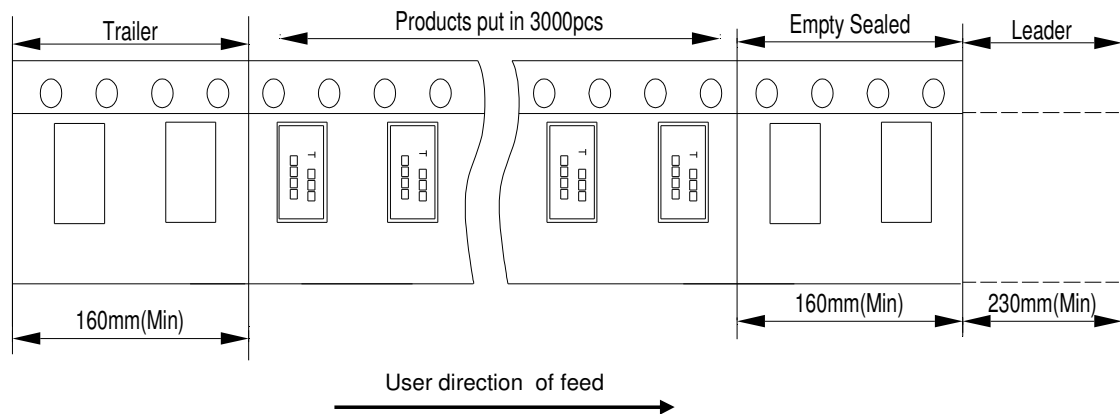

DIMENSIONS	L	L1	W	W1	
	178±1.00	13±0.50	11.5±0.20	8±0.10	(UNIT : mm)



**PACKING**

Reel Quantity :

- 1. Reel X 6 (6 Reels)
- 2. Reel X 12 (12 Reels)
- 3. Reel X 25 (12 Reels + 13 Reels)
- 4. Reel X 50 (12 Reelsx2 + 13 Reelsx2)

Box Size:

- 1. L200 X W200 X H140mm
- 2. L200 X W200 X H250mm
- 3. L400 X W200 X H250mm
- 4. L400 X W400 X H280mm

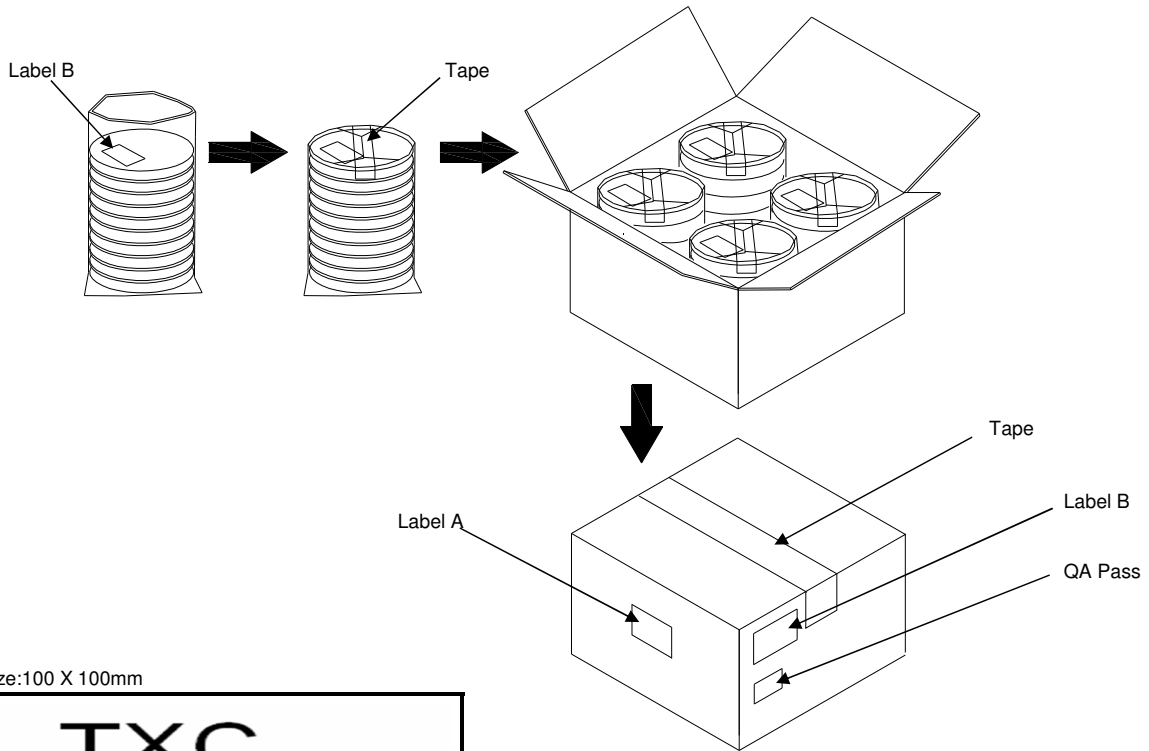

(Label A) Size:100 X 100mm

<h1 style="margin: 0;">TXC</h1>	
Inv No: 00096815	
Po No: 21106326- 24- 1	
Part No: <span style="font-family: monospace;">□□□□□□□□</span>	
Qty: 40000 PCS	
C/No: 157- 44	

(Label B) Size:80 X 40mm

TXC CORPORATION		QA PASS
DATE CODE:	QTY:	2011/09/02
<span style="font-family: monospace;">□□□□□□□□</span>		<span style="font-family: monospace;">□□□□</span>
LOT NO:	<b>RoHS</b>	
<span style="font-family: monospace;">□□□□□□□□</span>		
PART NO:	<b>HF</b>	
<span style="font-family: monospace;">□□□□□□□□</span>		
FREQ: <span style="font-family: monospace;">□□□□□□□□</span>		

**[STORAGE]**

- 1.The storage time to be 1 year maximum.
- 2.Don't be caught in the rain.
- 3.The storage environment shall be 5°C ~40°C temperature and 30% ~ 75%RH humidity and free from the sun shine.
- 4.If customers have special requirements, we can paste labels according to it.

**■ RELIABILITY SPECIFICATIONS (Conforms to AEC-Q200)**

1. Mechanical Endurance

No.	Test Item	Test Methods	Test Criteria
1.1	Mechanical Shock	2000 G , 0.3 m Sec. ,3 times for all 3 directions.	B C
1.2	Vibration	Frequency range 10 ~ 2000 Hz Acceleration 20G Amplitude 1.52mm Sweep time 20 minute Ppendicular axes each test time 4 hours (Total test time 12 hours)	B C
1.3	Terminal Strength	17.7N force for 60sec +/-1sec.	F
1.4	Board Flex	Duration time:60 Sec Minimum,Deviation:3mm	B C
1.5	Solderability	Temperature 245 °C +/- 5°C Immersing depth 0.5 mm minimum Immersion time 5 +/- 0.5 seconds Flux Rosin resin methyl alcohol solvent ( 1 : 4 )	E

2. Environmental Endurance

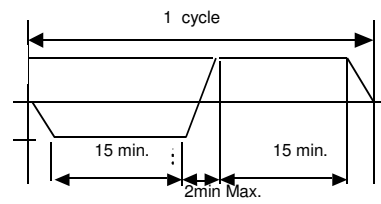
No.	Test Item	Test Methods	SPEC
2.1	Resistance To Soldering Heat	Test temperature 260 +/- 5 °C Test time 10 +/- 1 sec.	BCD
2.2	High Temp. Storage	+ 85°C ± 3 °C for 1000 ± 12 Hrs	BCD
2.3	Low Temp. Storage	- 40 °C ± 3 °C for 1000 ± 12 Hrs	BCD
2.4	Temperature cycle	-40°C ~85°C, for 1000 cycles. 	BCD
2.5	Operational Life	1000 hrs @ 85± 3°C. Rated VDD applied with 1 MΩ.	BCD
2.6	High Temp & Humidity	85°C ± 3°C , RH 85% , 1000 Hrs	BCD

**RELIABILITY SPECIFICATIONS**

Specifications	
A	Frequency change: Within $\pm 5$ ppm or in customer's specification.
B	Frequency change: Within $\pm 10$ ppm or in customer's specification.
C	Equivalent series resistance(E.S.R) change: Within $\pm 15\%$ or $10\Omega$ (larger value).
D	After conditioning , quartz crystal units shall be subjected to standard atmospheric conditions for 24 hour, and measured.
E	Minimum 95% of immersed terminal shall be covered with new uniform solder.
F	No damage on specimen

**Measurement condition**

Electrical characteristics measured by S&A250B or equivalent.

## X-ON Electronics

Largest Supplier of Electrical and Electronic Components

*Click to view similar products for [Crystals category](#):*

*Click to view products by [TXC Corporation manufacturer](#):*

Other Similar products are found below :

[CS325S24000000ABJT](#) [718-13.2-1](#) [MC405 32.0000K-R3:PURE SN](#) [FC-135R 32.7680KF-A3](#) [7A-40.000MAAE-T](#) [7B-27.000MBBK-T](#)  
[FL2000085](#) [9B-15.360MBBK-B](#) [9C-7.680MBBK-T](#) [ASH7K-32.768KHZ](#) [AT-41.600MAGQ-T](#) [BTD1062E05A-513](#) [LFXTAL066198Cutt](#)  
[9C-14.31818MBBK-T](#) [FA-238 50.0000MB30X-K3](#) [FC-12M 32.7680KA-AC3](#) [SSPT7F-9PF20-R](#) [FX325BS-38.88EEM1201](#)  
[LFXTAL065253Cutt](#) [LFXTAL066431Cutt](#) [XT9S20ANA14M7456](#) [XT9SNLANA16M](#) [646G-24-2](#) [7A-24.576MBBK-T](#) [7B-30.000MBBK-T](#)  
[WX26-32.768K-6PF](#) [9B-14.31818MBBK-B](#) [CD1AM](#) [7B-25.000MAAE-T](#) [7A-14.31818MBBK-T](#) [6504-202-1501](#) [6526-202-1501](#) [FA-118T](#)  
[27.1200MB50P-K0](#) [FC-135R 32.7680KA-A3](#) [ABM12-104-37.400MHZT](#) [ABLS-10.000MHZ-D3W-T](#) [BTJ112E01E-513](#) [BTJ722K01C-7067](#)  
[BTL-20-513](#) [TSX-3225 24.0000MF15X-AC](#) [TSX-3225 16.0000MF18X-AC](#) [BTJ120E02C](#) [BTL-12-513](#) [7A-10.000MBBK-T](#) [7A-](#)  
[11.0592MBBK-T](#) [ABM12-103-24.000MHZT](#) [CS325S25000000ABJT](#) [ABM3B-25.000MHZ-B2-X-T](#) [FC-135 32.7680KA-A5](#) [FX0800015](#)