

REV	LOCATIONS	DESCRIPTION	DATE	REVISER	APPD

Note:

1. 10 sprocket hole cumulative tolerance±0.2
2. Carrier camber is within 1.0mm in 100mm
3. Material: Black Conductive polystyrene Alloy 100% recyclable
4. All dimensions meet EIA-481-B requirements
5. Peel off force of cover tape&carrier tape:20g~130g(0.2N~1.3N)
6. Component load per 13" reel: 1,000 pcs

Circuits	(n)	A	B	C
4~20	630(16.0)	295(7.50)	—	—
22~52	945(24.0)	453(11.50)	—	—
54~70	1260(32.0)	561(14.25)	1.122(28.50)	—
72~100	1732(44.0)	797(20.25)	1.594(40.50)	—

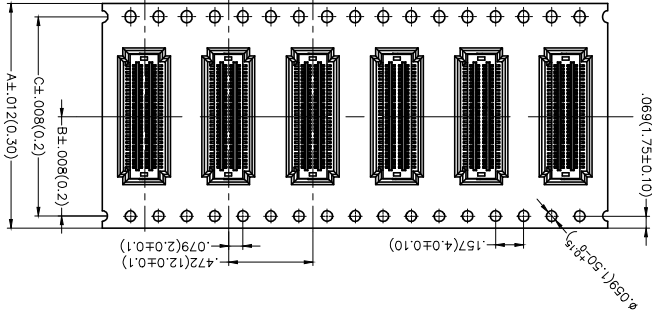
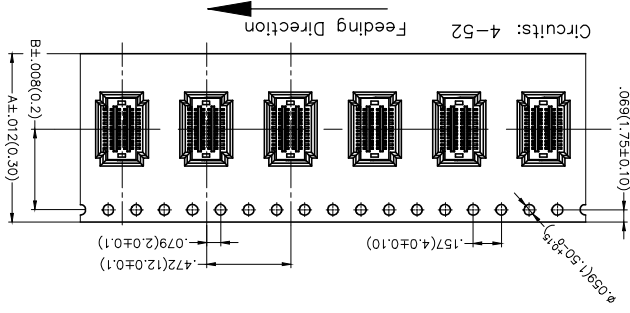
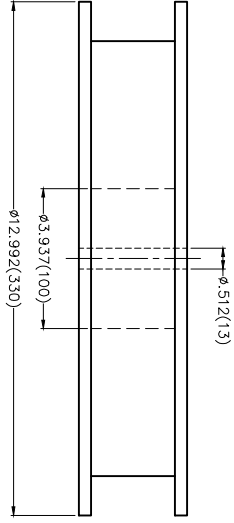
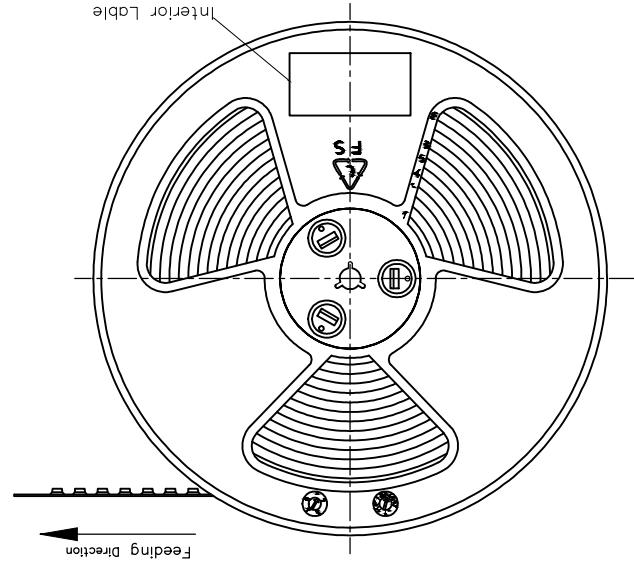
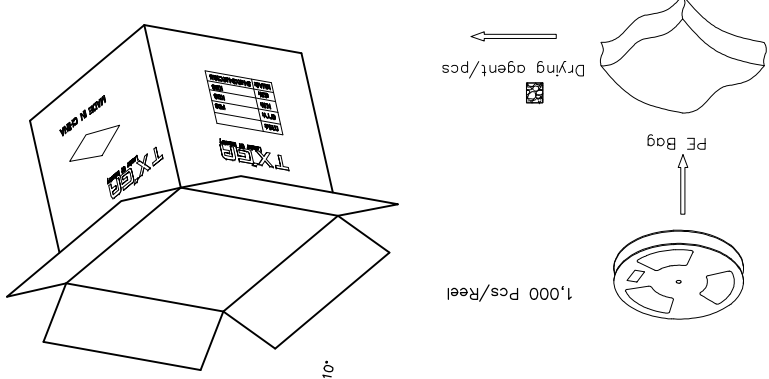
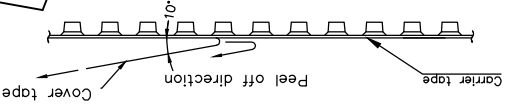
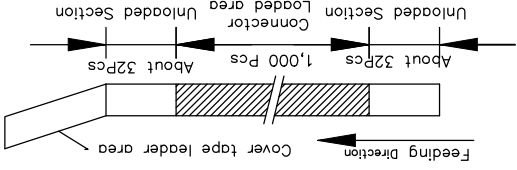

THIRD ANGLE PROJECTION	DESIGN UNITS	X.XX±.012(0.30)	X.XX±.006(0.15)	X.XX±.004(0.10)	X.XX±.0.5
	SCALE	5:1	A4		
GENERAL TOLERANCES (UNLESS SPECIFIED)	APPROVE BY	FRANK	CHECKED BY	CHERRY	DATE
	DATE	05/DEC/19	DATE	05/DEC/19	DATE
PART NO.	ITEM NO.	FBB05002-M	TITLE		
		FBB05002-MXXS1XX3XXMHXX	Board to Board Pitch 0.5mm 180° Vertical (SMT)		
REVISION	REV 3	SHEET NO. 3/3	THIS DRAWING CONTAINS INFORMATION THAT IS PROPRIETARY TO TXGA INDUSTRIAL ELECTRONICS(S)Z)CO.,LTD AND SHOULD NOT BE USED WITHOUT WRITTEN PERMISSION		



A B C D E F

1 2 3 4 5 6 7 8

X-ON Electronics

Largest Supplier of Electrical and Electronic Components

Click to view similar products for [Board to Board & Mezzanine Connectors](#) category:

Click to view products by [TXGA](#) manufacturer:

Other Similar products are found below :

[10135583-642402LF](#) [89885-310LF](#) [589158040000018](#) [6-1393048-0](#) [68683-613](#) [MDF7-12DP-2.54DSA](#) [MDF7-18P-2.54DSA\(01\)](#) [MDF7-20DP-2.54DSA](#) [MDF7-26D-2.54DSA\(55\)](#) [MDF7-3P-2.54DSA\(01\)](#) [MDF7B-20P-2.54DSA\(01\)](#) [MDF7B-3P-2.54DSA\(55\)](#) [MDF7C-11P-2.54DSA\(55\)](#) [MDF7C-18P-2.54DSA\(55\)](#) [MDF7C-5P-2.54DSA\(01\)](#) [MDF7P-5P-2.54DSA\(55\)](#) [75234-0516](#) [FCN-230C068-11](#) [FCN-268F012-G/BD](#) [FCN-268F036-G/BD](#) [FCN-268M012-G/0D](#) [FCN-268M024-G/1D](#) [FCN-360C008-C](#) [FCN-360C040-C](#) [FCN-723J004/1](#) [MIS-048-01-F-D-DP-K](#) [832-10-034-10-001000](#) [93696-325LF](#) [11828-1FA](#) [AXK630345P](#) [18097-0013](#) [ICA-328STT](#) [2007042-2](#) [304400-2](#) [FCN-214Q030-G/0](#) [FCN-215Q040-G/0](#) [FCN-230C068-ESA](#) [FCN-234P048-G/0](#) [FCN-235D050-G/C](#) [FCN-360A3](#) [FCN-360C040-B](#) [210-93-314-41-105000](#) [2-22603-0](#) [379-064-521-202](#) [MDF7-12P-2.54DSA\(01\)](#) [MDF7-16P-2.54DS\(56\)](#) [MDF7-40DP-2.54DSA\(55\)](#) [MDF7-8P-2.54DSA\(55\)](#) [MDF7B-16P-2.54DSA\(55\)](#) [AXG720047](#)