

REV	LOCATIONS	DESCRIPTION	DATE	REVISED	APPD

SPECIFICATIONS

Electrical
 Current Rating: 0.5A AC(rms)/DC
 Voltage Rating: 50V AC(rms)/DC
 Contact Resistance: 20 mΩ Max
 Insulation Resistance: 500 MΩ MIN
 Withstanding Voltage: 200V AC r.m.s
 Temperature Range-Operating: -40°C~+85°C

Material and Plating
 Housing: Heat Resistant Polymer UL 94V-0
 Actuator: Heat Resistant Polymer UL 94V-0
 Contact: Phosphor Bronze/ Tin Plated
 Stopper: Phosphor Bronze/ Tin Plated

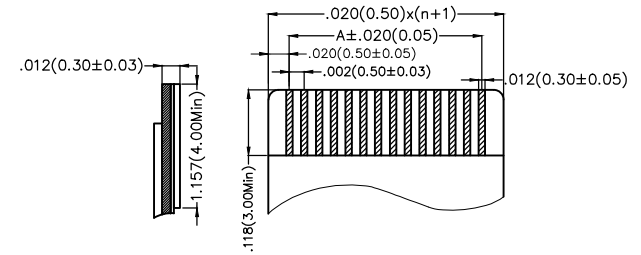
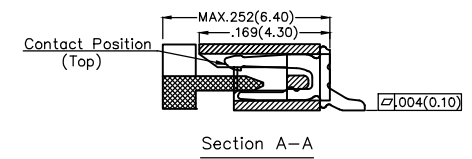
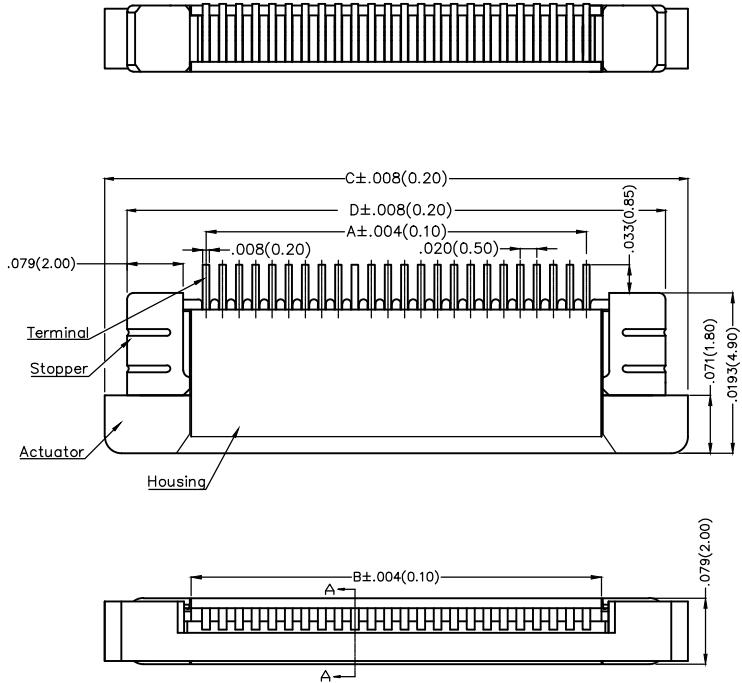

Ordering Information

FFC 050 01 — XX S B A 1 X 4 W5 M
 1 2 3 4 5 6 7 8 9 10 11 12

1 Category FFC-FPC	2 Series Number 050-Pitch 0.50mm	3 Distinction No. 01	4 Circuits XX	5 Assemble Layout S-SMT	6 Entry Angle B- 90° Angle
7 Contact Position A-Top	8 ZIF 1-ZIF	9 Plating 2-Tin Plated 1-Gold Plated	10 Material-Resin 4-PA9T	11 Color-Resin W5-Housing: Natural, Actuator: Black	12 Packaging M-Reel

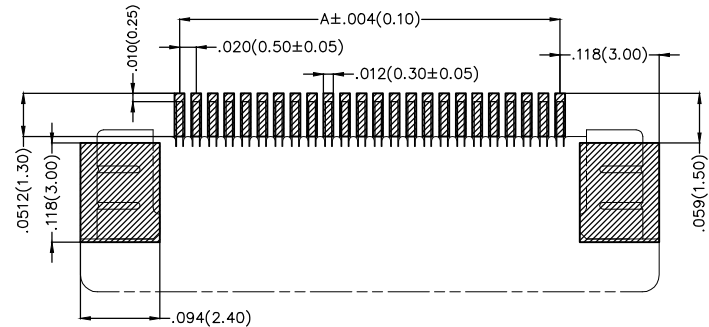

 THIRD ANGLE PROJECTION DESIGN UNITS Inch (metric) SCALE 5:1 SIZE A4	GENERAL TOLERANCES (UNLESS SPECIFIED)		APPROVE BY FRANK	DATE 18/JUN/13	PART NO. FFC05001-XXSBA1X4W5M	ITEM NO. FFC05001	 Leader Of Industry	
	X ± 0.12 (0.30)	X' ± 5'	CHECKED BY JACOB	DATE 18/JUN/13	TITLE FPC/FFC connector 0.5mm Top contact SMT	REV 0		SHEET NO. 1/5
	X.XX ± 0.008 (0.20)	.X' ± 2'	DRAWN BY CHERRY	DATE 18/JUN/13	THIS DRAWING CONTAINS INFORMATION THAT IS PROPRIETARY TO TXGA INDUSTRIAL ELECTRONICS(S.Z)CO.,LTD AND SHOULD NOT BE USED WITHOUT WRITTEN PERMISSION			
	X.XXX ± 0.006 (0.15)	.XX' ± 1'						

1 2 3 4 5 6 7 8

REV	LOCATIONS	DESCRIPTION	DATE	REVISED	APPD

A

A

B

B

C

C

D

D



E

E

F

F

Circuits (n)	Part No.	Dimensions(in/mm)				Circuits (n)	Part No.	Dimensions(in/mm)			
		A	B	C	D			A	B	C	D
4	FFC05001-04SBA1X4W5M	.059(1.50)	.102(2.60)	.295(7.50)	.256(6.50)	20	FFC05001-20SBA1X4W5M	.374(9.50)	.417(10.60)	.610(15.50)	.571(14.50)
5	FFC05001-05SBA1X4W5M	.079(2.00)	.122(3.10)	.315(8.00)	.276(7.00)	21	FFC05001-21SBA1X4W5M	.394(10.00)	.437(11.10)	.630(16.00)	.591(15.00)
6	FFC05001-06SBA1X4W5M	.098(2.50)	.142(3.60)	.335(8.50)	.295(7.50)	22	FFC05001-22SBA1X4W5M	.413(10.50)	.457(11.60)	.650(16.50)	.610(15.50)
7	FFC05001-07SBA1X4W5M	.118(3.00)	.161(4.10)	.354(9.00)	.315(8.00)	24	FFC05001-24SBA1X4W5M	.453(11.50)	.496(12.60)	.690(17.50)	.650(16.50)
8	FFC05001-08SBA1X4W5M	.138(3.50)	.171(4.60)	.374(9.50)	.335(8.50)	25	FFC05001-25SBA1X4W5M	.472(12.00)	.516(13.10)	.709(18.00)	.689(17.00)
9	FFC05001-09SBA1X4W5M	.157(4.00)	.201(5.10)	.394(10.00)	.354(9.00)	26	FFC05001-26SBA1X4W5M	.492(12.50)	.535(13.60)	.729(18.50)	.689(17.50)
10	FFC05001-10SBA1X4W5M	.177(4.50)	.221(5.60)	.413(10.50)	.374(9.50)	27	FFC05001-27SBA1X4W5M	.512(13.00)	.555(14.10)	.748(19.00)	.709(18.00)
11	FFC05001-11SBA1X4W5M	.197(5.00)	.240(6.10)	.433(11.00)	.394(10.00)	28	FFC05001-28SBA1X4W5M	.531(13.50)	.575(14.60)	.768(19.50)	.728(18.50)
12	FFC05001-12SBA1X4W5M	.217(5.50)	.260(6.60)	.452(11.50)	.413(10.50)	29	FFC05001-29SBA1X4W5M	.551(14.00)	.595(15.10)	.787(20.00)	.748(19.00)
13	FFC05001-13SBA1X4W5M	.236(6.00)	.280(7.10)	.472(12.00)	.433(11.00)	30	FFC05001-30SBA1X4W5M	.571(14.50)	.614(15.60)	.807(20.50)	.768(19.50)
14	FFC05001-14SBA1X4W5M	.256(6.50)	.299(7.60)	.492(12.50)	.453(11.50)	32	FFC05001-32SBA1X4W5M	.610(15.50)	.654(16.60)	.846(21.50)	.807(20.50)
15	FFC05001-15SBA1X4W5M	.276(7.00)	.319(8.10)	.512(13.00)	.472(12.00)	33	FFC05001-33SBA1X4W5M	.630(16.00)	.673(17.10)	.866(22.00)	.827(21.00)
16	FFC05001-16SBA1X4W5M	.295(7.50)	.339(8.60)	.531(13.50)	.492(12.50)	34	FFC05001-34SBA1X4W5M	.650(16.50)	.693(17.60)	.886(22.50)	.846(21.50)
17	FFC05001-17SBA1X4W5M	.315(8.00)	.359(9.10)	.551(14.00)	.512(13.00)	35	FFC05001-35SBA1X4W5M	.669(17.00)	.713(18.10)	.905(23.00)	.866(22.00)
18	FFC05001-18SBA1X4W5M	.335(8.50)	.378(9.60)	.571(14.50)	.531(13.50)	36	FFC05001-36SBA1X4W5M	.689(17.50)	.732(18.60)	.925(23.50)	.886(22.50)
19	FFC05001-19SBA1X4W5M	.354(9.00)	.398(10.10)	.591(15.00)	.551(14.00)	40	FFC05001-40SBA1X4W5M	.768(19.50)	.811(20.60)	1.004(25.50)	.965(24.50)

 THIRD ANGLE PROJECTION	GENERAL TOLERANCES (UNLESS SPECIFIED)		APPROVE BY FRANK	DATE 18/JUN/13	PART NO. FFC05001-XXSBA1X4W5M	ITEM NO. FFC05001	 Leader Of Industry
	DESIGN UNITS Inch (metric)	X.±.012(0.30) X.X±.008(0.20) X.XX±.006(0.15) X.XXX±.004(0.10)	X.±5' .X±2' .XX±1' .XXX±0.5'	CHECKED BY JACOB	DATE 18/JUN/13	TITLE FPC/FFC connector 0.5mm Top contact SMT	
SCALE 5:1	SIZE A4	DRAWN BY CHERRY		DATE 18/JUN/13	THIS DRAWING CONTAINS INFORMATION THAT IS PROPRIETARY TO TXGA INDUSTRIAL ELECTRONICS(S.Z)CO.,LTD AND SHOULD NOT BE USED WITHOUT WRITTEN PERMISSION		

1 2 3 4 5 6 7 8

REV	LOCATIONS	DESCRIPTION	DATE	REVISER	APPD

SPECIFICATIONS

Electrical

Current Rating: 0.5A AC(rms)/DC
Voltage Rating: 50V AC(rms)/DC
Contact Resistance: 20 mΩ Max
Insulation Resistance: 500 MΩ MIN
Withstanding Voltage: 200V AC r.m.s
Temperature Range-Operating: -40°C~+85°C

Material and Plating

Housing: Heat Resistant Polymer UL 94V-0
Actuator: Heat Resistant Polymer UL 94V-0
Contact: Phosphor Bronze/ Tin Plated
Stopper: Phosphor Bronze/ Tin Plated

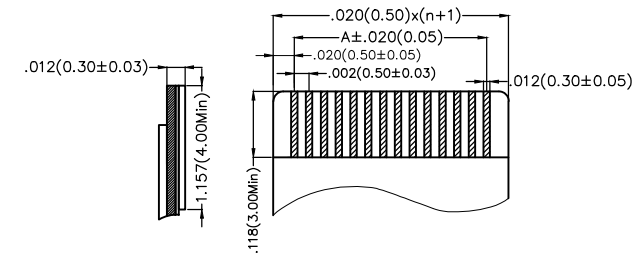

Applicable FFC Recommended Dimension

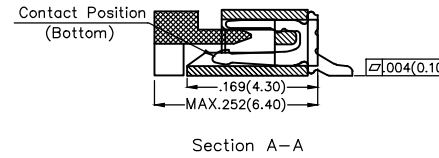

Ordering Information

FFC 050 01 — XX S B B 1 X 4 W5 M
1 2 3 4 5 6 7 8 9 10 11 12

1 Category FFC-FPC	2 Series Number 050-Pitch 0.50mm	3 Distinction No. 01	4 Circuits XX	5 Assemble Layout S-SMT	6 Entry Angle B- 90° Angle
7 Contact Position B-Bottom	8 ZIF 1-ZIF	9 Plating 2-Tin Plated 1-Gold Plated	10 Material-Resin 4-PA9T	11 Color-Resin W5-Housing: Natural, Actuator: Black	12 Packaging M-Reel

 THIRD ANGLE PROJECTION	GENERAL TOLERANCES (UNLESS SPECIFIED)		APPROVE BY FRANK	DATE 18/JUN/13	PART NO. FFC05001-XXSBB1X4W5M	ITEM NO. FFC05001	 Leader Of Industry	
	DESIGN UNITS Inch (metric)	X.±.012(0.30) X.X±.008(0.20) X.XX±.006(0.15) X.XXX±.004(0.10)	X.±5° .X'±2° .XX'±1° .XXX'±0.5°	CHECKED BY JACOB	DATE 18/JUN/13	TITLE FPC/FFC connector 0.5mm Bottom contact SMT		REV 0
SCALE 5:1	SIZE A4		DRAWN BY CHERRY	DATE 18/JUN/13	THIS DRAWING CONTAINS INFORMATION THAT IS PROPRIETARY TO TXGA INDUSTRIAL ELECTRONICS(S.Z)CO.,LTD AND SHOULD NOT BE USED WITHOUT WRITTEN PERMISSION			

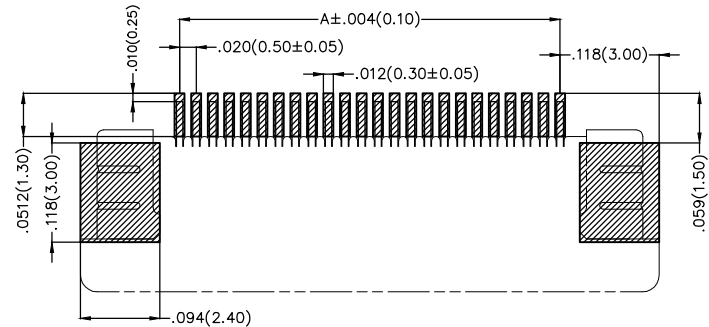
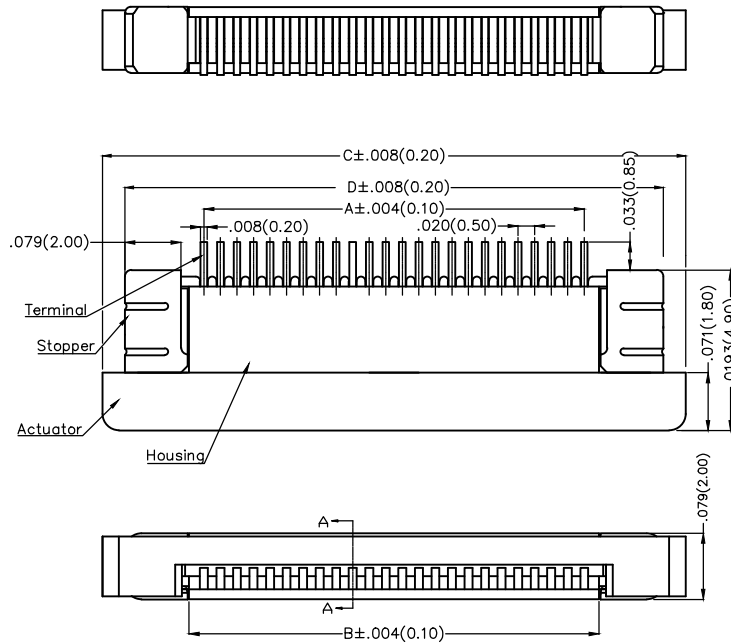

Recommended P.C.Board Layout
General tolerance: ±0.05mm

1 2 3 4 5 6 7 8

REV	LOCATIONS	DESCRIPTION	DATE	REVISER	APPD

A

A

B

B

C

C

D

D



E

E

F

F

Circuits (n)	Part No.	Dimensions(in/mm)				Circuits (n)	Part No.	Dimensions(in/mm)			
		A	B	C	D			A	B	C	D
4	FFC05001-04SBB1X4W5M	.059(1.50)	.102(2.60)	.295(7.50)	.256(6.50)	20	FFC05001-20SBB1X4W5M	.374(9.50)	.417(10.60)	.610(15.50)	.571(14.50)
5	FFC05001-05SBB1X4W5M	.079(2.00)	.122(3.10)	.315(8.00)	.276(7.00)	21	FFC05001-21SBB1X4W5M	.394(10.00)	.437(11.10)	.630(16.00)	.591(15.00)
6	FFC05001-06SBB1X4W5M	.098(2.50)	.142(3.60)	.335(8.50)	.295(7.50)	22	FFC05001-22SBB1X4W5M	.413(10.50)	.457(11.60)	.650(16.50)	.610(15.50)
7	FFC05001-07SBB1X4W5M	.118(3.00)	.161(4.10)	.354(9.00)	.315(8.00)	24	FFC05001-24SBB1X4W5M	.453(11.50)	.496(12.60)	.690(17.50)	.650(16.50)
8	FFC05001-08SBB1X4W5M	.138(3.50)	.171(4.60)	.374(9.50)	.335(8.50)	25	FFC05001-25SBB1X4W5M	.472(12.00)	.516(13.10)	.709(18.00)	.689(17.00)
9	FFC05001-09SBB1X4W5M	.157(4.00)	.201(5.10)	.394(10.00)	.354(9.00)	26	FFC05001-26SBB1X4W5M	.492(12.50)	.535(13.60)	.729(18.50)	.689(17.50)
10	FFC05001-10SBB1X4W5M	.177(4.50)	.221(5.60)	.413(10.50)	.374(9.50)	27	FFC05001-27SBB1X4W5M	.512(13.00)	.555(14.10)	.748(19.00)	.709(18.00)
11	FFC05001-11SBB1X4W5M	.197(5.00)	.240(6.10)	.433(11.00)	.394(10.00)	28	FFC05001-28SBA1X4W5M	.531(13.50)	.575(14.60)	.768(19.50)	.728(18.50)
12	FFC05001-12SBB1X4W5M	.217(5.50)	.260(6.60)	.452(11.50)	.413(10.50)	29	FFC05001-29SBA1X4W5M	.551(14.00)	.595(15.10)	.787(20.00)	.748(19.00)
13	FFC05001-13SBB1X4W5M	.236(6.00)	.280(7.10)	.472(12.00)	.433(11.00)	30	FFC05001-30SBB1X4W5M	.571(14.50)	.614(15.60)	.807(20.50)	.768(19.50)
14	FFC05001-14SBB1X4W5M	.256(6.50)	.299(7.60)	.492(12.50)	.453(11.50)	32	FFC05001-32SBB1X4W5M	.610(15.50)	.654(16.60)	.846(21.50)	.807(20.50)
15	FFC05001-15SBB1X4W5M	.276(7.00)	.319(8.10)	.512(13.00)	.472(12.00)	33	FFC05001-33SBB1X4W5M	.630(16.00)	.673(17.10)	.866(22.00)	.827(21.00)
16	FFC05001-16SBB1X4W5M	.295(7.50)	.339(8.60)	.531(13.50)	.492(12.50)	34	FFC05001-34SBB1X4W5M	.650(16.50)	.693(17.60)	.886(22.50)	.846(21.50)
17	FFC05001-17SBB1X4W5M	.315(8.00)	.359(9.10)	.551(14.00)	.512(13.00)	35	FFC05001-35SBB1X4W5M	.669(17.00)	.713(18.10)	.905(23.00)	.866(22.00)
18	FFC05001-18SBB1X4W5M	.335(8.50)	.378(9.60)	.571(14.50)	.531(13.50)	36	FFC05001-36SBB1X4W5M	.689(17.50)	.732(18.60)	.925(23.50)	.886(22.50)
19	FFC05001-19SBB1X4W5M	.354(9.00)	.398(10.10)	.591(15.00)	.551(14.00)	40	FFC05001-40SBB1X4W5M	.768(19.50)	.811(20.60)	1.004(25.50)	.965(24.50)

 THIRD ANGLE PROJECTION	GENERAL TOLERANCES (UNLESS SPECIFIED)		APPROVE BY FRANK	DATE 18/JUN/13	PART NO. FFC05001-XXSBB1X4W5M	ITEM NO. FFC05001	 Leader Of Industry	
	X.±.012(0.30)	X.±5'	CHECKED BY JACOB	DATE 18/JUN/13	TITLE FPC/FFC connector 0.5mm Bottom contact SMT	REV 0		SHEET NO. 4/5
	DESIGN UNITS Inch (metric)	X.X±.008(0.20)	.X±2'	DRAWN BY CHERRY	DATE 18/JUN/13	THIS DRAWING CONTAINS INFORMATION THAT IS PROPRIETARY TO TXGA INDUSTRIAL ELECTRONICS(S.Z)CO.,LTD AND SHOULD NOT BE USED WITHOUT WRITTEN PERMISSION		
	SCALE 5:1	SIZE A4	X.XX±.006(0.15)	.XX±1'	X.XXX±.004(0.10)	.XXX±0.5'		

1 2 3 4 5 6 7 8

1 2 3 4 5 6 7 8

REV	LOCATIONS	DESCRIPTION	DATE	REVISER	APPD

A
B
C
D
E
F

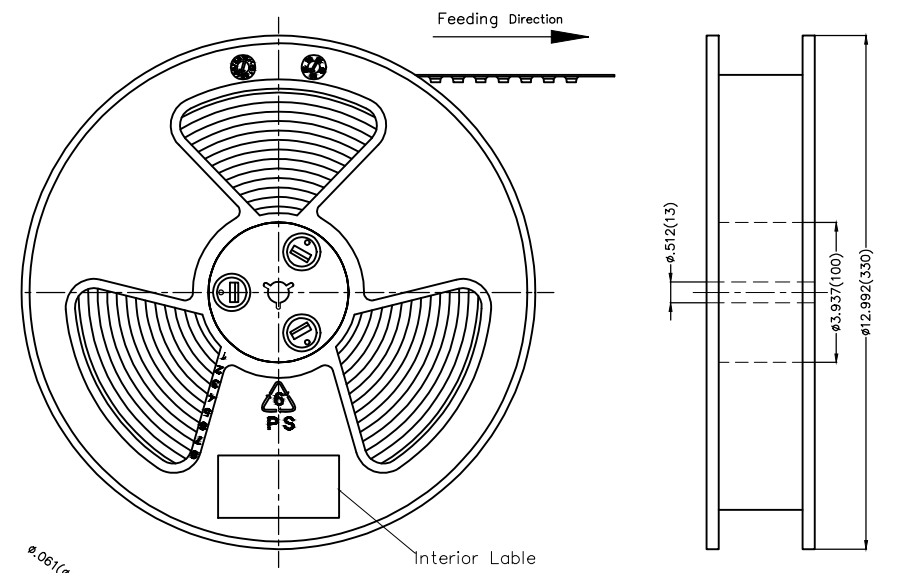

- Note:
1. 10 sprocket hole cumulative tolerance ± 0.2
 2. Carrier camber is within 1.0mm in 250mm
 3. Material: White Conductive polystyrene Alloy 100% recyclable
 4. All dimensions meet EIA-481-3 requirements
 5. Peel off force of cover tape & carrier tape: 20g~130g(0.2N~1.3N)
 6. Component load per 13" reel: 2,000 pcs

Circuits (n)	Dimensions(in/mm)		
	A	B	C
4	.630(16.0)	.295(7.5)	—
5~21	.945(24.0)	.453(11.5)	—
22~32	1.260(32.0)	.561(14.25)	1.033(28.50)
33~40	1.732(44.0)	.797(20.25)	1.594(40.50)

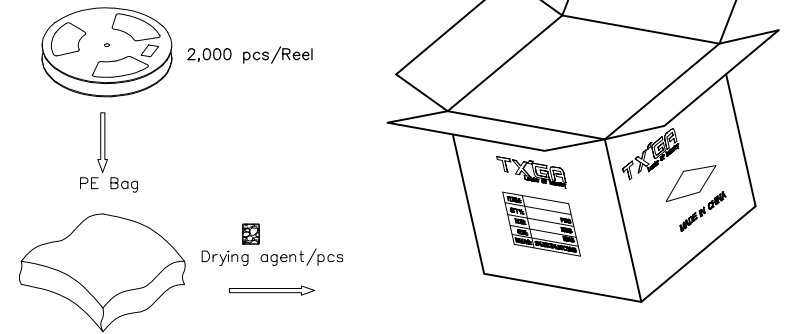
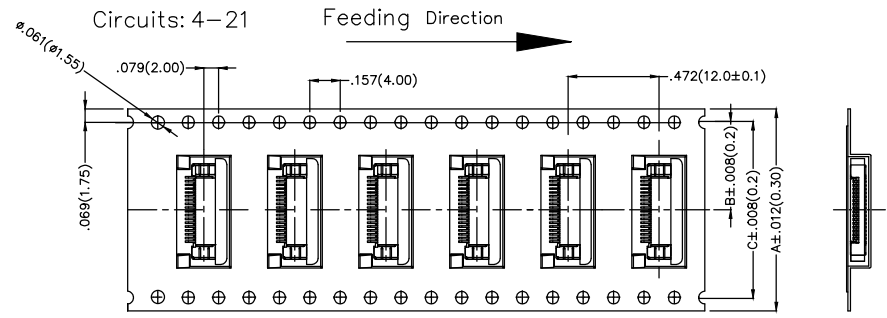
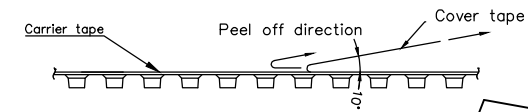
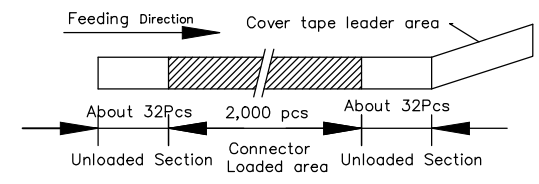
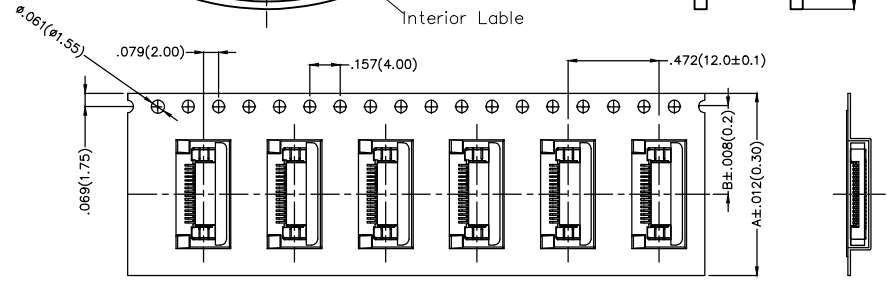

 THIRD ANGLE PROJECTION DESIGN UNITS Inch (metric) SCALE 5:1 SIZE A4	GENERAL TOLERANCES (UNLESS SPECIFIED)		APPROVE BY FRANK	DATE 18/JUN/13	PART NO. FFC05001-XXSBX1X4W5M	ITEM NO. FFC05001	 Leader Of Industry	
	X. \pm .012(0.30)	X. \pm 5'	CHECKED BY JACOB	DATE 18/JUN/13	TITLE FPC/FFC connector 0.5mm SMT			REV 0
	X.X \pm .008(0.20)	.X \pm 2'	DRAWN BY CHERRY	DATE 18/JUN/13	THIS DRAWING CONTAINS INFORMATION THAT IS PROPRIETARY TO TXGA INDUSTRIAL ELECTRONICS(S.Z)CO.,LTD AND SHOULD NOT BE USED WITHOUT WRITTEN PERMISSION			SHEET NO. 5/5
	X.XX \pm .006(0.15)	.XX \pm 1'						

1 2 3 4 5 6 7 8

X-ON Electronics

Largest Supplier of Electrical and Electronic Components

Click to view similar products for [FFC & FPC Connectors](#) category:

Click to view products by [TXGA](#) manufacturer:

Other Similar products are found below :

[00-6200-227-022-800](#) [006205250500825+](#) [006205280500825+](#) [FPH-1602G](#) [FPH-2022G](#) [52610-1275](#) [501864-3091-TR225](#)
[086222026001800](#) [52610-0675](#) [62674-201121DLF](#) [62684-36210E9ALF](#) [52746-1671-TR250](#) [10051922-2810EHLF](#) [686322124422](#) [XF3M-](#)
[2915-1B-R100](#) [AYF353125A](#) [AYF530665TA](#) [AYF534065TA](#) [AYF351525](#) [086212040340800+](#) [AYF530365TA](#) [67000-004LF](#)
[006207341915000+](#) [207356-1](#) [67000-003LF](#) [HFW14R-2STE9LF](#) [SFW12R-5STE9LF](#) [SFW18R-1STAE9LF](#) [SFW4R-5STE9LF](#) [52807-0430](#)
[046283021002868+](#) [502250-8027](#) [104267-9617](#) [66987-011LF](#) [HFW8S-2STAE1HLF](#) [67000-008LF](#) [HFW22R-2STE1H1LF](#) [0781271110](#)
[5019511030](#) [200528-0260](#) [5039084120](#) [503908-5120](#) [SFW20R-1STGE5LF](#) [FH12-18S-0.5SH](#) [686116183522](#) [FH64MA-11S-0.25SHW](#)
[686114183522](#) [502078-5362](#) [FH52K-68S-0.5SH](#) [FH26W-23S-0.3SHW\(60\)](#)