

REV	LOCATIONS	DESCRIPTION	DATE	REVSER	APPD

A
B
C
D
E
F

A
B
C
D
E
F

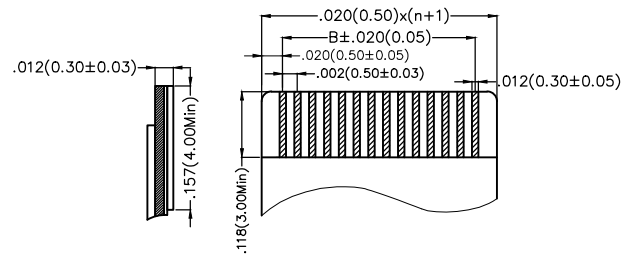
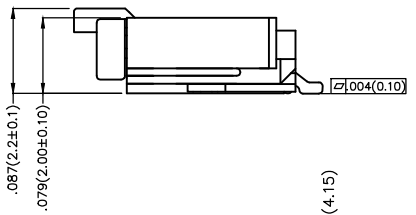
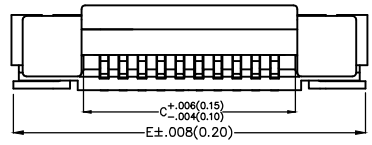
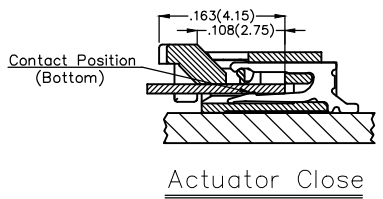
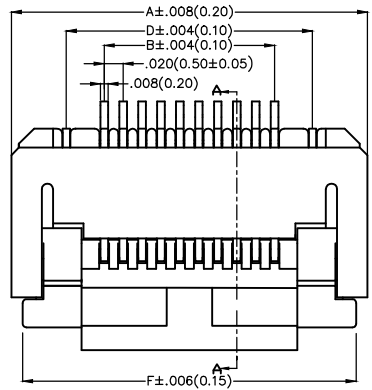

Applicable FFC
Recommended Dimension

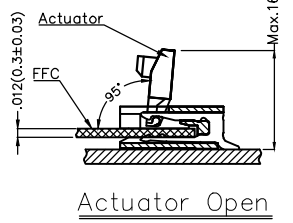
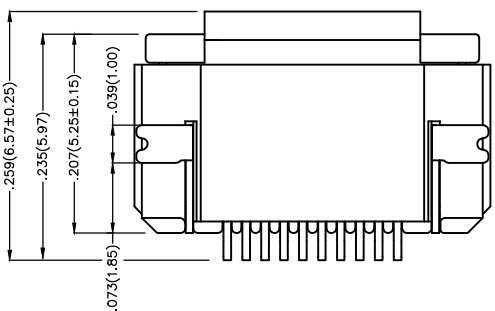

Ordering Information

FFC 050 11 — XX S B B 1 X 4 W5 M
1 2 3 4 5 6 7 8 9 10 11 12

1	Category FFC-FPC	2	Series Number 050-Pitch 0.50mm	3	Distinction No. 11	4	Circuits XX	5	Assemble Layout S-SMT	6	Entry Angle B- 90° Angle
7	Contact Position B-Bottom	8	ZIF 1-ZIF	9	Plating 2-Tin plated 1-Gold plated	10	Material-Resin 4-PA9T	11	Color-Resin W5-Housing: Natural, Actuator: Black	12	Packaging M-Reel

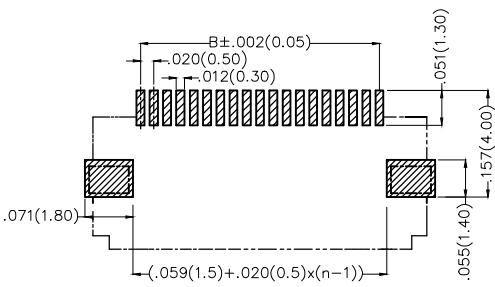

Recommended P.C.Board Layout

<p>THIRD ANGLE PROJECTION</p>	GENERAL TOLERANCES (UNLESS SPECIFIED)		APPROVE BY FRANK	DATE 18/JUN/13	PART NO. FFC05011-XXSBB1X4W5M	ITEM NO. FFC05011	<p>Leader Of Industry</p>
	DESIGN UNITS Inch (metric)	X.±.012(0.30) X.X±.008(0.20)	X'.±5' .X'±2'	CHECKED BY JACOB	DATE 18/JUN/13	TITLE FPC/FFC connector 0.5mm Bottom contact SMT	
SCALE 5:1	SIZE A4	X.XX±.006(0.15) X.XXX±.004(0.10)	.XX'±1' .XXX'±0.5'	DRAWN BY CHERRY	DATE 18/JUN/13	THIS DRAWING CONTAINS INFORMATION THAT IS PROPRIETARY TO TXGA INDUSTRIAL ELECTRONICS(S.Z)CO.,LTD AND SHOULD NOT BE USED WITHOUT WRITTEN PERMISSION	

1 2 3 4 5 6 7 8

REV	LOCATIONS	DESCRIPTION	DATE	REVISED	APPD

A

A

B

B

C

C

D

D



E

E

F

F

Circuits (n)	Part No.	Dimensions(in/mm)					
		A	B	C	D	E	F
4	FFC05011-04SBB1X4W5M	.252(6.40)	.059(1.50)	.102(2.60)	.138(3.50)	.248(6.30)	.228(5.80)
6	FFC05011-06SBB1X4W5M	.291(7.40)	.098(2.50)	.142(3.60)	.177(4.50)	.287(7.30)	.268(6.80)
7	FFC05011-07SBB1X4W5M	.311(7.90)	.118(3.00)	.161(4.10)	.197(5.00)	.307(7.80)	.287(7.30)
8	FFC05011-08SBB1X4W5M	.331(8.40)	.138(3.50)	.171(4.60)	.217(5.50)	.327(8.30)	.307(7.80)
9	FFC05011-09SBB1X4W5M	.350(8.90)	.157(4.00)	.201(5.10)	.236(6.00)	.346(8.80)	.327(8.30)
10	FFC05011-10SBB1X4W5M	.370(9.40)	.177(4.50)	.221(5.60)	.256(6.50)	.366(9.30)	.346(8.80)
11	FFC05011-11SBB1X4W5M	.390(9.90)	.197(5.00)	.240(6.10)	.276(7.00)	.386(9.80)	.366(9.30)
12	FFC05011-12SBB1X4W5M	.409(10.40)	.217(5.50)	.260(6.60)	.295(7.50)	.405(10.30)	.386(9.80)
13	FFC05011-13SBB1X4W5M	.429(10.90)	.236(6.00)	.280(7.10)	.315(8.00)	.425(10.80)	.405(10.30)
14	FFC05011-14SBB1X4W5M	.449(11.40)	.256(6.50)	.299(7.60)	.335(8.50)	.445(11.30)	.425(10.80)
15	FFC05011-15SBB1X4W5M	.469(11.90)	.276(7.00)	.319(8.10)	.354(9.00)	.465(11.80)	.445(11.30)
16	FFC05011-16SBB1X4W5M	.488(12.40)	.295(7.50)	.339(8.60)	.374(9.50)	.484(12.30)	.465(11.80)
17	FFC05011-17SBB1X4W5M	.508(12.90)	.315(8.00)	.359(9.10)	.394(10.00)	.504(12.80)	.484(12.30)
18	FFC05011-18SBB1X4W5M	.528(13.40)	.335(8.50)	.378(9.60)	.413(10.50)	.524(13.30)	.504(12.80)
20	FFC05011-20SBB1X4W5M	.567(14.40)	.374(9.50)	.417(10.60)	.453(11.50)	.563(14.30)	.543(13.80)
21	FFC05011-21SBB1X4W5M	.587(14.90)	.394(10.00)	.437(11.10)	.472(12.00)	.583(14.80)	.563(14.30)
22	FFC05011-22SBB1X4W5M	.606(15.40)	.413(10.50)	.457(11.60)	.492(12.50)	.602(15.30)	.583(14.80)
23	FFC05011-23SBB1X4W5M	.626(15.90)	.433(11.00)	.476(12.10)	.512(13.00)	.622(15.80)	.602(15.30)
24	FFC05011-24SBB1X4W5M	.646(16.40)	.453(11.50)	.496(12.60)	.531(13.50)	.642(16.30)	.622(15.80)
25	FFC05011-25SBB1X4W5M	.665(16.90)	.472(12.00)	.516(13.10)	.551(14.00)	.661(16.80)	.642(16.30)
26	FFC05011-26SBB1X4W5M	.685(17.40)	.492(12.50)	.535(13.60)	.571(14.50)	.681(17.30)	.661(16.80)
28	FFC05011-28SBB1X4W5M	.724(18.40)	.531(13.50)	.575(14.60)	.610(15.50)	.720(18.30)	.701(17.80)
30	FFC05011-30SBB1X4W5M	.764(19.40)	.571(14.50)	.614(15.60)	.650(16.50)	.760(19.30)	.740(18.80)
32	FFC05011-32SBB1X4W5M	.803(20.40)	.610(15.50)	.654(16.60)	.689(17.50)	.799(20.30)	.779(19.80)
33	FFC05011-33SBB1X4W5M	.823(20.90)	.630(16.00)	.673(17.10)	.709(18.00)	.819(20.80)	.799(20.30)
34	FFC05011-34SBB1X4W5M	.843(21.40)	.650(16.50)	.693(17.60)	.728(18.50)	.839(21.30)	.819(20.80)
35	FFC05011-35SBB1X4W5M	.862(21.90)	.669(17.00)	.713(18.10)	.748(19.00)	.858(21.80)	.839(21.30)
36	FFC05011-36SBB1X4W5M	.882(22.40)	.689(17.50)	.732(18.60)	.768(19.50)	.878(22.30)	.858(21.80)

 THIRD ANGLE PROJECTION	GENERAL TOLERANCES (UNLESS SPECIFIED)		APPROVE BY FRANK	DATE 18/JUN/13	PART NO. FFC05011-XXSBB1X4W5M	ITEM NO. FFC05011	 Leader Of Industry	
	X.±.012(0.30)	X.±5'	CHECKED BY JACOB	DATE 18/JUN/13	TITLE FFC/FFC connector 0.5mm Bottom contact SMT			REV 0
	DESIGN UNITS Inch (metric)	X.X±.008(0.20)	.X'±2'	DRAWN BY CHERRY	DATE 18/JUN/13	THIS DRAWING CONTAINS INFORMATION THAT IS PROPRIETARY TO TXGA INDUSTRIAL ELECTRONICS(S.Z)CO.,LTD AND SHOULD NOT BE USED WITHOUT WRITTEN PERMISSION		
	SCALE 5:1	SIZE A4	X.XX±.006(0.15)	.XX'±1'	X.XXX±.004(0.10)	.XXX'±0.5'		

1 2 3 4 5 6 7 8

1 2 3 4 5 6 7 8

REV	LOCATIONS	DESCRIPTION	DATE	REVISER	APPD

A
B
C
D
E
F

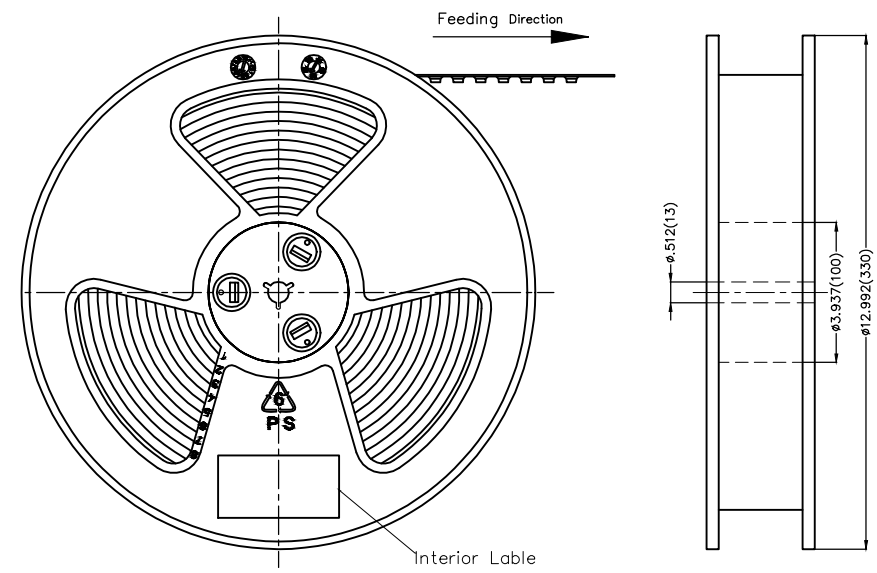

- Note:
1. 10 sprocket hole cumulative tolerance ± 0.2
 2. Carrier camber is within 1.0mm in 250mm
 3. Material: White Conductive polystyrene Alloy 100% recyclable
 4. All dimensions meet EIA-481-3 requirements
 5. Peel off force of cover tape & carrier tape: 20g~130g(0.2N~1.3N)
 6. Component load per 13" reel: 2,000 pcs

Circuits (n)	Dimensions(in/mm)		
	A	B	C
4	.630(16.0)	.295(7.5)	—
5~21	.945(24.0)	.453(11.5)	—
22~32	1.260(32.0)	.561(14.25)	1.033(28.50)
33~36	1.732(44.0)	.797(20.25)	1.594(40.50)

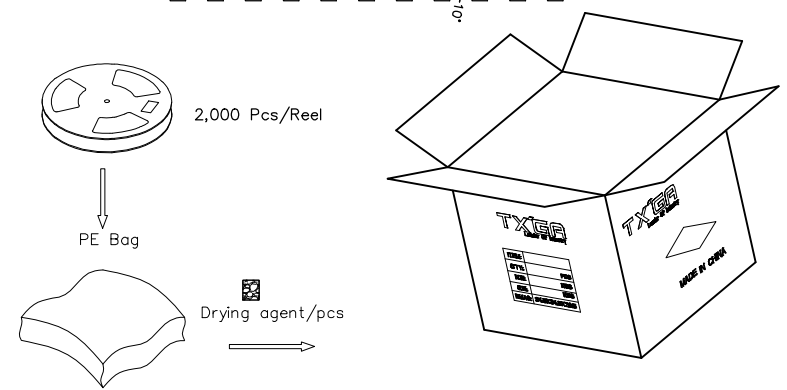
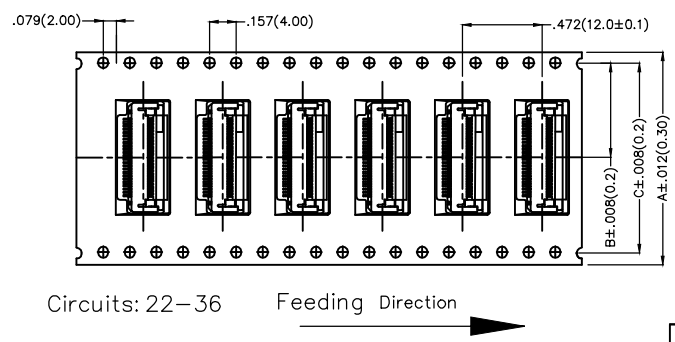
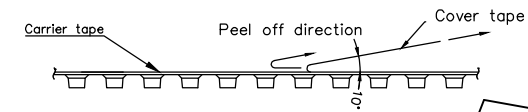
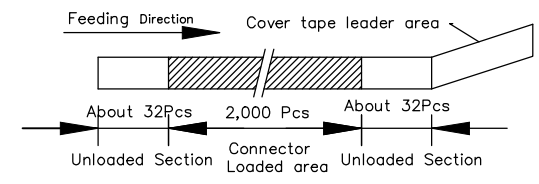
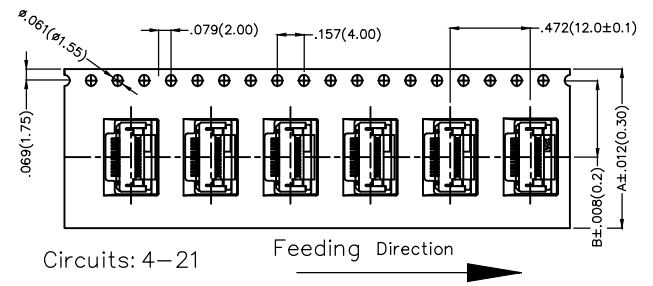

 THIRD ANGLE PROJECTION	GENERAL TOLERANCES (UNLESS SPECIFIED)		APPROVE BY	DATE	PART NO.	ITEM NO.	 Leader Of Industry
	X. \pm .012(0.30)	X. \pm 5'	FRANK	18/JUN/13	FFC05011-XXSBB1X4W5M	FFC05011	
	X.X \pm .008(0.20)	.X \pm 2'	CHECKED BY	DATE	TITLE		REV 0 SHEET NO. 3/3
	X.XX \pm .006(0.15)	.XX \pm 1'	JACOB	18/JUN/13	FPC/FFC connector 0.5mm Bottom contact SMT		
SCALE	SIZE	X.XXX \pm .004(0.10)	.XXX \pm 0.5'	DRAWN BY	DATE	THIS DRAWING CONTAINS INFORMATION THAT IS PROPRIETARY TO TXGA INDUSTRIAL ELECTRONICS(S.Z)CO.,LTD AND SHOULD NOT BE USED WITHOUT WRITTEN PERMISSION	
5:1	A4			CHERRY	18/JUN/13		

1 2 3 4 5 6 7 8

X-ON Electronics

Largest Supplier of Electrical and Electronic Components

Click to view similar products for [FFC & FPC Connectors](#) category:

Click to view products by [TXGA](#) manufacturer:

Other Similar products are found below :

[HFW11R-1STE1H1LF](#) [FH29B-100S-0.2SHW\(99\)](#) [FA5S008HP1](#) [FH29B-120S-0.2SHW\(99\)](#) [FH29B-80S-0.2SHW\(99\)](#) [FHS-16](#) [FPH-2022G](#)
[52610-1075](#) [52610-1275](#) [52610-1934](#) [XF3M\(1\)-1415-1B-R100](#) [501864-3091-TR225](#) [0525594033](#) [086210010340800](#) [086222026001800](#)
[52271-2869-CUT-TAPE](#) [62674-201121DLF](#) [62684-36210E9ALF](#) [52610-1675](#) [52746-1671-TR250](#) [10051922-2810EHLF](#) [6-520415-9](#)
[BD021-09A-A1-0350-0200-0550-LD](#) [SFV6R-1STE9HLF](#) [XF3M-2915-1B-R100](#) [1658549-1](#) [62674-221121ALF](#) [46214008010800](#)
[046298003000883](#) [151660622](#) [842-816-2630-035](#) [AYF530665TA](#) [AYF351525](#) [046296011930846+](#) [AYF352325A](#) [046254020000800+](#)
[FH19C-13S-0.5SH\(99\)](#) [FH39J-51S-0.3SHW\(99\)](#) [AYF355125A](#) [AYF530365TA](#) [FH29B-44S-0.2SHW\(99\)](#) [SFW5R-2STAE9LF](#) [AYF351125A](#)
[AYF350725A](#) [62684-502100AHLF](#) [FH39-61S-0.3SHW\(99\)](#) [AYF414035A](#) [10064555-172520HLF](#) [AYF212335A](#) [504754-2500](#)