

REV	LOCATIONS	DESCRIPTION	DATE	REVISER	APPD

A
B
C
D
E
F

A
B
C
D
E
F

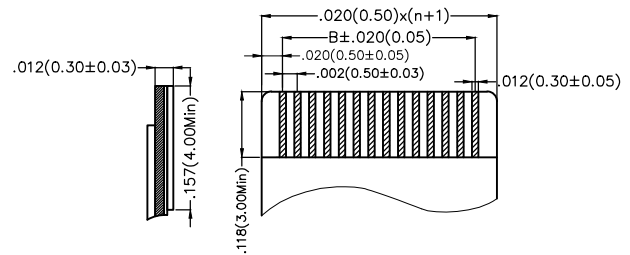
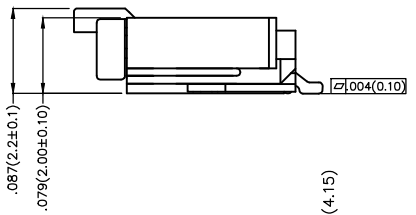
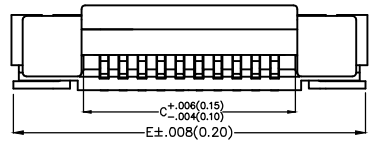
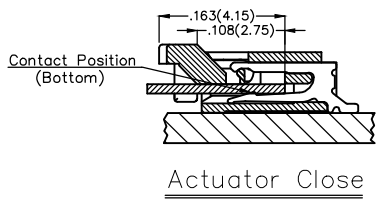
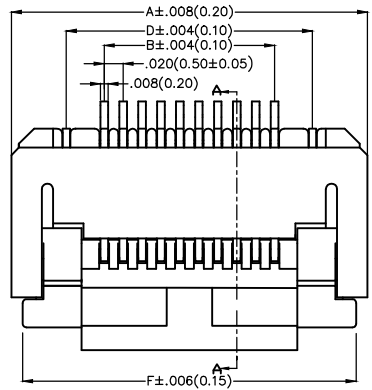

Applicable FFC
Recommended Dimension

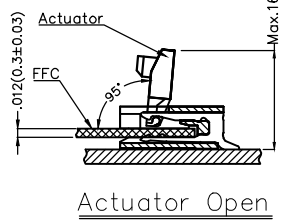
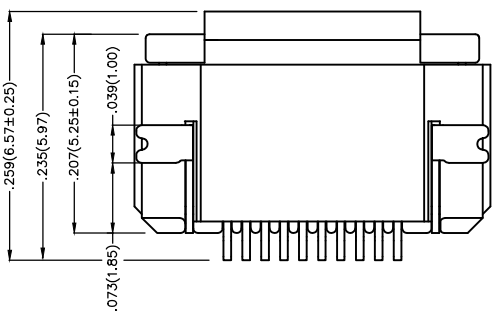

Ordering Information

FFC 050 11 — XX S B B 1 X 4 W5 M
1 2 3 4 5 6 7 8 9 10 11 12

1 Category FFC-FPC	2 Series Number 050-Pitch 0.50mm	3 Distinction No. 11	4 Circuits XX	5 Assemble Layout S-SMT	6 Entry Angle B- 90° Angle
7 Contact Position B-Bottom	8 ZIF 1-ZIF	9 Plating 2-Tin plated 1-Gold plated	10 Material-Resin 4-PA9T	11 Color-Resin W5-Housing: Natural, Actuator: Black	12 Packaging M-Reel

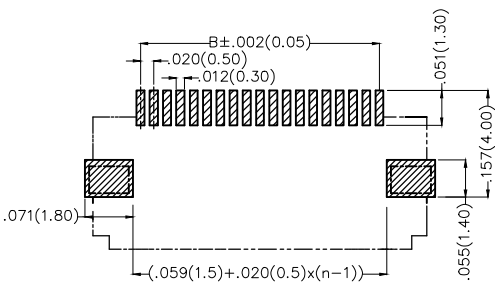

Recommended P.C.Board Layout

 THIRD ANGLE PROJECTION DESIGN UNITS Inch (metric) SCALE 5:1 SIZE A4	GENERAL TOLERANCES (UNLESS SPECIFIED)		APPROVE BY FRANK	DATE 18/JUN/13	PART NO. FFC05011-XXSBB1X4W5M	ITEM NO. FFC05011	 Leader Of Industry	
	X.±.012(0.30)	X'.±5'	CHECKED BY JACOB	DATE 18/JUN/13	TITLE FPC/FFC connector 0.5mm Bottom contact SMT			REV 0
	X.X±.008(0.20)	.X'±2'	DRAWN BY CHERRY	DATE 18/JUN/13	THIS DRAWING CONTAINS INFORMATION THAT IS PROPRIETARY TO TXGA INDUSTRIAL ELECTRONICS(S.Z)CO.,LTD AND SHOULD NOT BE USED WITHOUT WRITTEN PERMISSION			
	X.XX±.006(0.15)	.XX'±1'						
	X.XXX±.004(0.10)	.XXX'±0.5'						

REV	LOCATIONS	DESCRIPTION	DATE	REVISED	APPD

A

A

B

B

C

C

D

D



E

E

F

F

Circuits (n)	Part No.	Dimensions(in/mm)					
		A	B	C	D	E	F
4	FFC05011-04SBB1X4W5M	.252(6.40)	.059(1.50)	.102(2.60)	.138(3.50)	.248(6.30)	.228(5.80)
6	FFC05011-06SBB1X4W5M	.291(7.40)	.098(2.50)	.142(3.60)	.177(4.50)	.287(7.30)	.268(6.80)
7	FFC05011-07SBB1X4W5M	.311(7.90)	.118(3.00)	.161(4.10)	.197(5.00)	.307(7.80)	.287(7.30)
8	FFC05011-08SBB1X4W5M	.331(8.40)	.138(3.50)	.171(4.60)	.217(5.50)	.327(8.30)	.307(7.80)
9	FFC05011-09SBB1X4W5M	.350(8.90)	.157(4.00)	.201(5.10)	.236(6.00)	.346(8.80)	.327(8.30)
10	FFC05011-10SBB1X4W5M	.370(9.40)	.177(4.50)	.221(5.60)	.256(6.50)	.366(9.30)	.346(8.80)
11	FFC05011-11SBB1X4W5M	.390(9.90)	.197(5.00)	.240(6.10)	.276(7.00)	.386(9.80)	.366(9.30)
12	FFC05011-12SBB1X4W5M	.409(10.40)	.217(5.50)	.260(6.60)	.295(7.50)	.405(10.30)	.386(9.80)
13	FFC05011-13SBB1X4W5M	.429(10.90)	.236(6.00)	.280(7.10)	.315(8.00)	.425(10.80)	.405(10.30)
14	FFC05011-14SBB1X4W5M	.449(11.40)	.256(6.50)	.299(7.60)	.335(8.50)	.445(11.30)	.425(10.80)
15	FFC05011-15SBB1X4W5M	.469(11.90)	.276(7.00)	.319(8.10)	.354(9.00)	.465(11.80)	.445(11.30)
16	FFC05011-16SBB1X4W5M	.488(12.40)	.295(7.50)	.339(8.60)	.374(9.50)	.484(12.30)	.465(11.80)
17	FFC05011-17SBB1X4W5M	.508(12.90)	.315(8.00)	.359(9.10)	.394(10.00)	.504(12.80)	.484(12.30)
18	FFC05011-18SBB1X4W5M	.528(13.40)	.335(8.50)	.378(9.60)	.413(10.50)	.524(13.30)	.504(12.80)
20	FFC05011-20SBB1X4W5M	.567(14.40)	.374(9.50)	.417(10.60)	.453(11.50)	.563(14.30)	.543(13.80)
21	FFC05011-21SBB1X4W5M	.587(14.90)	.394(10.00)	.437(11.10)	.472(12.00)	.583(14.80)	.563(14.30)
22	FFC05011-22SBB1X4W5M	.606(15.40)	.413(10.50)	.457(11.60)	.492(12.50)	.602(15.30)	.583(14.80)
23	FFC05011-23SBB1X4W5M	.626(15.90)	.433(11.00)	.476(12.10)	.512(13.00)	.622(15.80)	.602(15.30)
24	FFC05011-24SBB1X4W5M	.646(16.40)	.453(11.50)	.496(12.60)	.531(13.50)	.642(16.30)	.622(15.80)
25	FFC05011-25SBB1X4W5M	.665(16.90)	.472(12.00)	.516(13.10)	.551(14.00)	.661(16.80)	.642(16.30)
26	FFC05011-26SBB1X4W5M	.685(17.40)	.492(12.50)	.535(13.60)	.571(14.50)	.681(17.30)	.661(16.80)
28	FFC05011-28SBB1X4W5M	.724(18.40)	.531(13.50)	.575(14.60)	.610(15.50)	.720(18.30)	.701(17.80)
30	FFC05011-30SBB1X4W5M	.764(19.40)	.571(14.50)	.614(15.60)	.650(16.50)	.760(19.30)	.740(18.80)
32	FFC05011-32SBB1X4W5M	.803(20.40)	.610(15.50)	.654(16.60)	.689(17.50)	.799(20.30)	.779(19.80)
33	FFC05011-33SBB1X4W5M	.823(20.90)	.630(16.00)	.673(17.10)	.709(18.00)	.819(20.80)	.799(20.30)
34	FFC05011-34SBB1X4W5M	.843(21.40)	.650(16.50)	.693(17.60)	.728(18.50)	.839(21.30)	.819(20.80)
35	FFC05011-35SBB1X4W5M	.862(21.90)	.669(17.00)	.713(18.10)	.748(19.00)	.858(21.80)	.839(21.30)
36	FFC05011-36SBB1X4W5M	.882(22.40)	.689(17.50)	.732(18.60)	.768(19.50)	.878(22.30)	.858(21.80)

 <p>THIRD ANGLE PROJECTION</p>	GENERAL TOLERANCES (UNLESS SPECIFIED)		APPROVE BY	DATE	PART NO.	ITEM NO.	 <p>Leader Of Industry</p>
	X.±.012(0.30)	X.±5'	FRANK	18/JUN/13	FFC05011-XXSBB1X4W5M	FFC05011	
	X.X±.008(0.20)	.X'±2'	CHECKED BY	DATE	TITLE		
	X.XX±.006(0.15)	.XX'±1'	JACOB	18/JUN/13	FFC/FFC connector 0.5mm Bottom contact SMT		
SCALE	SIZE	X.XXX±.004(0.10)	.XXX'±0.5'	DRAWN BY	DATE	THIS DRAWING CONTAINS INFORMATION THAT IS PROPRIETARY TO TXGA INDUSTRIAL ELECTRONICS(S.Z)CO.,LTD AND SHOULD NOT BE USED WITHOUT WRITTEN PERMISSION	
5:1	A4			CHERRY	18/JUN/13	REV 0	SHEET NO. 2/3

REV	LOCATIONS	DESCRIPTION	DATE	REVISED	APPD

A
B
C
D
E
F

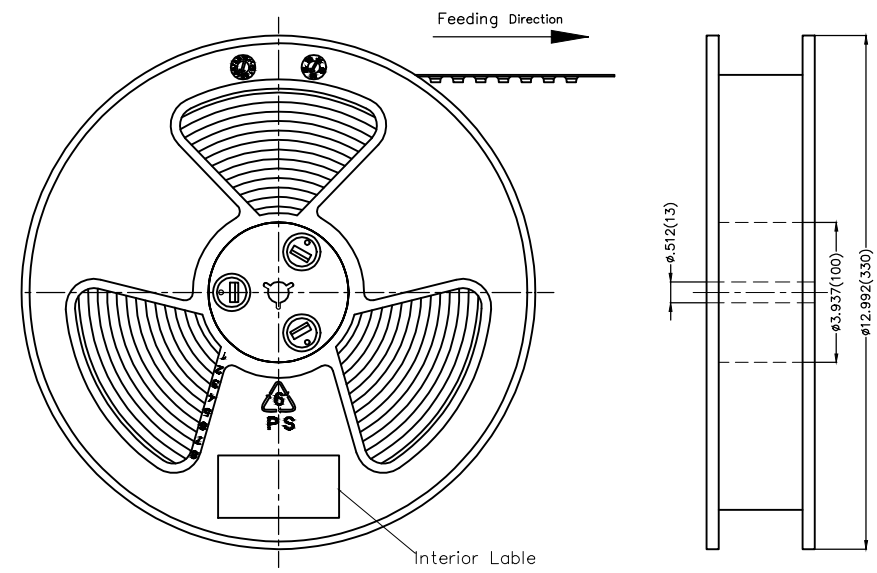

- Note:
1. 10 sprocket hole cumulative tolerance ± 0.2
 2. Carrier camber is within 1.0mm in 250mm
 3. Material: White Conductive polystyrene Alloy 100% recyclable
 4. All dimensions meet EIA-481-3 requirements
 5. Peel off force of cover tape & carrier tape: 20g~130g(0.2N~1.3N)
 6. Component load per 13" reel: 2,000 pcs

Circuits (n)	Dimensions(in/mm)		
	A	B	C
4	.630(16.0)	.295(7.5)	—
5~21	.945(24.0)	.453(11.5)	—
22~32	1.260(32.0)	.561(14.25)	1.033(28.50)
33~36	1.732(44.0)	.797(20.25)	1.594(40.50)

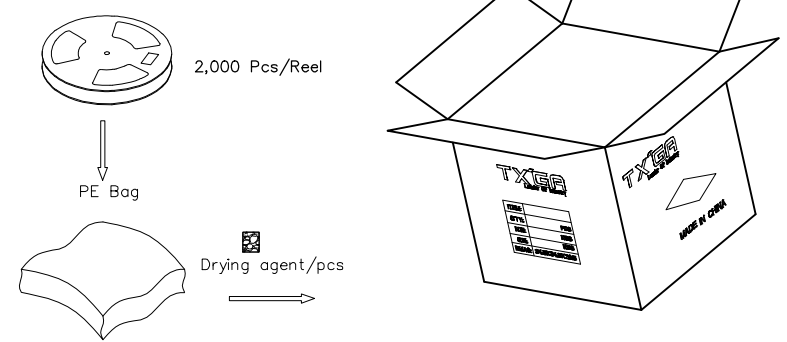
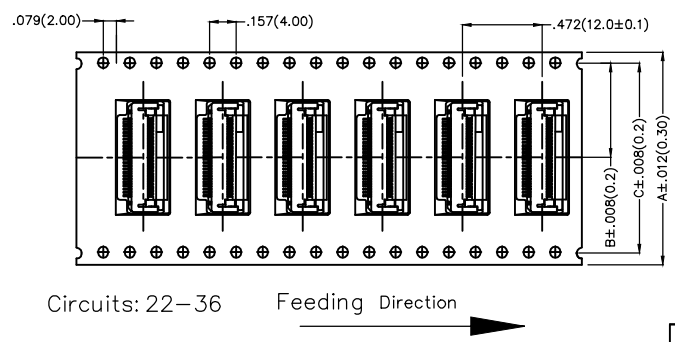
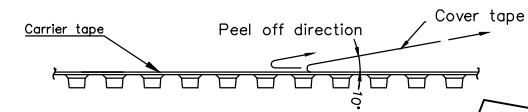
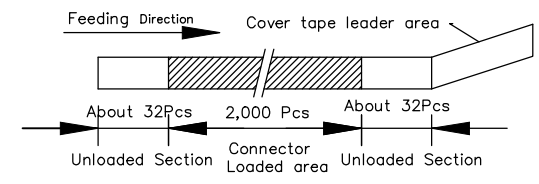
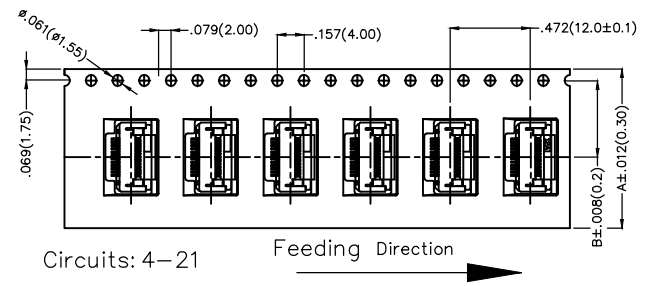

<p>THIRD ANGLE PROJECTION</p>	GENERAL TOLERANCES (UNLESS SPECIFIED)		APPROVE BY	DATE	PART NO.	ITEM NO.	<p>Leader Of Industry</p>
	X.±.012(0.30)	X.±5'	FRANK	18/JUN/13	FFC05011-XXSBB1X4W5M	FFC05011	
	X.X±.008(0.20)	.X'±2'	CHECKED BY	DATE	TITLE		REV 0
	X.XX±.006(0.15)	.XX'±1'	JACOB	18/JUN/13	FPC/FFC connector 0.5mm Bottom contact SMT		SHEET NO. 3/3
SCALE	SIZE	X.XXX±.004(0.10)	.XXX'±0.5'	DRAWN BY	DATE	THIS DRAWING CONTAINS INFORMATION THAT IS PROPRIETARY TO TXGA INDUSTRIAL ELECTRONICS(S.Z)CO.,LTD AND SHOULD NOT BE USED WITHOUT WRITTEN PERMISSION	
5:1	A4			CHERRY	18/JUN/13		

X-ON Electronics

Largest Supplier of Electrical and Electronic Components

Click to view similar products for [FFC & FPC Connectors](#) category:

Click to view products by [TXGA](#) manufacturer:

Other Similar products are found below :

[HFW11R-1STE1H1LF](#) [FH29B-100S-0.2SHW\(99\)](#) [FA5S008HP1](#) [FH29B-120S-0.2SHW\(99\)](#) [FH29B-80S-0.2SHW\(99\)](#) [FHS-16](#) [FPH-2022G](#)
[52610-1075](#) [52610-1275](#) [52610-1934](#) [XF3M\(1\)-1415-1B-R100](#) [501864-3091-TR225](#) [0525594033](#) [086210010340800](#) [086222026001800](#)
[52271-2869-CUT-TAPE](#) [62674-201121DLF](#) [62684-36210E9ALF](#) [52610-1675](#) [52746-1671-TR250](#) [10051922-2810EHLF](#) [6-520415-9](#)
[BD021-09A-A1-0350-0200-0550-LD](#) [SFV6R-1STE9HLF](#) [XF3M-2915-1B-R100](#) [1658549-1](#) [62674-221121ALF](#) [46214008010800](#)
[046298003000883](#) [151660622](#) [842-816-2630-035](#) [AYF530665TA](#) [AYF351525](#) [046296011930846+](#) [AYF352325A](#) [046254020000800+](#)
[FH19C-13S-0.5SH\(99\)](#) [FH39J-51S-0.3SHW\(99\)](#) [AYF355125A](#) [AYF530365TA](#) [FH29B-44S-0.2SHW\(99\)](#) [SFW5R-2STAE9LF](#) [AYF351125A](#)
[AYF350725A](#) [62684-502100AHLF](#) [FH39-61S-0.3SHW\(99\)](#) [AYF414035A](#) [10064555-172520HLF](#) [AYF212335A](#) [504754-2500](#)